



Arkay Windows

TECHNICAL DOCUMENTS

EdgeGLIDE +

EdgeGLIDE +



EDGEGLIDE+

THE AMAZINGLY
SLEEK NEW INLINE
SLIDING DOOR

Choose your design, choose your view. EdgeGlide is the sleek sliding door which combines top quality, colour-matched hardware with elegant design. So the look of your door can match the look of your outdoors.

Modern Square Look

Ultra Slim 35mm Interlock

Up to 2.2m x 2.6m per panel

Stylish Colour-Matched Hardware

U-Value From 1.2 W/m²K

Double or Triple Glazing

Multi-Point Locking

70mm Frame Depth For Easy Replacement

Kit Frame and Sash Option For Full Site-Assembly

EDGEGLIDE+

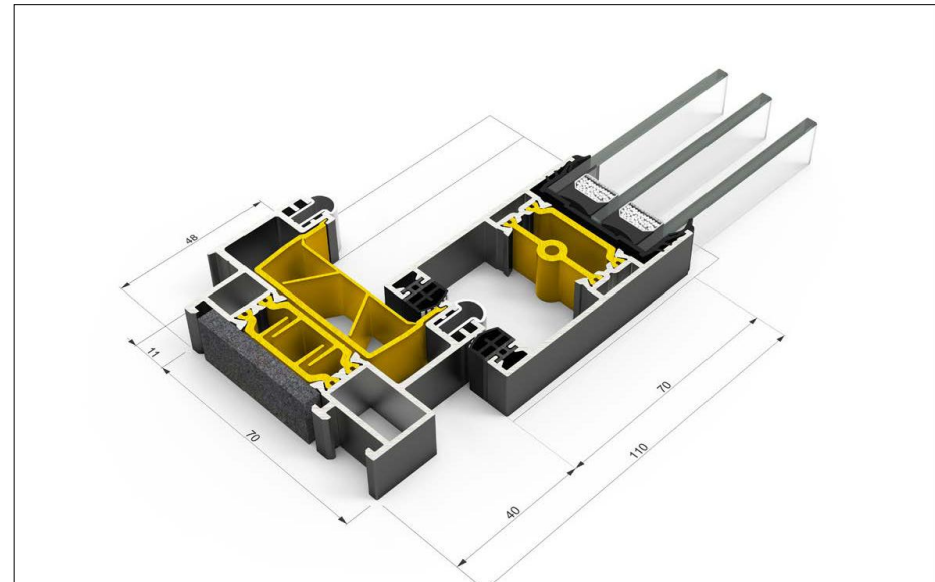

Size Limits

Maximum Panel Width 2200 mm

Maximum Panel Height 2600 mm

Maximum Panel Weight 240 kg

THRESHOLD HEIGHT	48 mm	
GLAZING THICKNESS	14 - 36 mm	
GLAZING METHOD	Wrap-Around	
GLAZING	Double or Triple	
SIGHTLINE (TYPICAL)	35 mm	
FRAME DEPTH	2 RAIL	70 mm
FRAME DEPTH	3 RAIL	126 mm

PERFORMANCE	
U-VALUE	From 1.2 W/m ² K
AIR PERMEABILITY	Class 4
WATER TIGHTNESS	Class 7A
WIND RESISTANCE	Class C5
ENHANCED SECURITY	Multi-Point Locking
MAXIMUM ACOUSTIC INSULATION	40 dB Rw

EdgeGLIDE+ - Contents

- 1.0 Typical Elevations
- 2.0 Standard Profiles
- 3.0 Typical Sections
 - 3.1 Duo Frame - Locking Jamb
 - 3.2 Tri Frame - Locking Jamb
 - 3.3 Duo Frame - Sliding Panel Threshold
 - 3.4 Tri Frame - Fixed Panel Threshold
 - 3.5 Tri Frame - Sliding Panel Threshold
 - 3.6 Duo Frame - Sliding Panel Head
 - 3.7 Tri Frame - Sliding Panel Head
 - 3.8 Interlocks
 - 3.8a Standard
 - 3.8b Reinforced
 - 3.9 Meeting Section
 - 3.10 Duo Frame - Cill Options
 - 3.11 Tri Frame - Cill Options
 - 3.12 Frame Extenders & Trickle Vent

EdgeGLIDE+ - Contents

DUAL TRACK
APPLICABLE FOR IN-LINE SLIDING

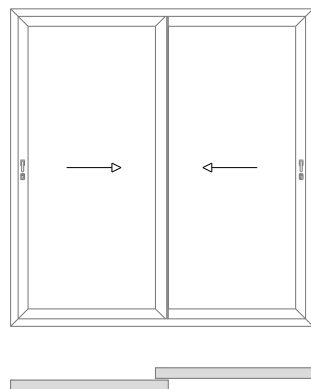

DUO RAIL
XX

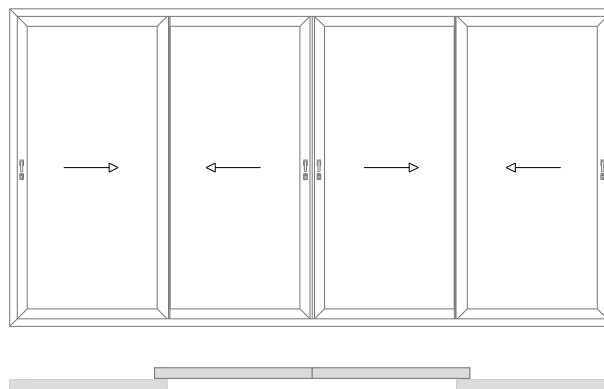

DUO RAIL
XXXX

TRIPLE TRACK
APPLICABLE FOR IN-LINE SLIDING

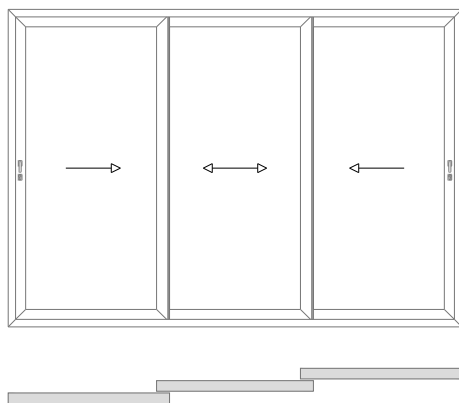

TRI RAIL
XXX

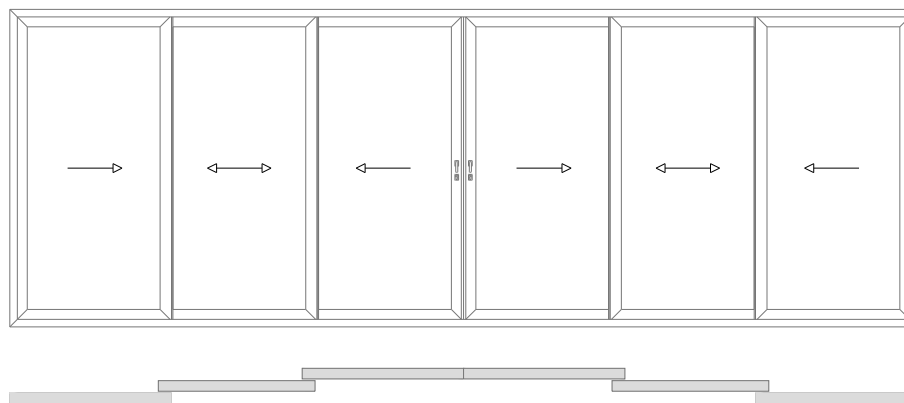

TRI RAIL
XXXXXX

EdgeGLIDE+ - Profiles

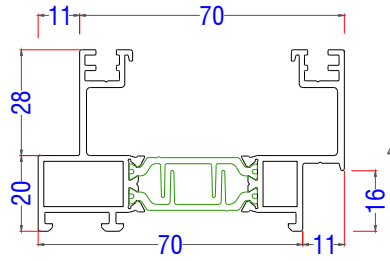

4930 - Duo Frame - Track

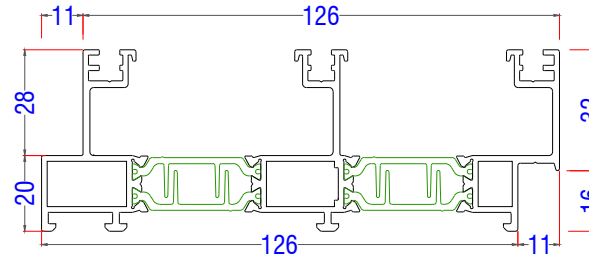

4940 - Tri Fame - Track

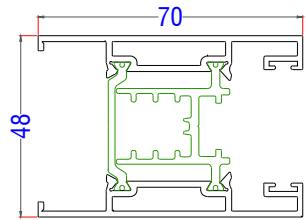

4922- Lateral Sash Profile

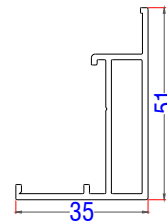

4925-01- Shallow Interlock

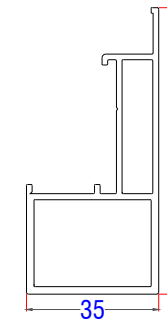

4926-01- Reinforced Interlock

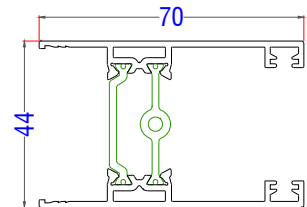

4921 - Top / Bearing Sash Profile

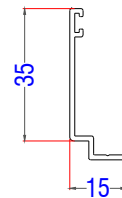

770229 - Frame Extension Add On 35mm

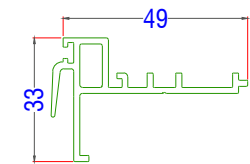

4259 - Interlock Seam Profile
(4256)

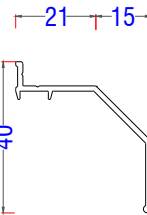

4910- Drip nose

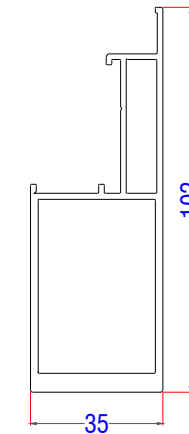

4927-01- Reinforced Interlock

EdgeGLIDE+ - Profiles

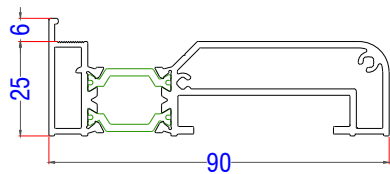

3836 - Stub Cill 90mm

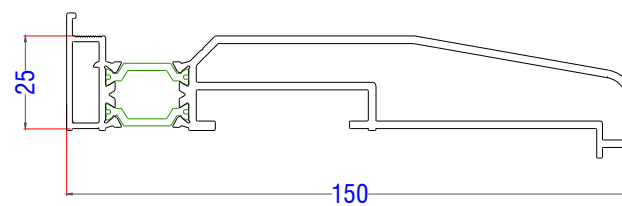

3735 - Drop Nose Cill 150mm

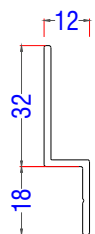

P-00-520 - Z-Profile

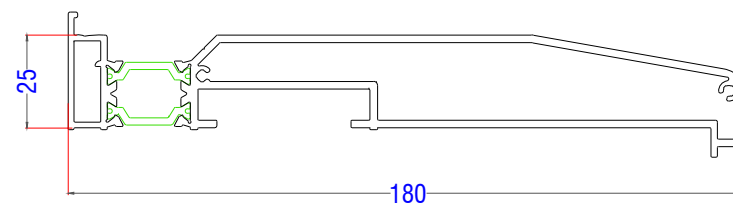

3837 - Drop Nose Cill 180mm

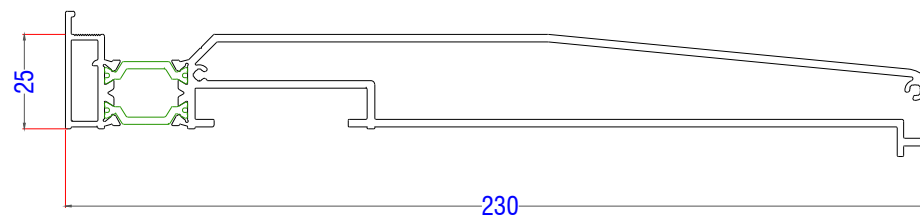

3838 - Drop Nose Cill 230mm

EdgeGLIDE+ - Typical Sections

Duo Frame - Locking Jamb

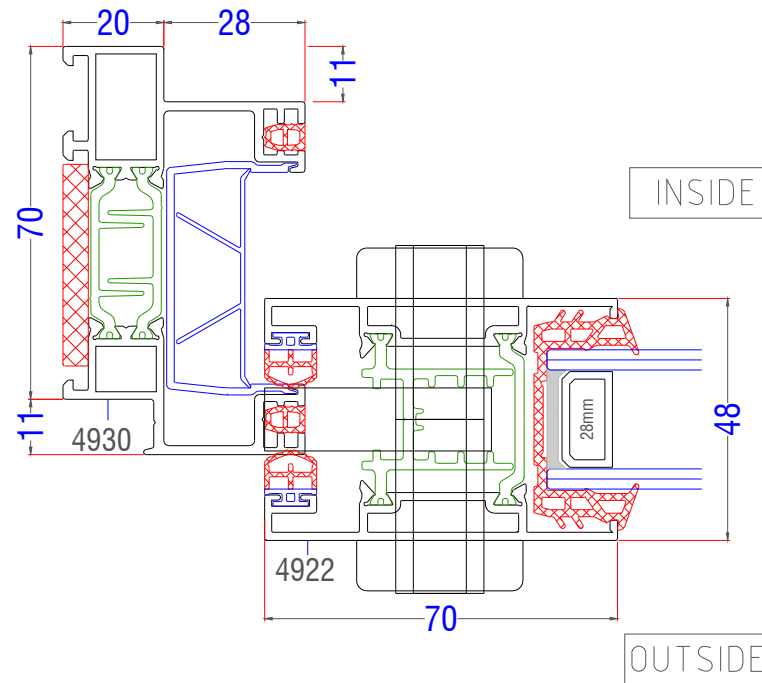
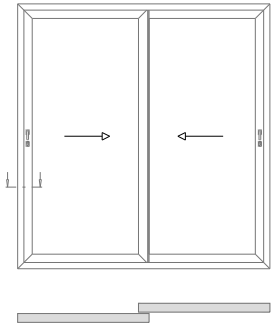

EdgeGLIDE+ - Typical Sections

Tri Frame - Locking Jamb

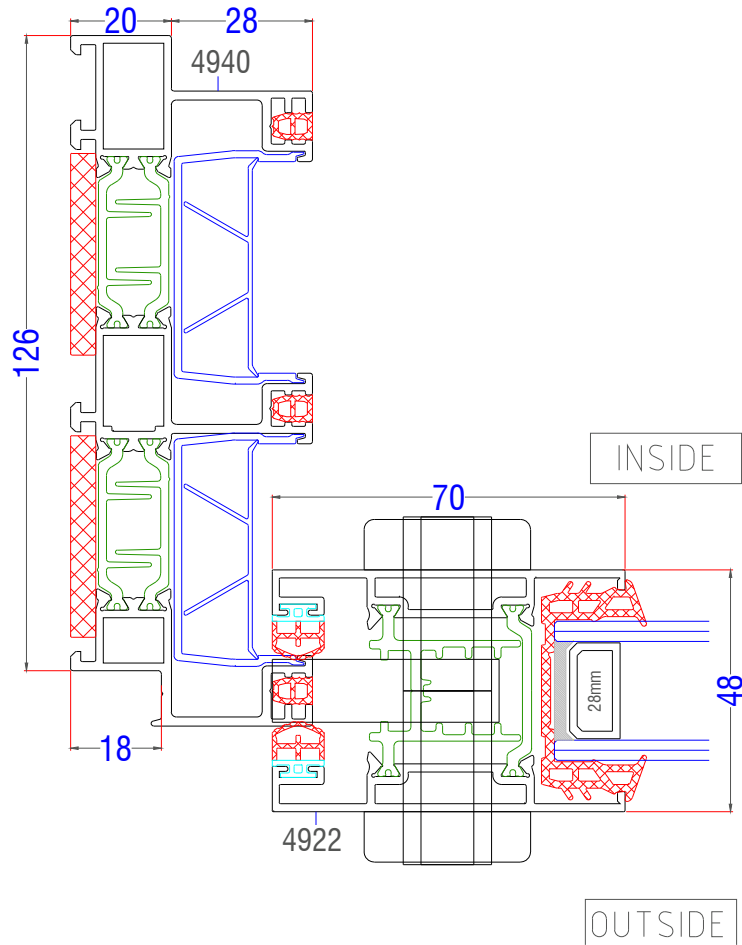
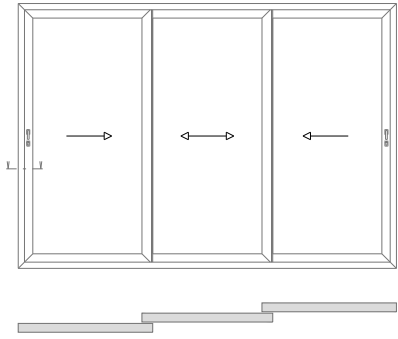

EdgeGLIDE+ - Typical Sections

Duo Frame - Sliding Panel Threshold

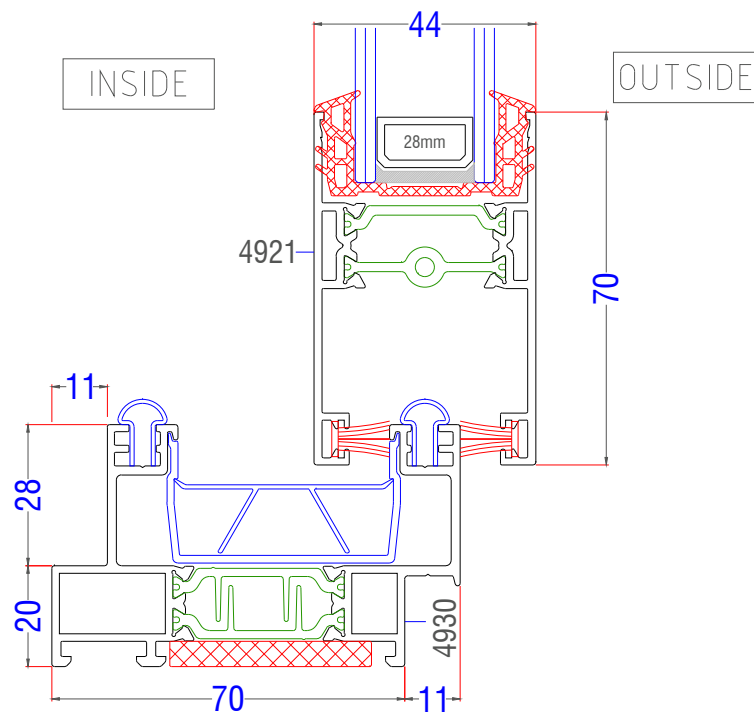
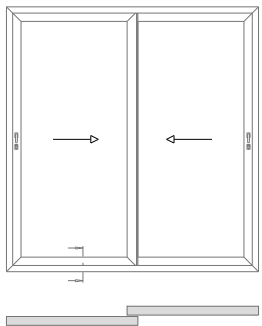

EdgeGLIDE+ - Typical Sections

Tri Frame - Sliding Panel Threshold

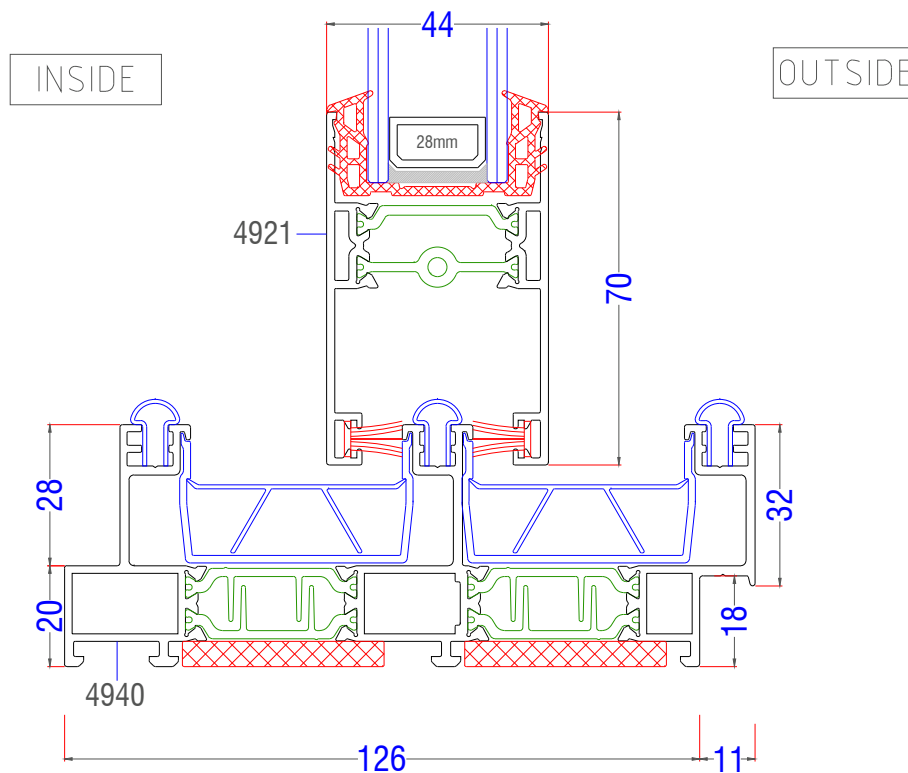
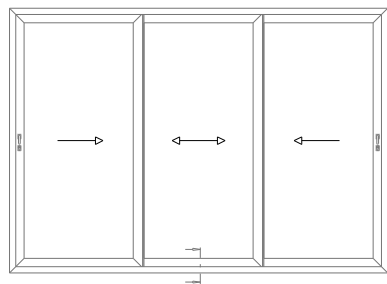

EdgeGLIDE+ - Typical Sections

Duo Frame - Sliding Panel Head

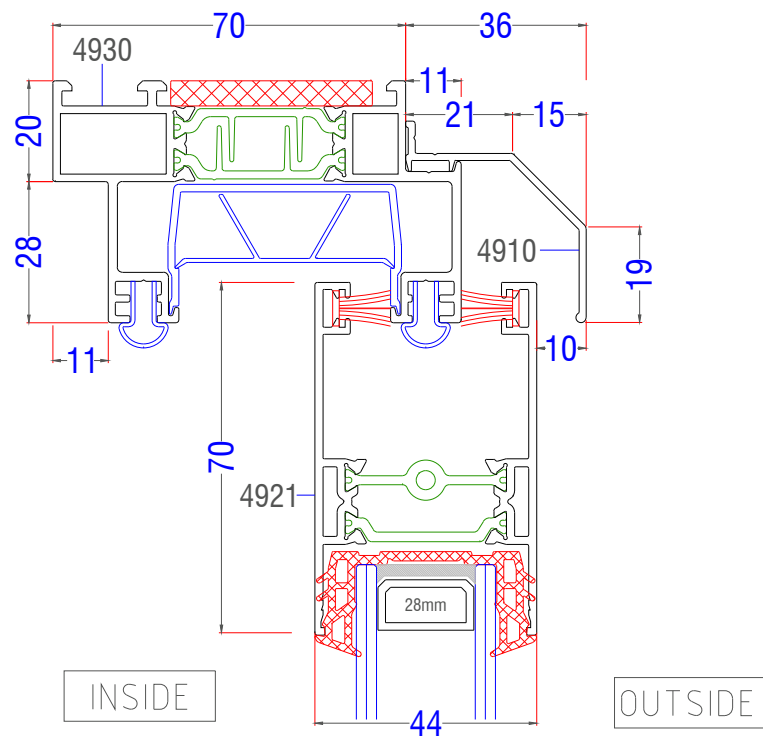
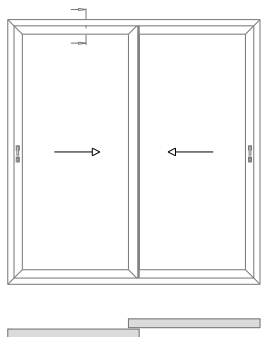

EdgeGLIDE+ - Typical Sections

Tri Frame - Sliding Panel Head

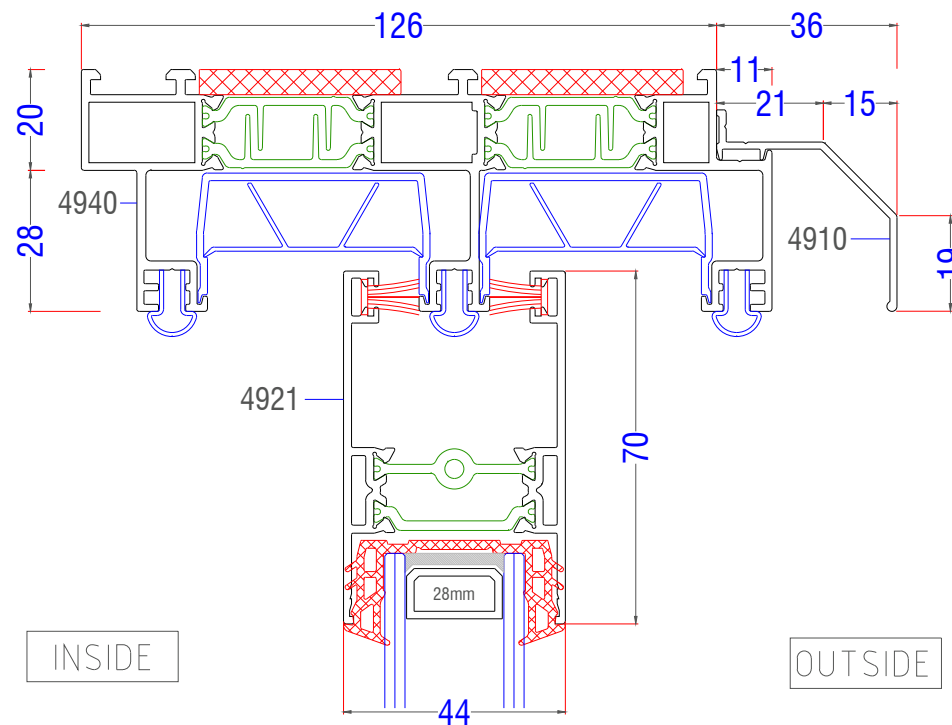
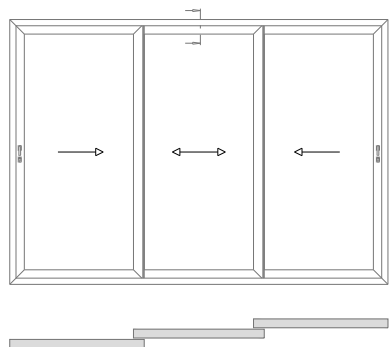

EdgeGLIDE+ - Typical Sections

Interlock - Standard

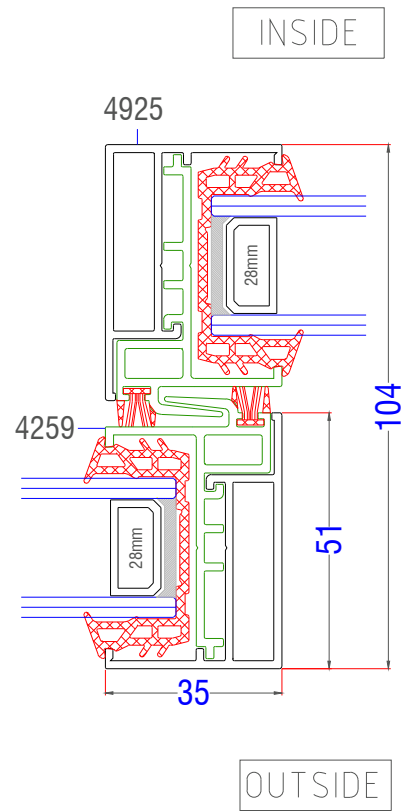
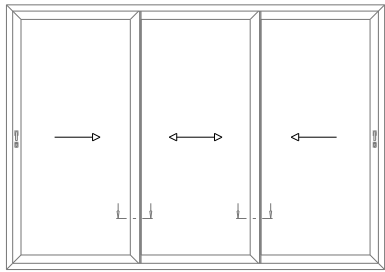
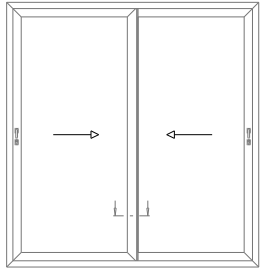

EdgeGLIDE+ - Typical Sections

Interlock - Standard

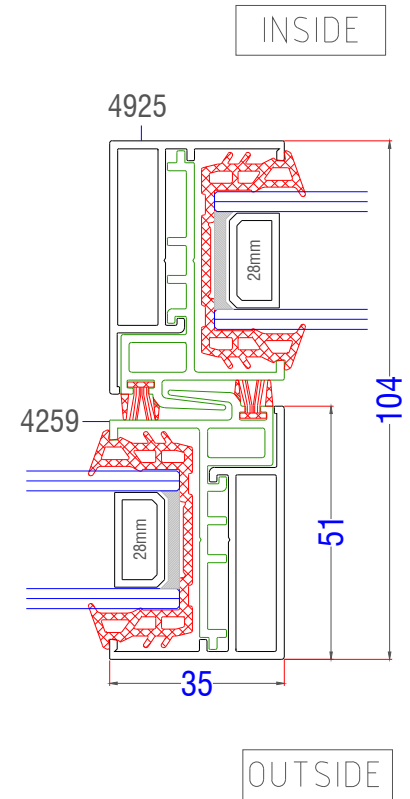
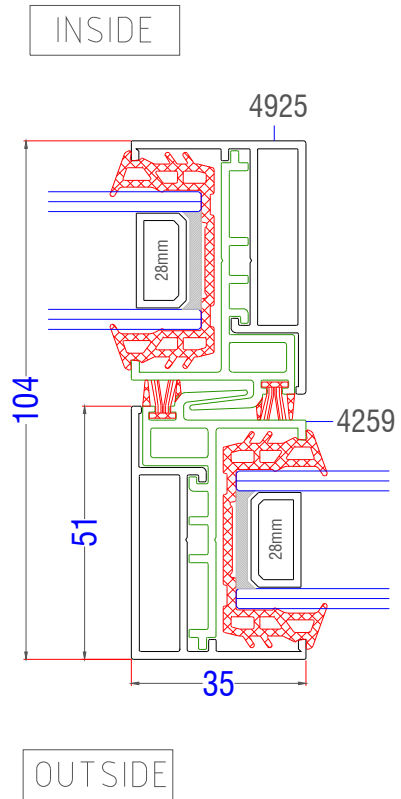
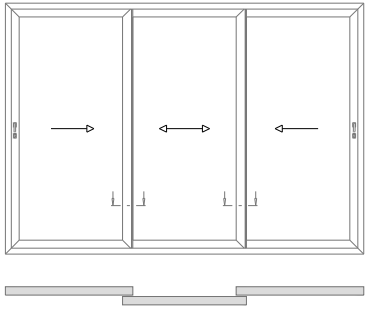

EdgeGLIDE+ - Typical Sections

Interlock Reinforced

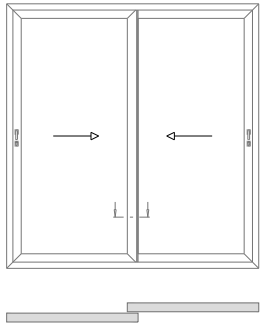

Reinforced
interlock
Section

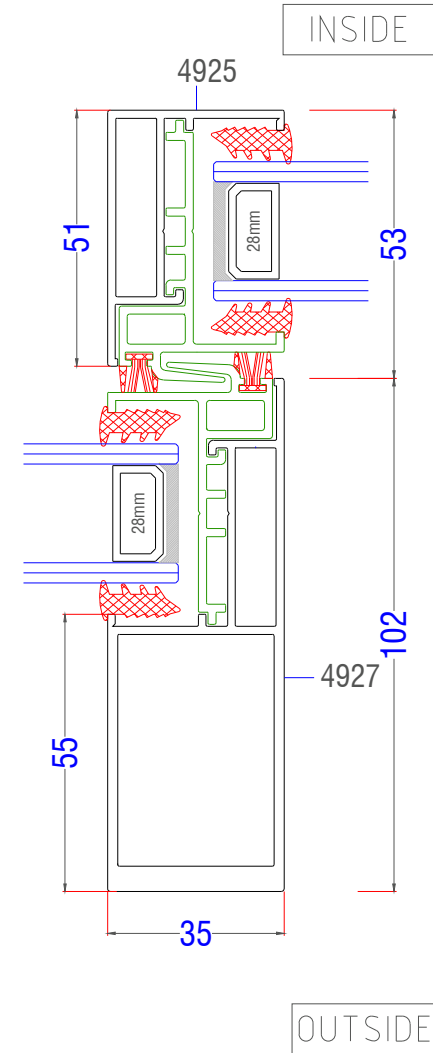
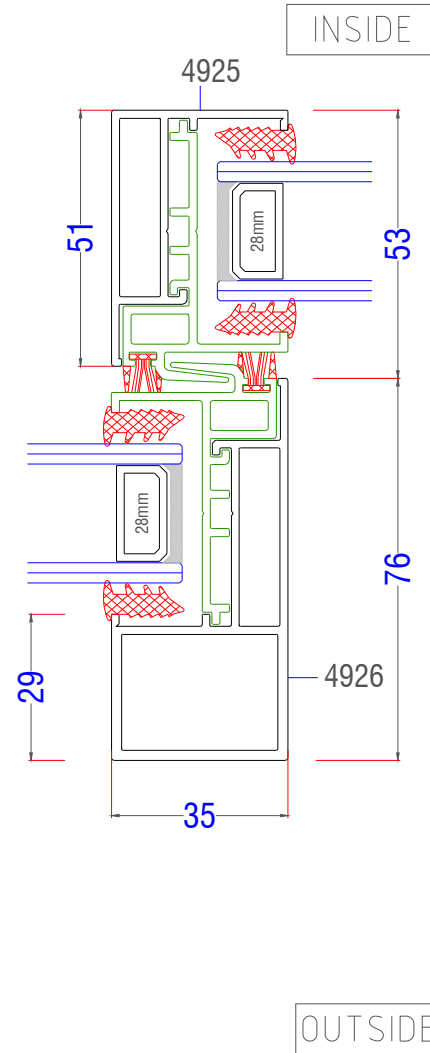
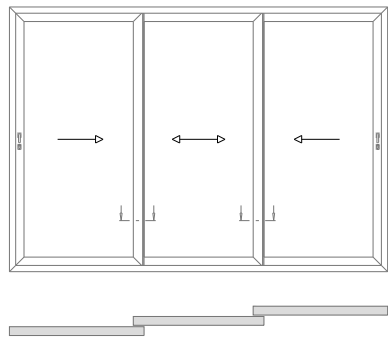

EdgeGLIDE+ - Typical Sections

Meeting Profile

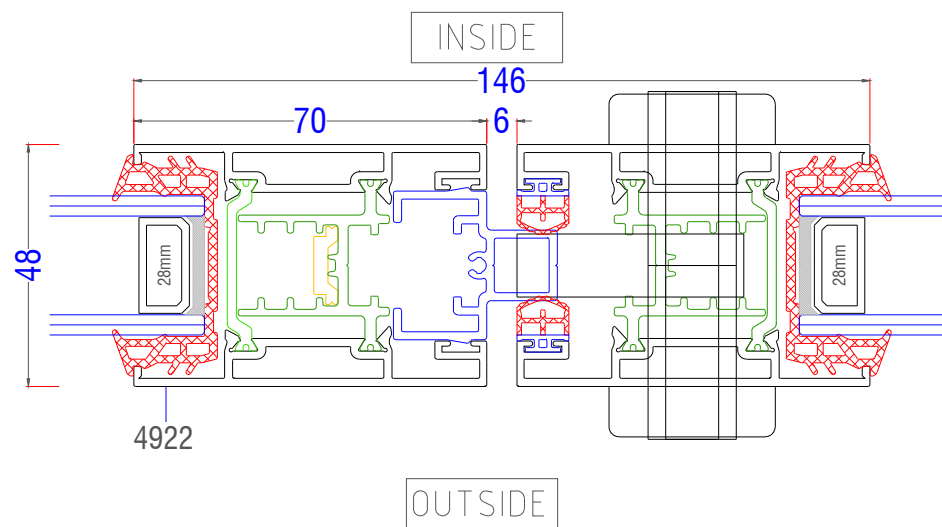
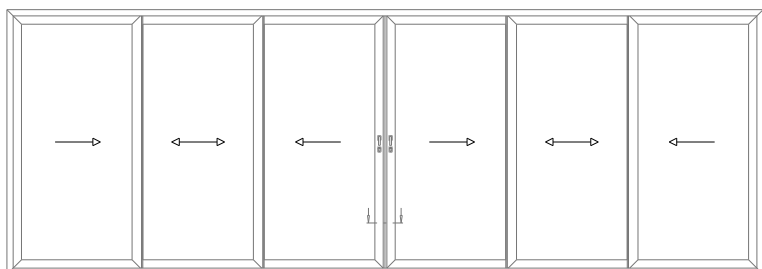
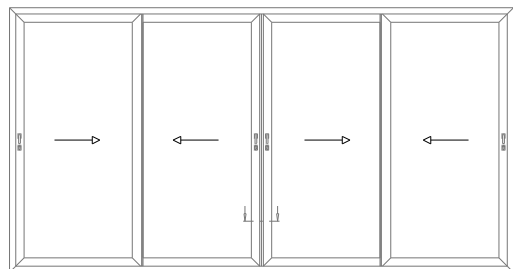

EdgeGLIDE+ - Typical Sections

Duo Frame - Cill Options

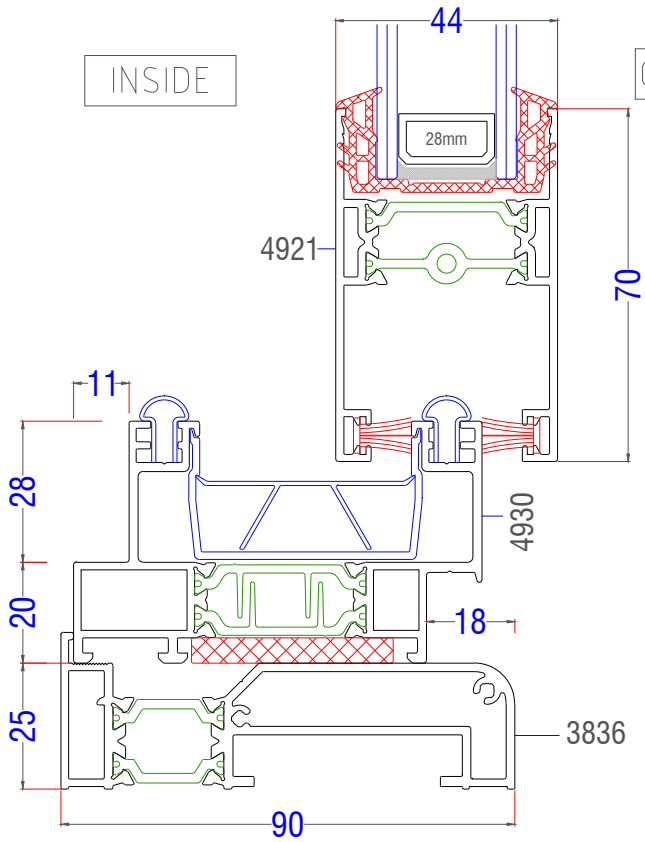
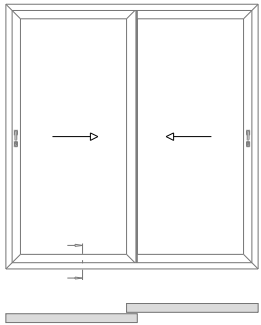

95mm stub Cill

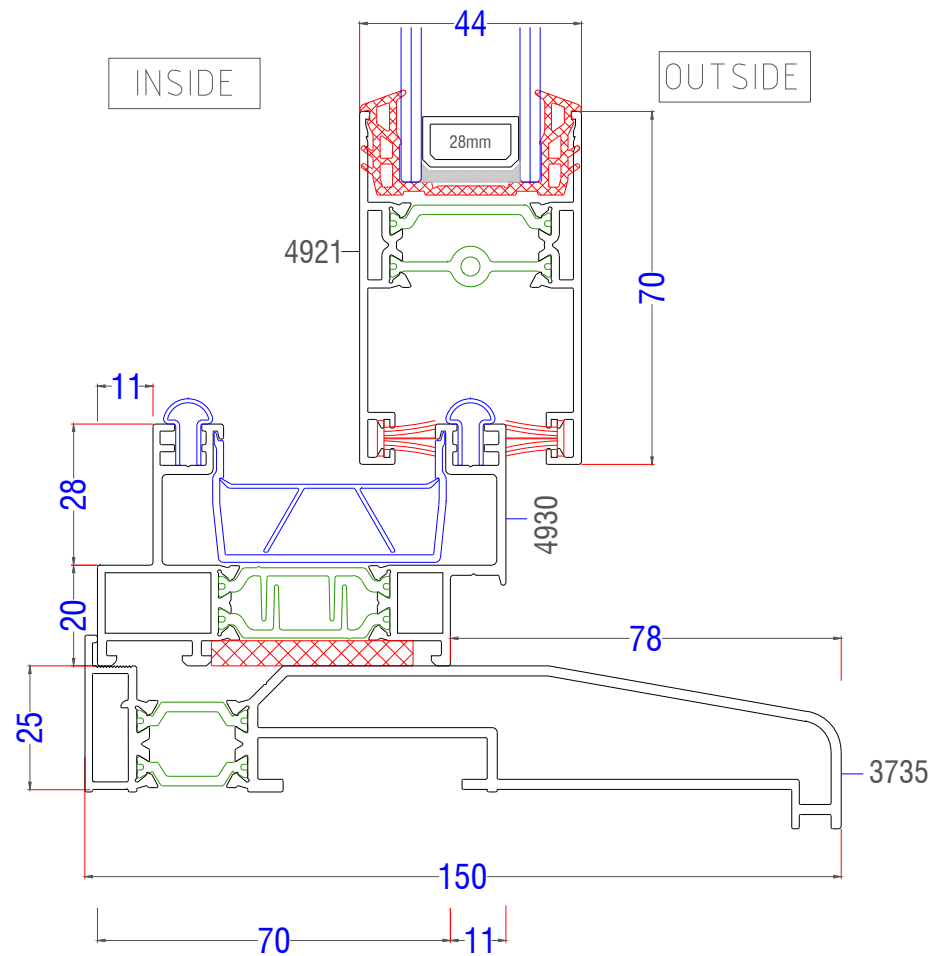

150mm Cill

EdgeGLIDE+ - Typical Sections

Duo Frame - Cill Options

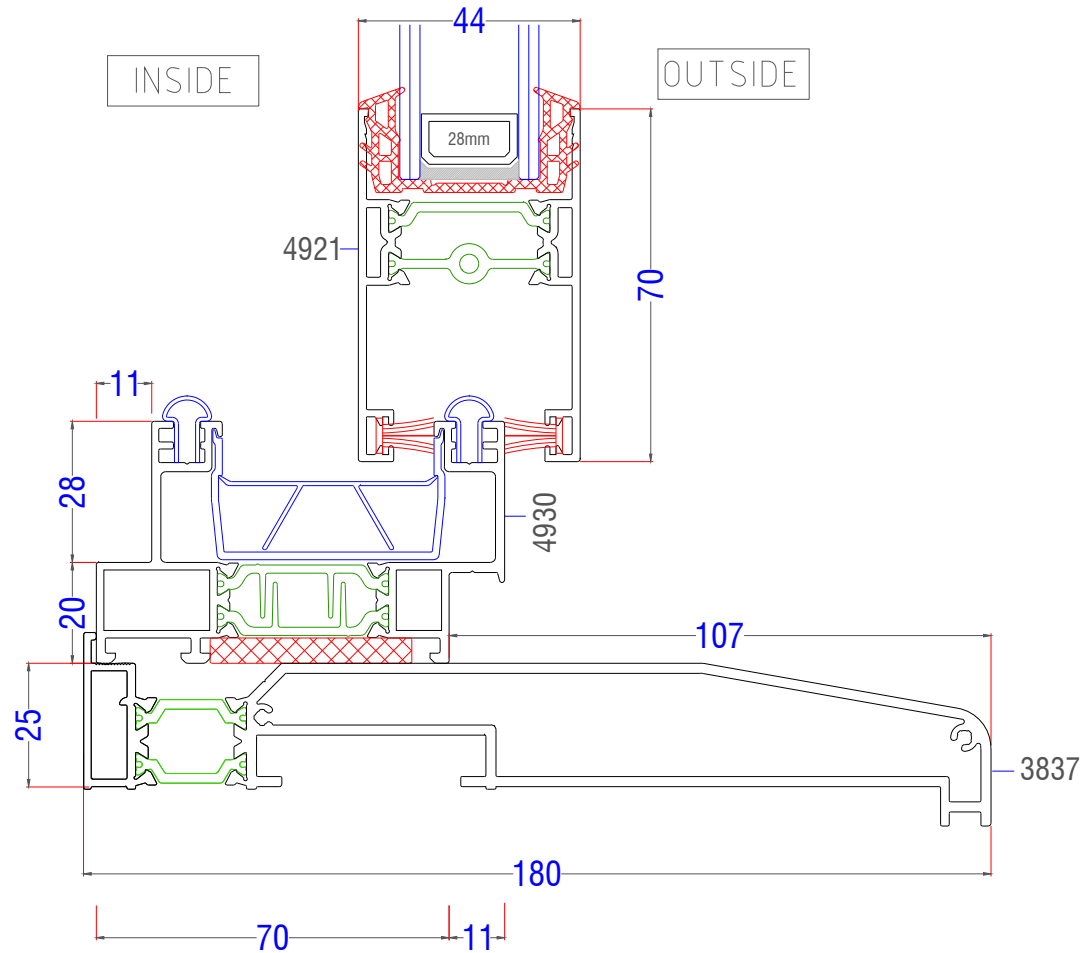
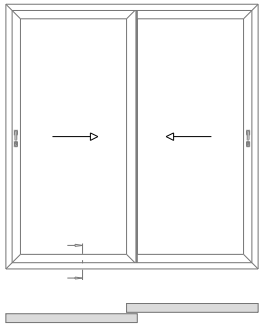

180mm Cill

EdgeGLIDE+ - Typical Sections

Duo Frame - Level FFL detail

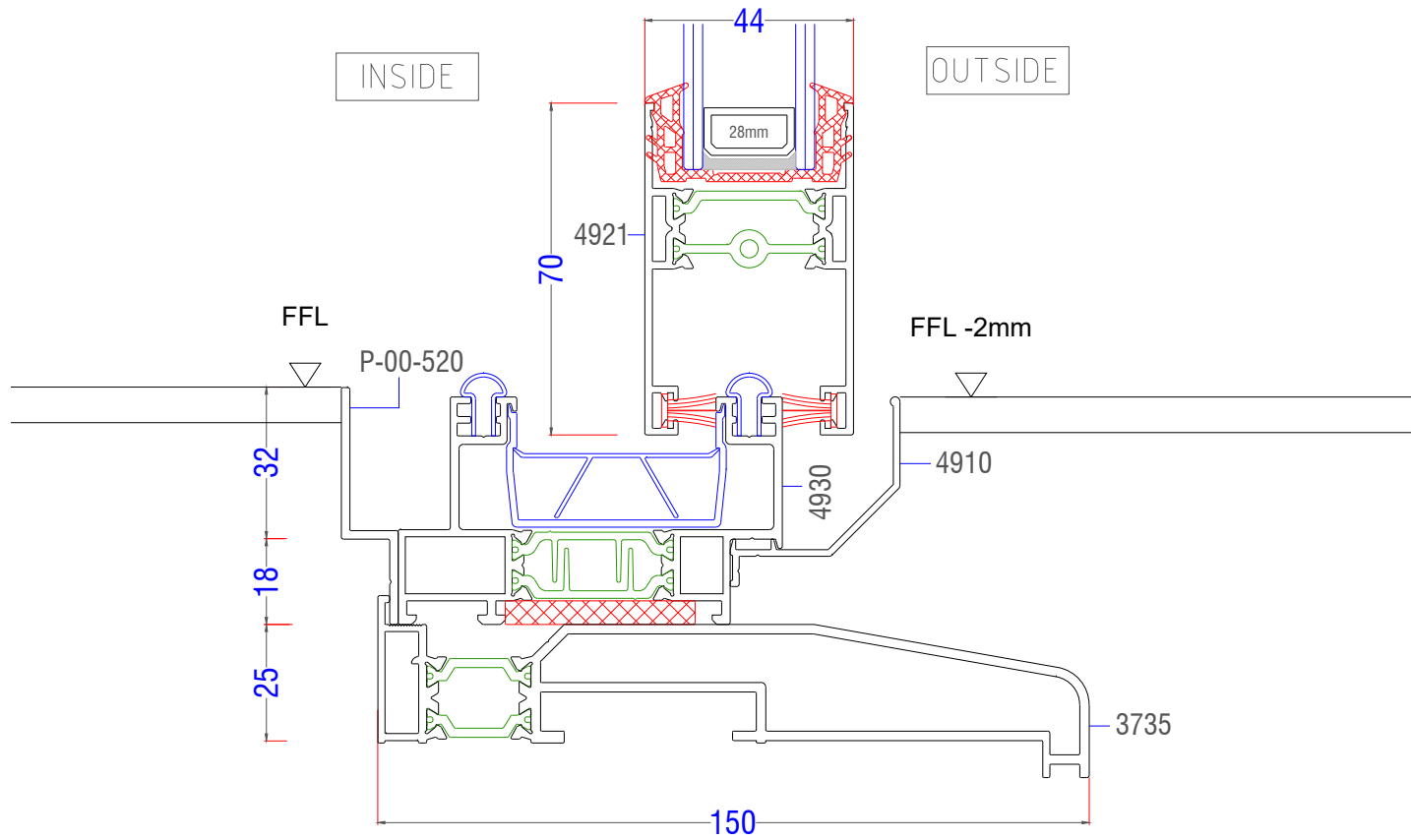
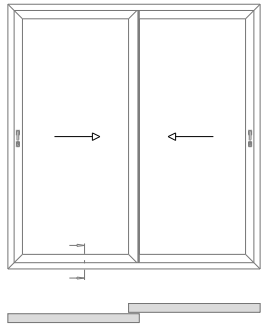

EdgeGLIDE+ - Typical Sections

Tri Frame - Cill Options

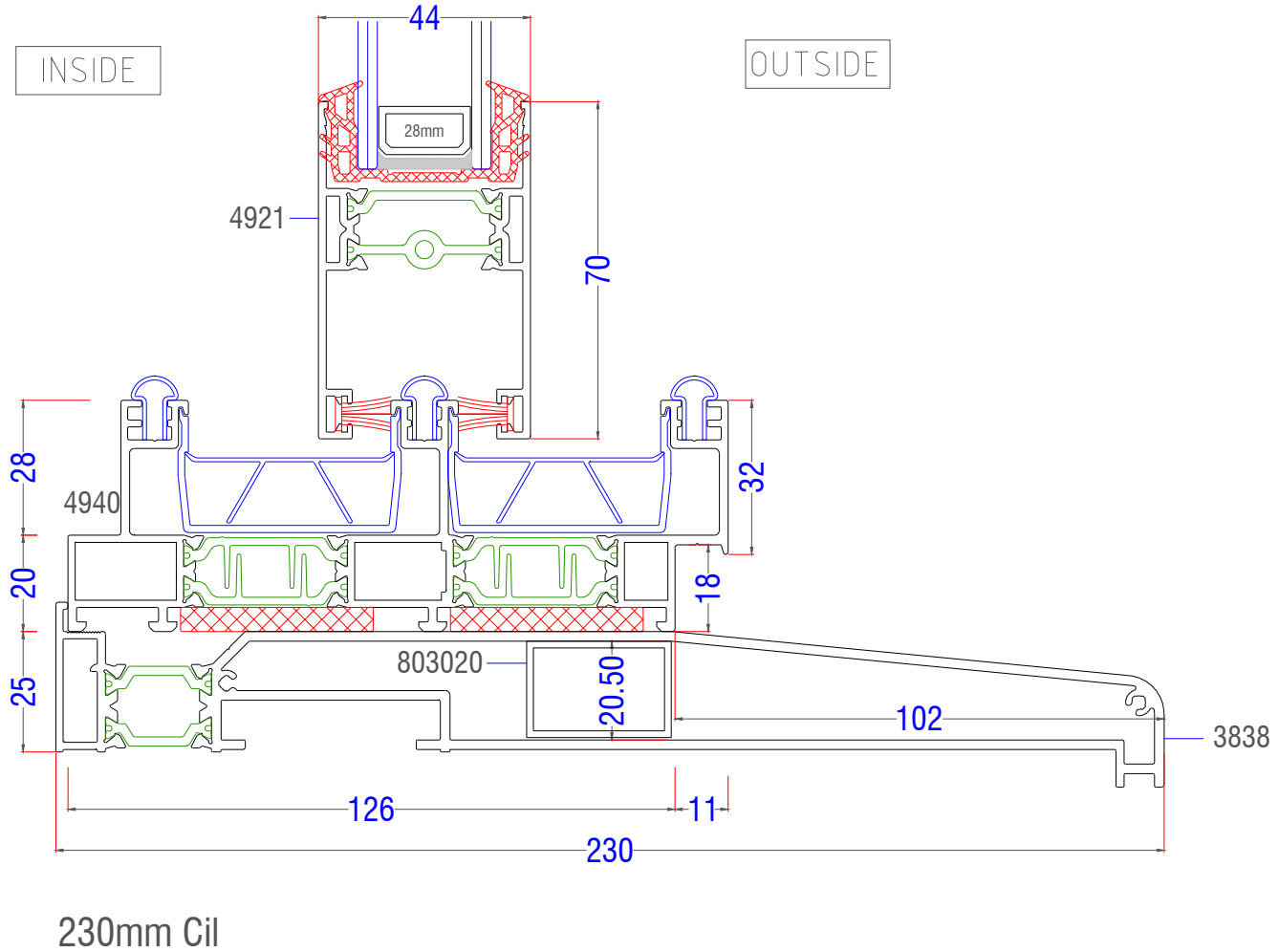
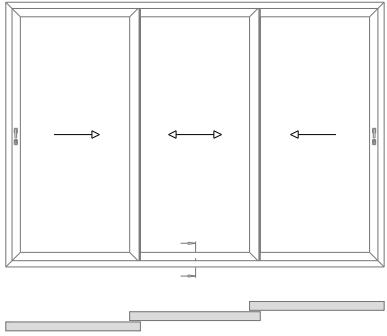

EdgeGLIDE+ - Typical Sections

Tri Frame - Level FFI detail

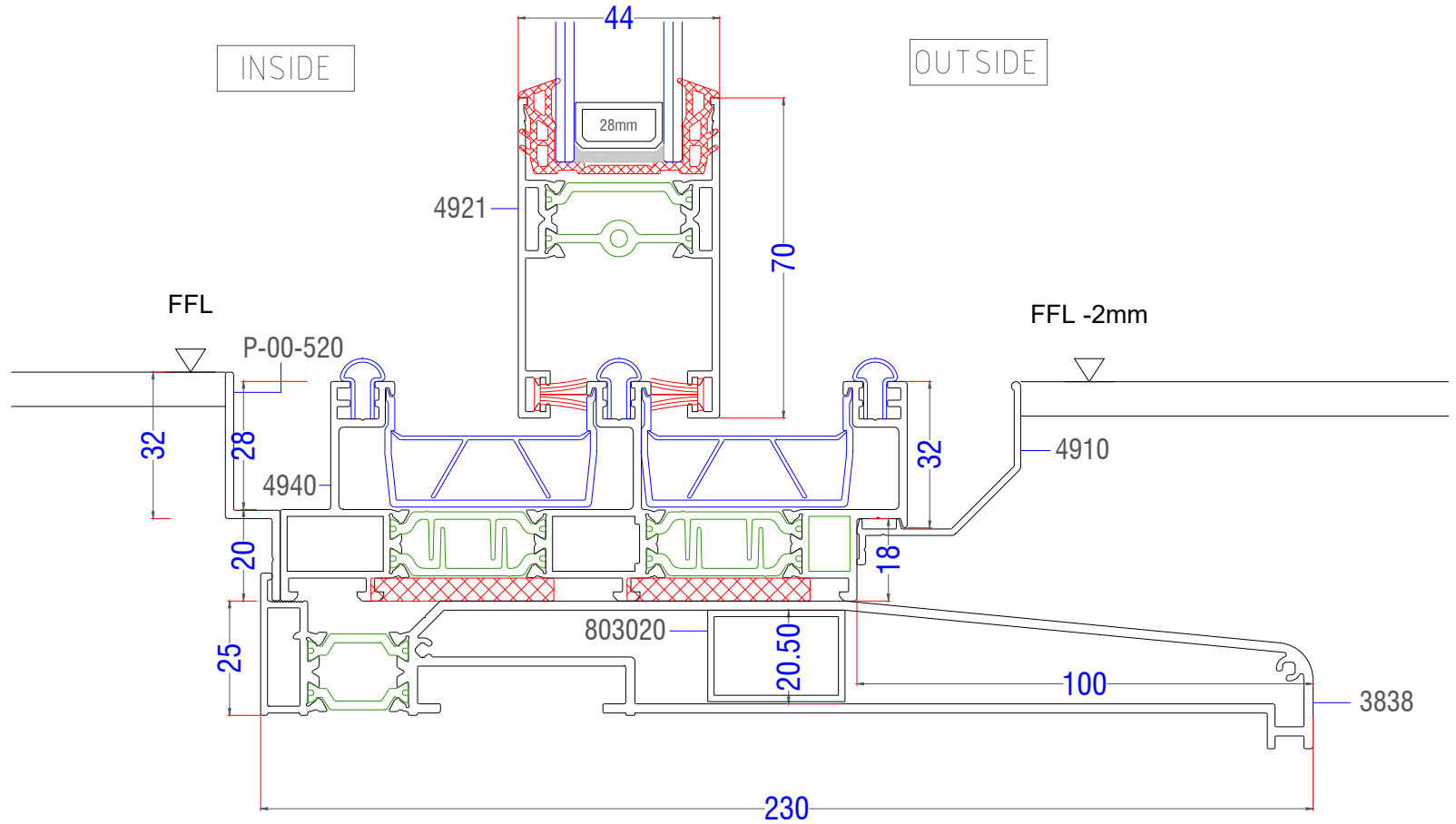
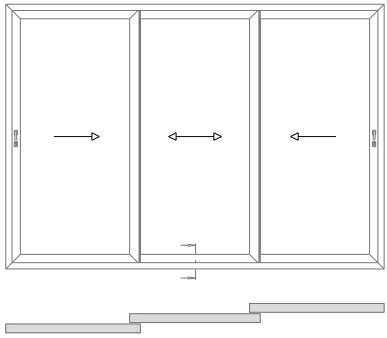

EdgeGLIDE+ - Typical Sections

Duo Frame - Add On with Trickle Vent

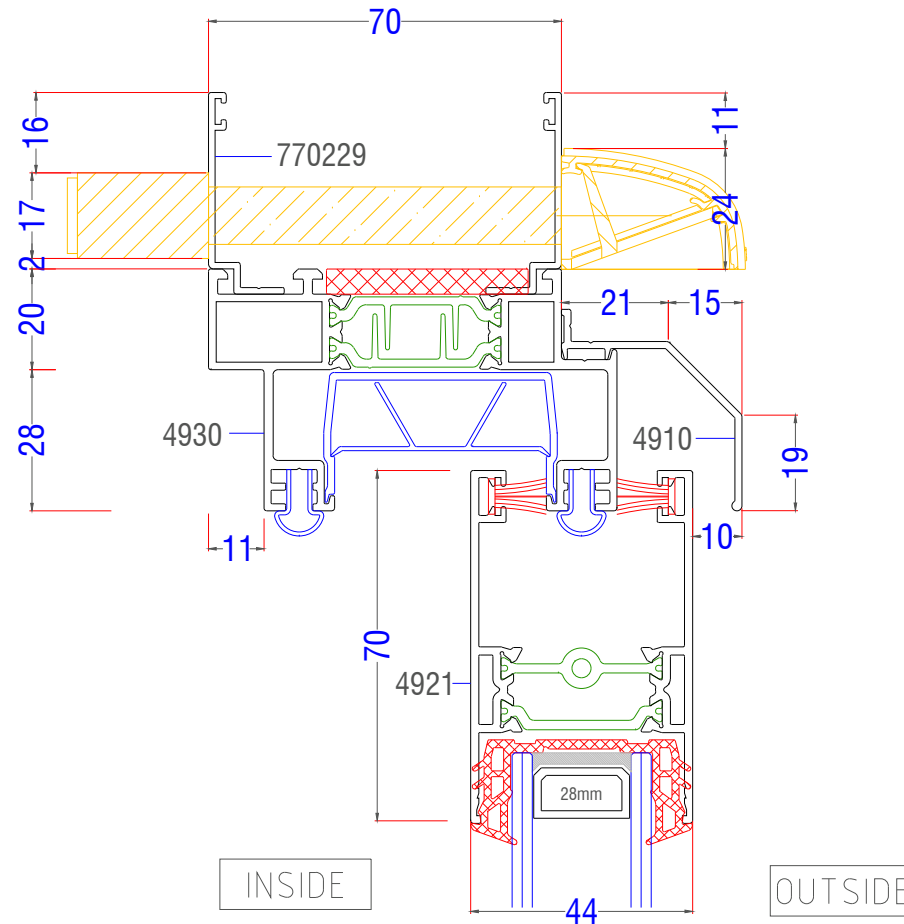
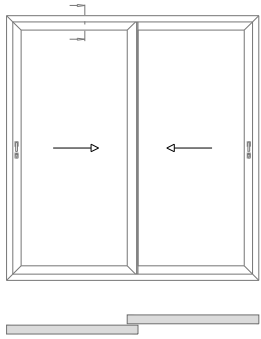

EdgeGLIDE+ - Typical Sections

Tri Frame - Add On with Trickle Vent

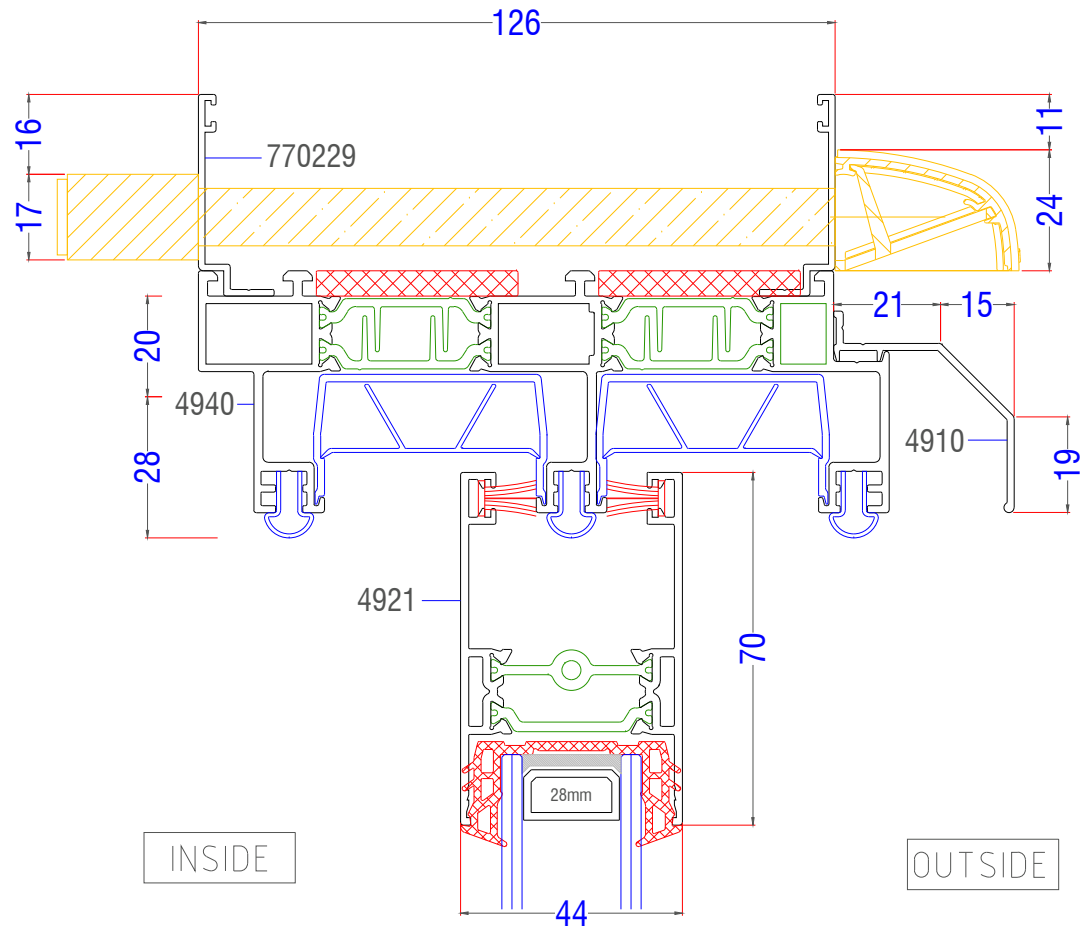
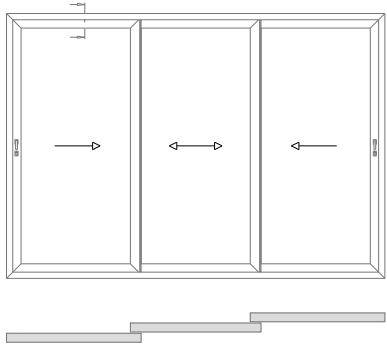



Class 6 Glazing Federation Member

Official Police Security Initiative

Arkay Windows is a specialist large-scale fabricator with over 30 years experience based in Watford, North West London.

Through growth built on putting our customers first, we have risen to supply some of the country's biggest retail companies, contractors and commercial installers.

 **Arkay Windows**

Watford: 01923 803923
London: 020 8889 6821

sales@arkaywindows.com
www.arkaywindows.com

