



Arkay Windows

TECHNICAL DOCUMENTS

ALUK 58 BW HI

ALUK 58 BW HI



58BW HI Casement Window

HIGH PERFORMANCE SOLUTION

An effective high performance solution - Offering clean lines and advanced functionality for both new build and residential replacement applications. This window system is available in a range of configurations from Casement, tilt-before-turn and top-swing-reverse.

DESIGN FEATURES

- Certified under the Secured By Design scheme
- Tested to PAS 24
- Green Guide Rated A
 - Integrated deep head profiles for ease of trickle ventilation
- Unique polamide thermal break design to improve thermal performance

OPTIONS

- 58mm frame depth
- Project in or project out options
 - Internally or externally glazed to accommodate low or high rise projects
- Glazing 24mm - 40mm
- Available in a range of single or dual colours, and anodised finishes
- Available for Lifetime Homes (LFT)

Size Limits Max Weights

	Casement	TBT	TSR
Top Hung	180kg		
Tilt Before Turn	100kg -		
Side Hung	55kg	100kg	
Bottom Hung	60kg		
Top Swing	50kg		
Side Swing		45kg	
Fixed Light	250kg	250kg	

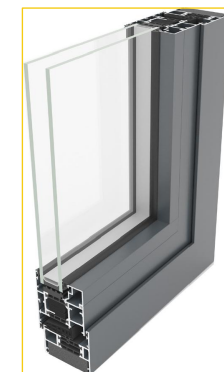

	CASEMENT	TBT	TSR
FRAME DEPTH	58mm	58mm	58mm
DUAL COLOUR OPTION	Yes	Yes	Yes
MULTI-POINT LOCKING	Yes	Yes	Yes
GLAZING OPTIONS	Internal & External Bead	Internal & External Bead	Internal Bead
GLAZING THICKNESS	24mm - 40mm	24mm - 40mm	24mm - 28mm
SIGHTLINE FRAME TO VENT	75mm	86mm	103mm
SIGHTLINE FRAME TO MULLION	89mm	100mm	161mm
SIGHTLINE FIXED LIGHT	43mm	43mm	-

PERFORMANCE	CASEMENT	TBT	TSR
U-VALUE DOUBLE GLAZING	1.4 W/m²K	1.5 W/m²K	1.7 W/m²K
U-VALUE TRIPLE GLAZING	1.2 W/m²K	1.3 W/m²K	
WINDOW ENERGY RATING	B-C	B-C	
GREEN GUIDE RATING	A Rated	A Rated	A Rated
ACOUSTIC PERFORMANCE	Rw (C;Ctr) 42 (-1;-5) db	Rw (C;Ctr) 44 (-1;-4) db	-
AIR TIGHTNESS	Class 4	Class 4	Class 4
WATER TIGHTNESS	Class 9A	Class 9A	Class 9A
WIND LOAD	Class E2400	Class E2400	Class A5
SECURITY	PAS 24	PAS 24	PAS 24
3RD PART CERTIFICATION	Q-Mark	Q-Mark	Q-Mark
SECURED BY DESIGN	Yes	Yes	Yes

ALUK 58BW HI - Contents

- 1.0 Typical Elevations
- 2.0 Standard Profiles
- 3.0 Typical Sections
 - 3.1 Fixed Jamb
 - 3.2 Open Out Jamb
 - 3.3 Fixed Head
 - 3.4 Open Out Head
 - 3.5 Head Detail with Trickle Vent
 - 3.6 Base Cill Details:
 - 3.6a 95mm Stub Cill
 - 3.6b 150mm Drop Nose Cill
 - 3.6c 190mm Drop Nose Cill
 - 3.7 Coupling Bars:
 - 3.7a Concealed Coupler
 - 3.7b 25/15 Coupler
 - 3.7c 36/26 Coupler
 - 3.8 Fixed - Open Mullion
 - 3.9 Open - Open Mullion
 - 3.10 Fixed - Fixed Transom
 - 3.11 Fixed - Open Transom
 - 3.12 Open - Open Transom
 - 3.13 Bay Window Baypole / 90° Corner Post
 - 3.14 Frame Extender

58BW HI - Elevation

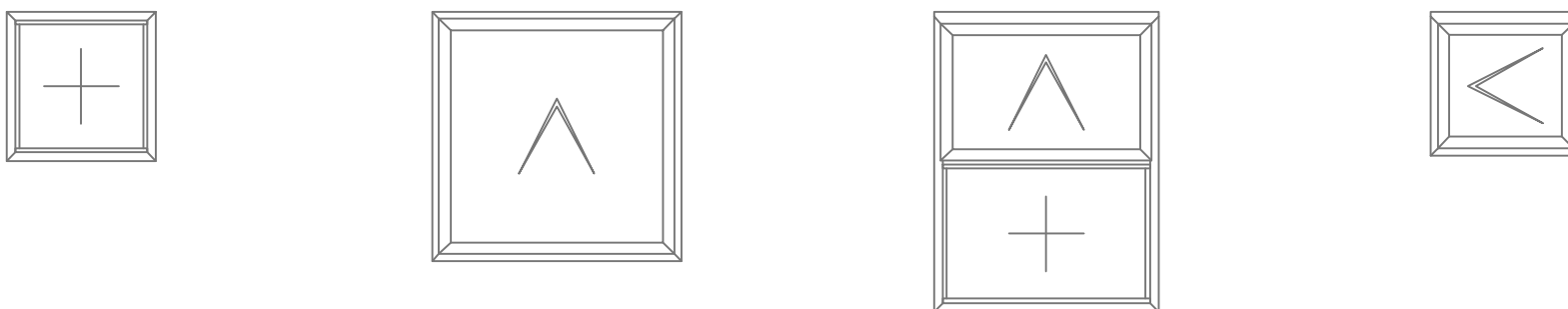
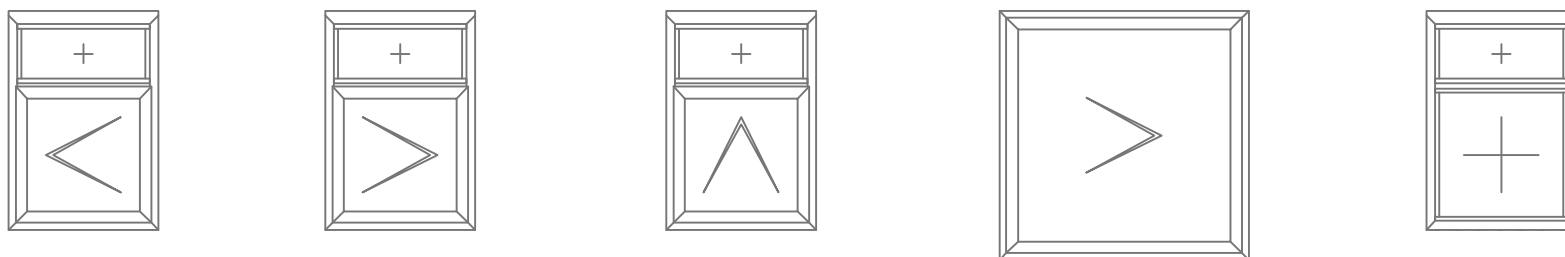
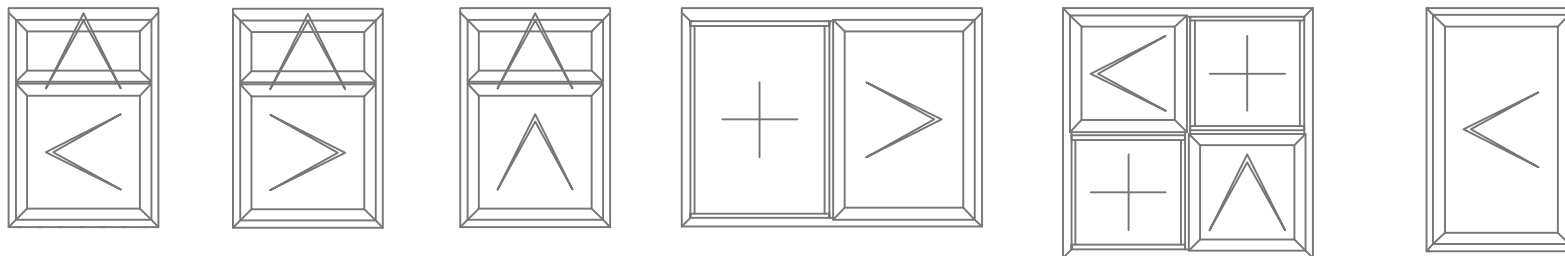

AL UK 58BW HI- Standard Profiles

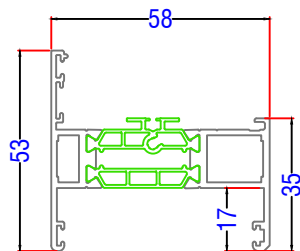

U44009 - Outer Frame

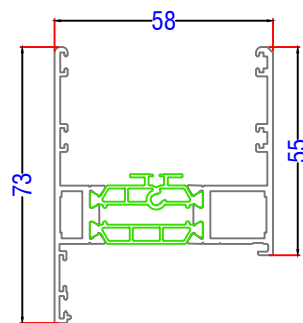

U44012- Deep Outer Frame

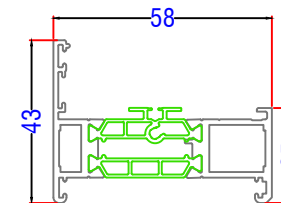

U44008 - Outer Frame

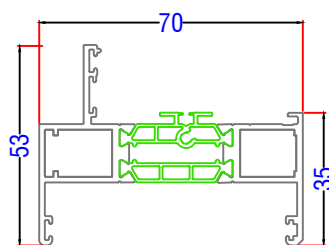

U44013- Outer Frame

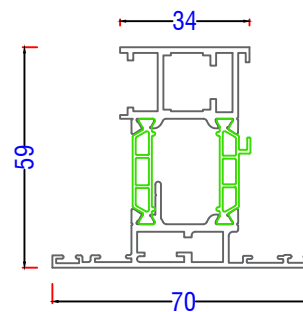

U44105 - Vent

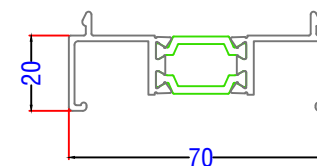

AL UK AW724 - Frame Extender

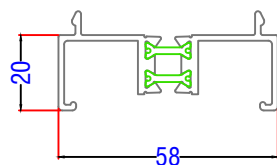

AL UK AW725 - Frame Extender

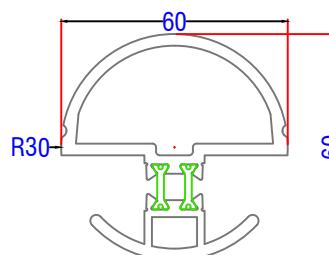

AL UK AW712 - Baypole

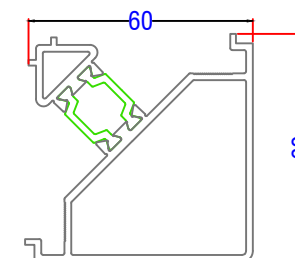

AL UK AW721 - Baypole

AL UK 58BW HI- Standard Profiles

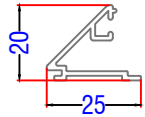

AL UK AW513 - Chamfered Glazing Bead

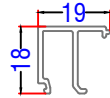

AL UK AW683 - Square Glazing Bead

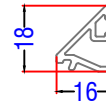

AL UK AW682 - Chamfered Glazing Bead

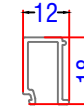

AL UK AW663 - Flat Glazing Bead

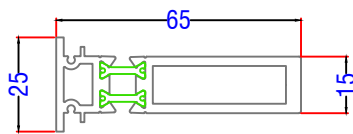

AL UK AW703 - Coupling Bar

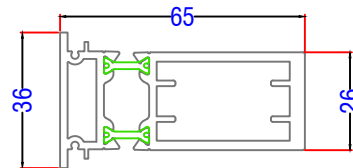

AL UK AW706 - Coupling Bar

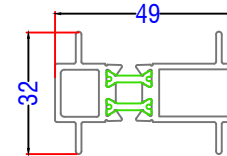

AL UK AW710 - Coupling Bar

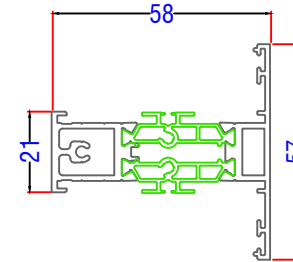

U44045 - Mullion/Transom

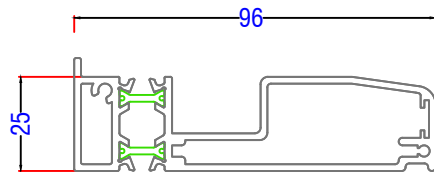

AL UK AW570 - 95mm Stub Cill

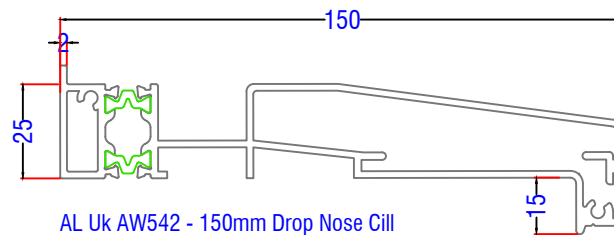

AL UK AW542 - 150mm Drop Nose Cill

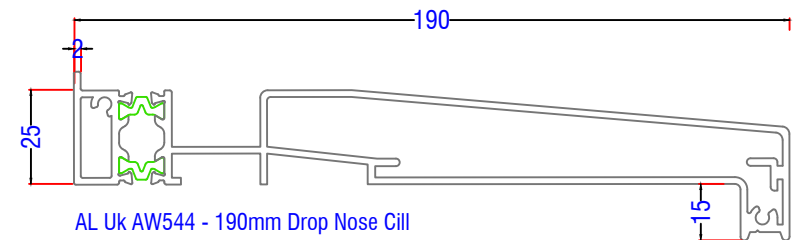

AL UK AW544 - 190mm Drop Nose Cill

AL UK 58BWHI - Fixed jamb

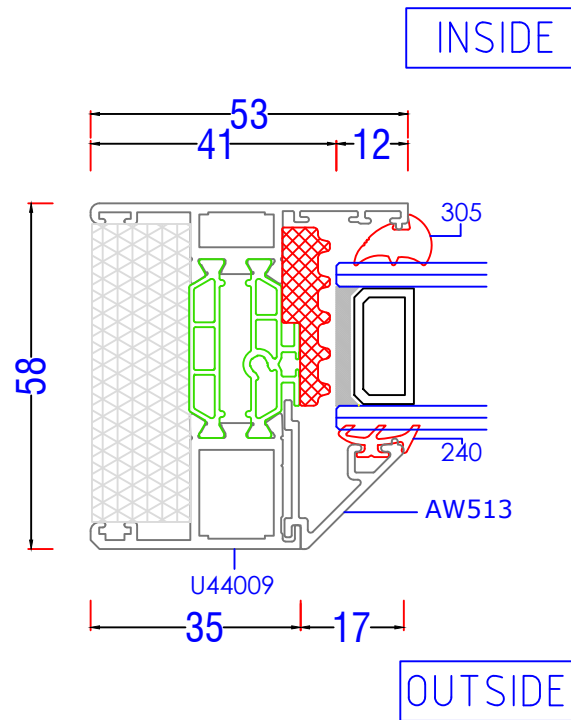
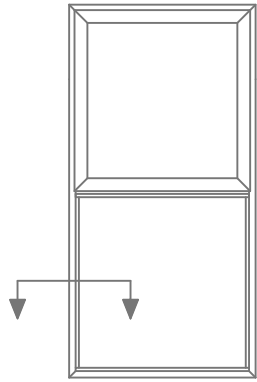

AL UK 58BW HI - Fixed head

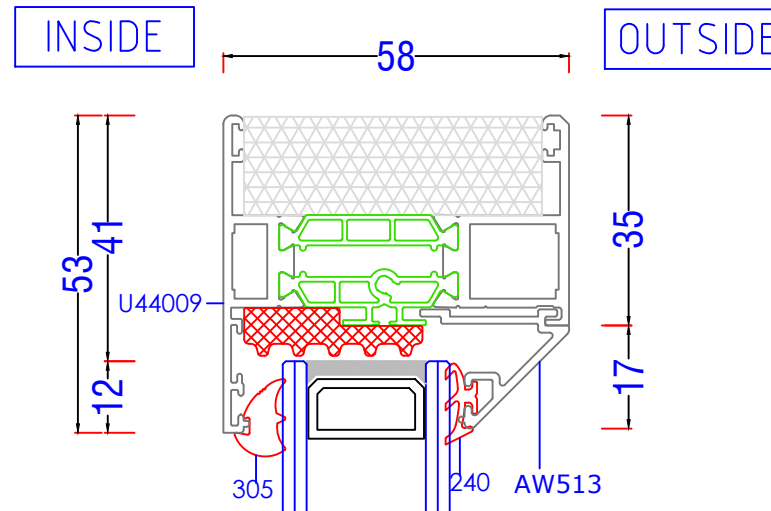
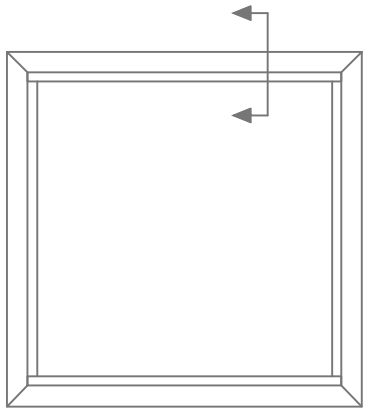

AL UK 58BW HI- Open Out Head

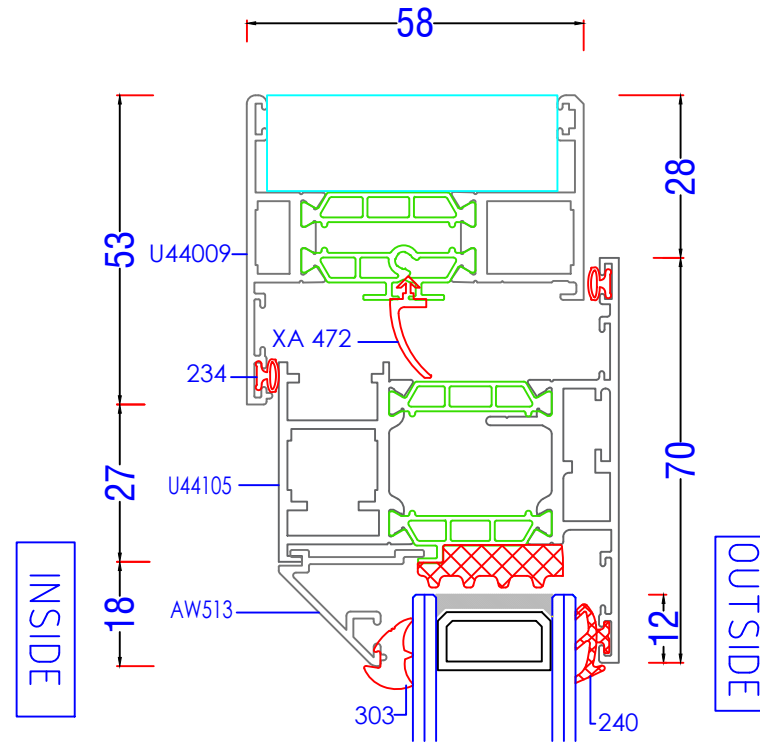
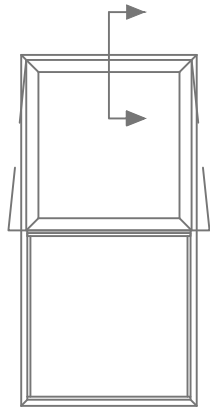

AL UK 58BW HI - Open Out TV Head

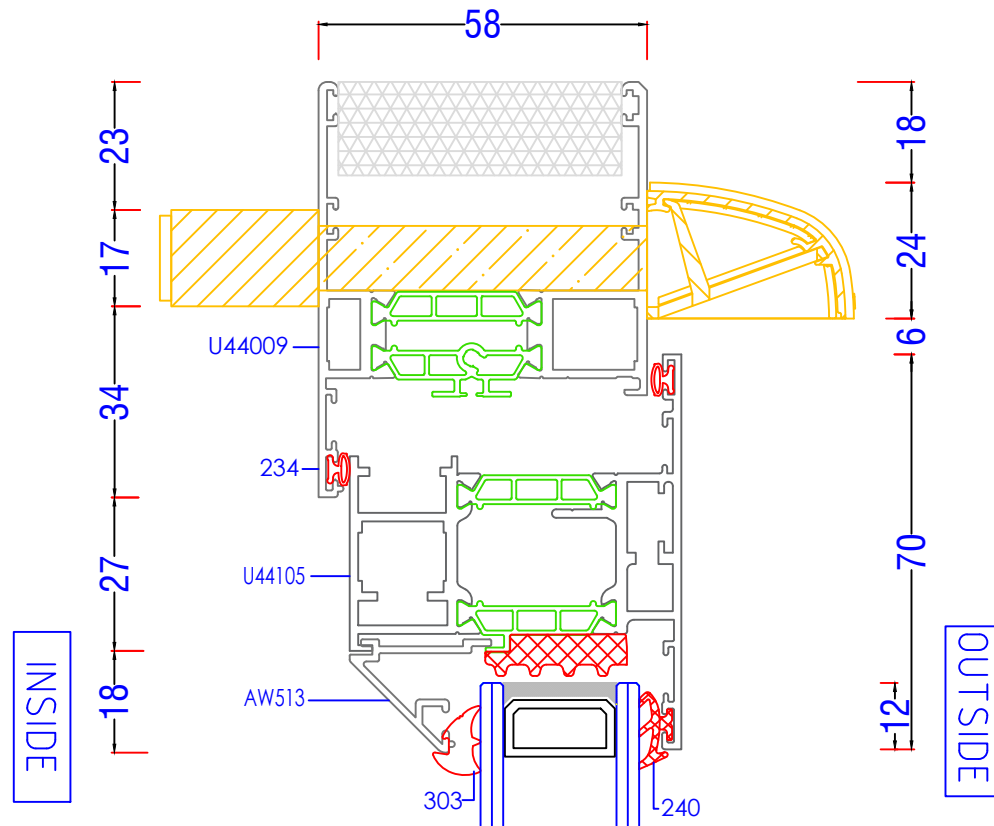
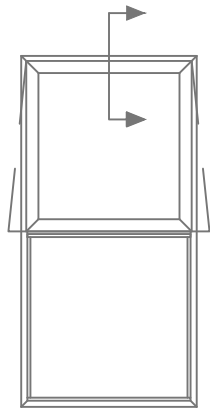

AL UK 58BW HI - 90mm Stub Cil

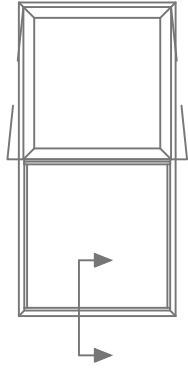

INSIDE

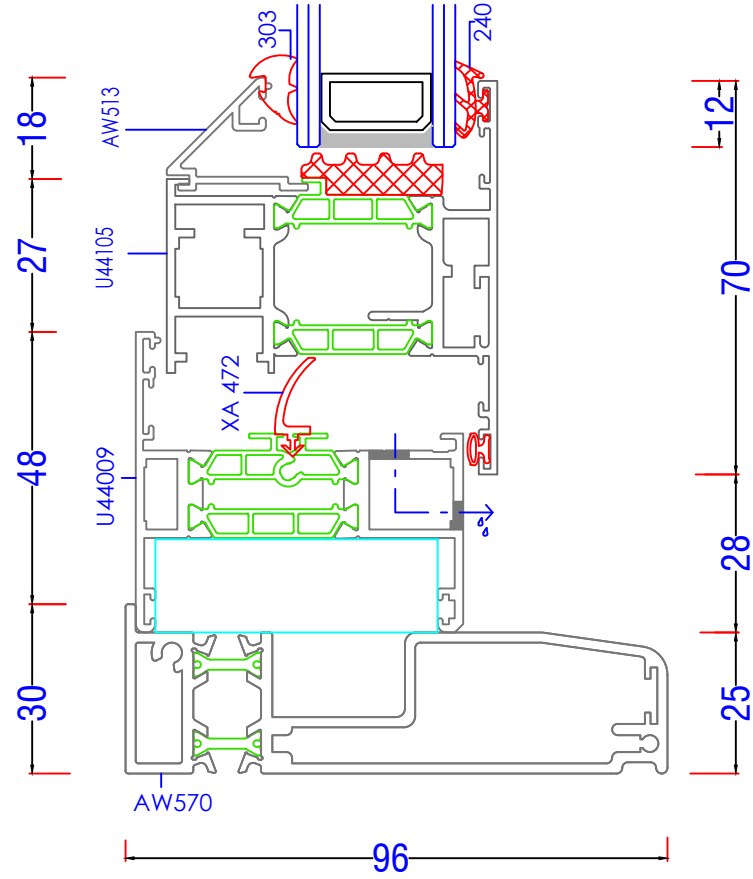

OUTSIDE

AL UK 58BW HI - 150mm Cil

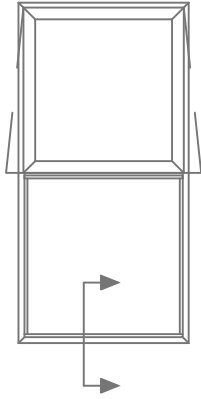

INSIDE

OUTSIDE

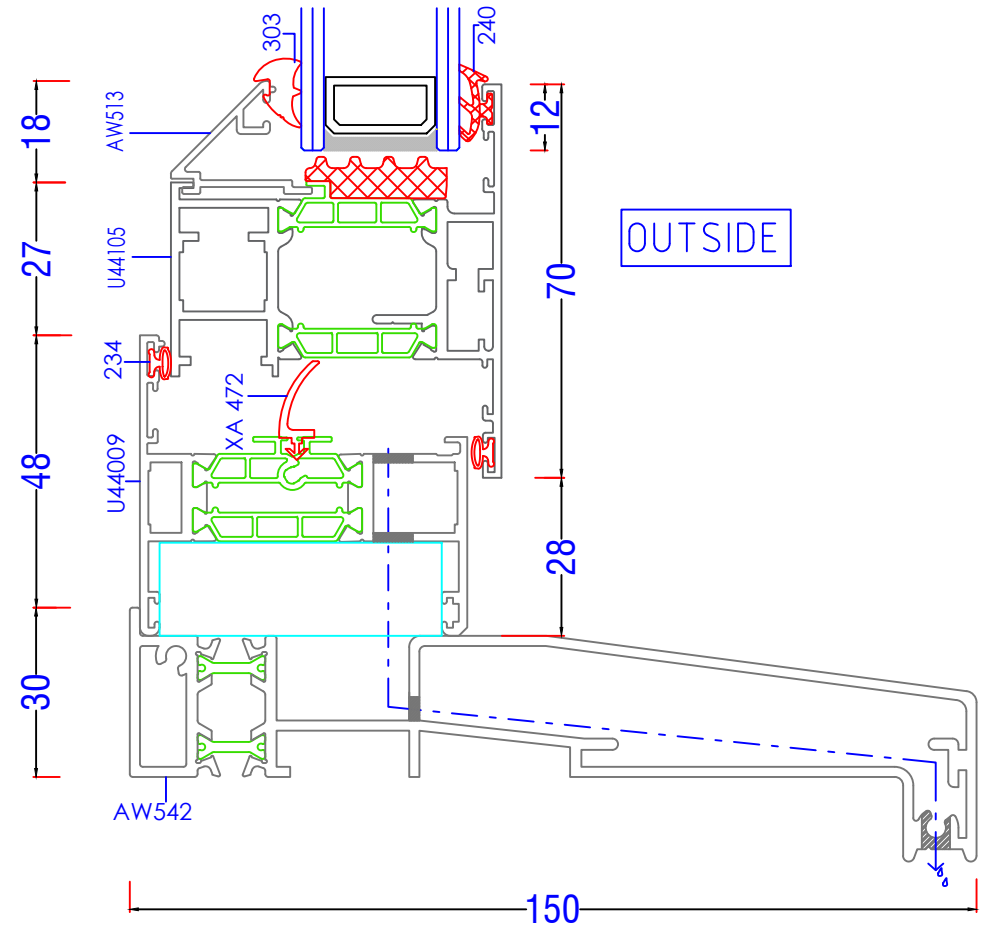

AL UK 58BW HI - 190mm Cil

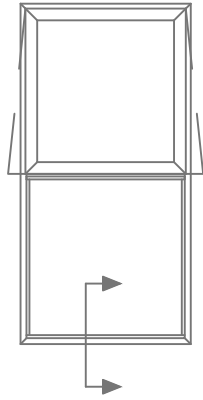

INSIDE

OUTSIDE

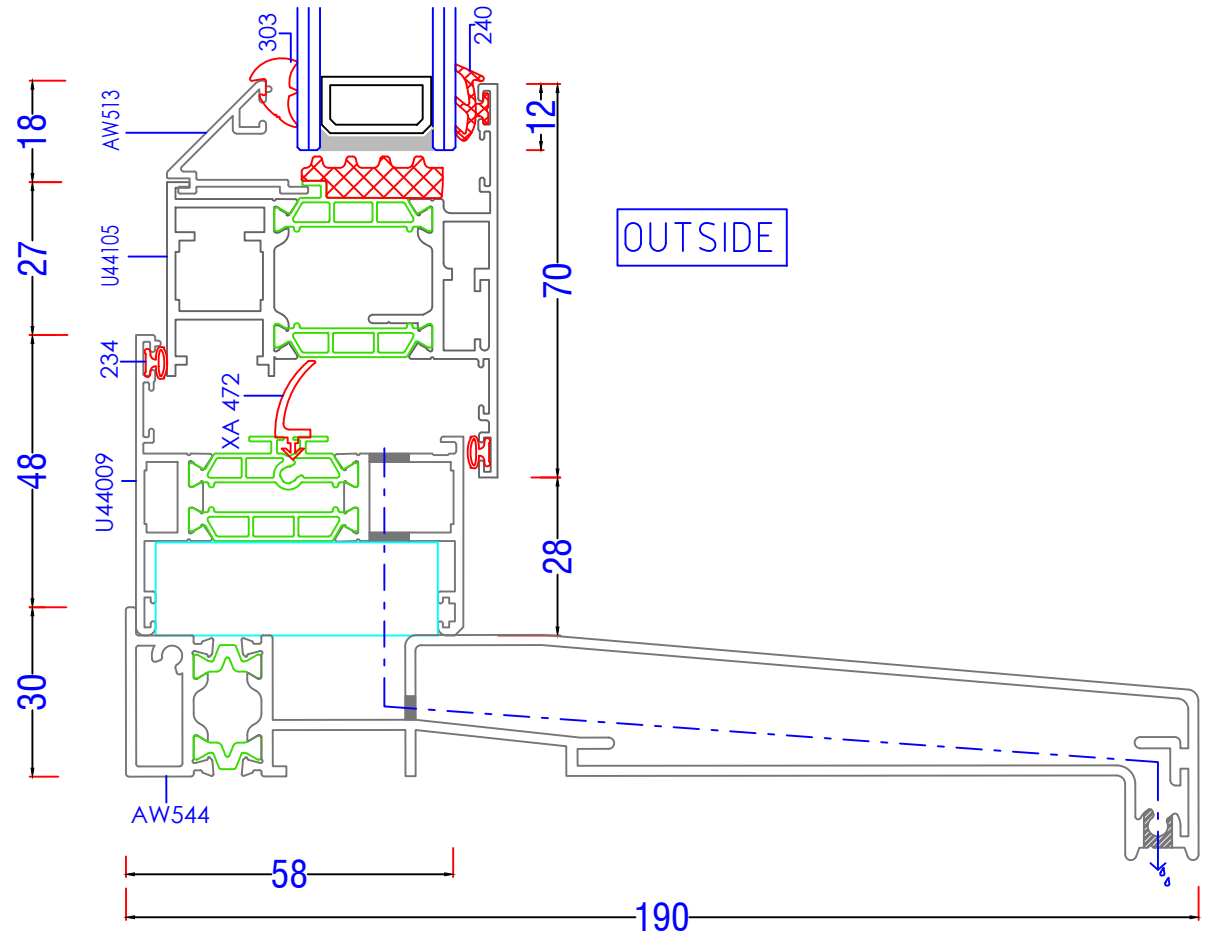

AL UK 58BW HI - Concealed Coupler

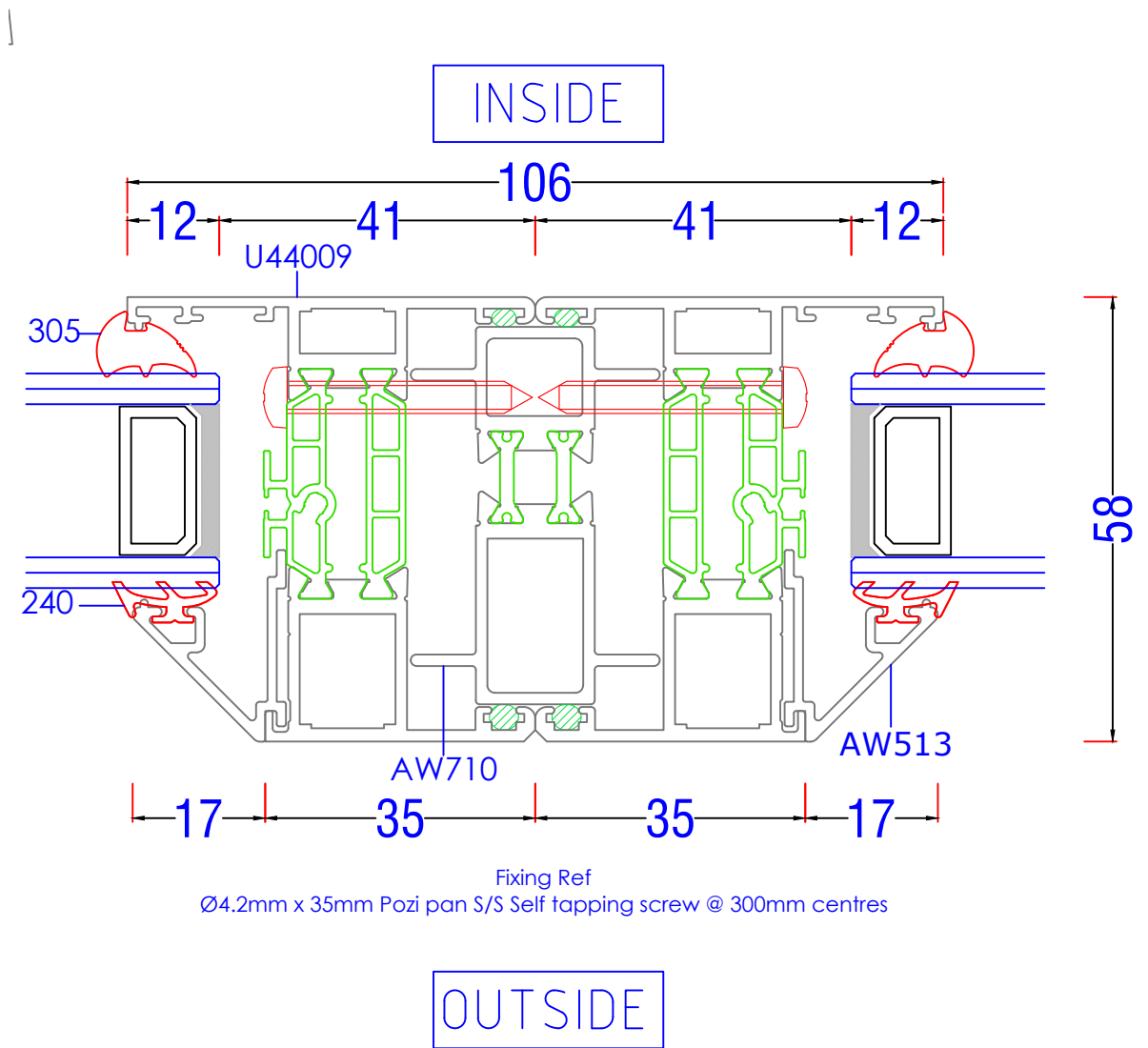
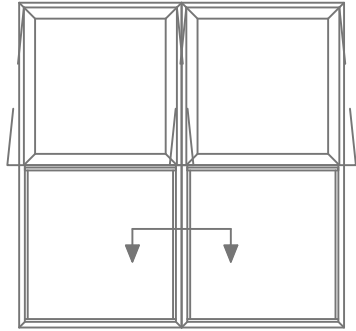

AL UK 58BW HI - 25/15 Coupler

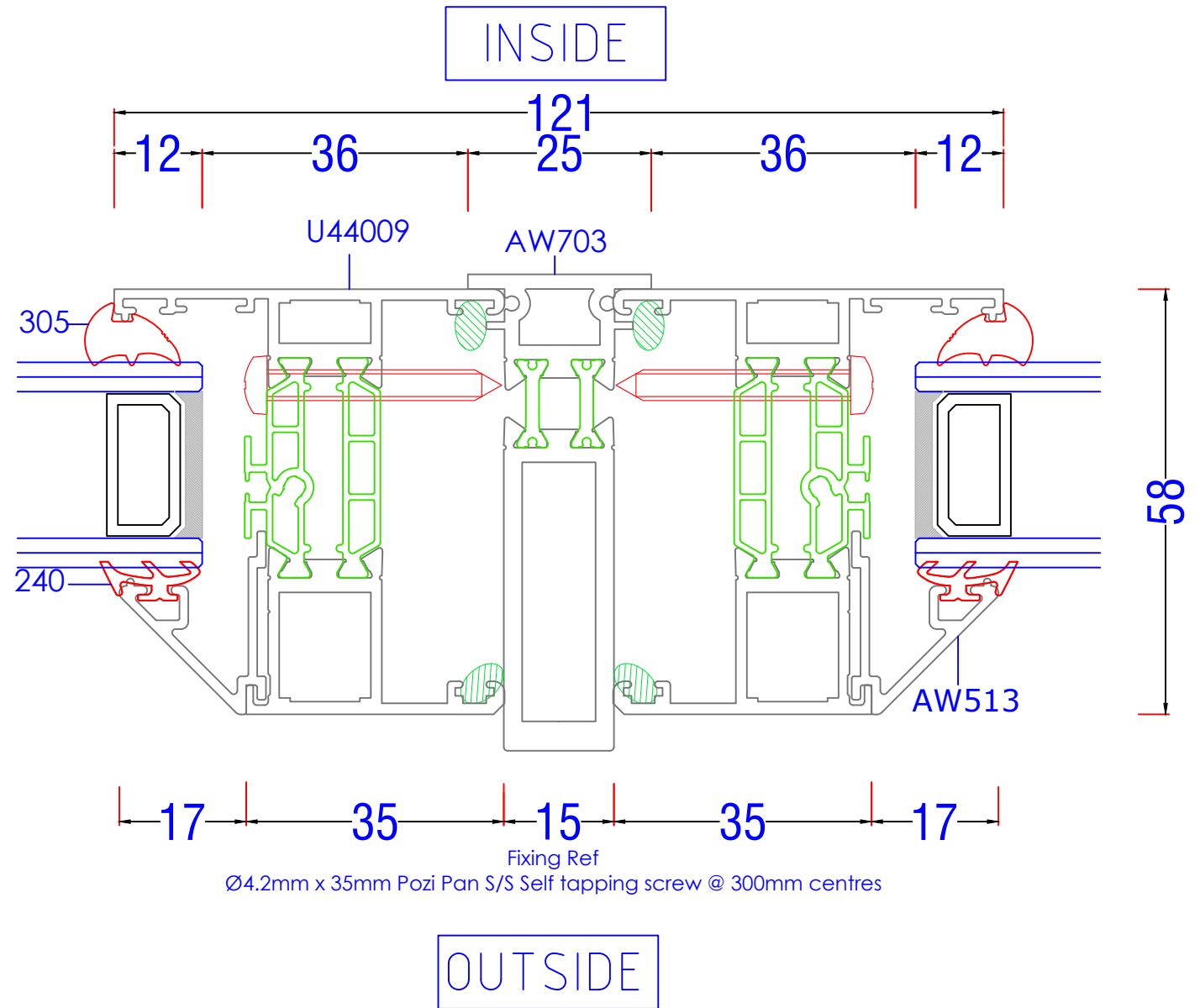
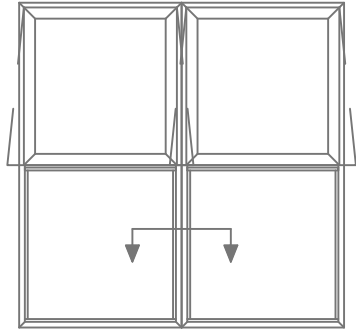

AL UK 58BW HI - 36/26 Coupler

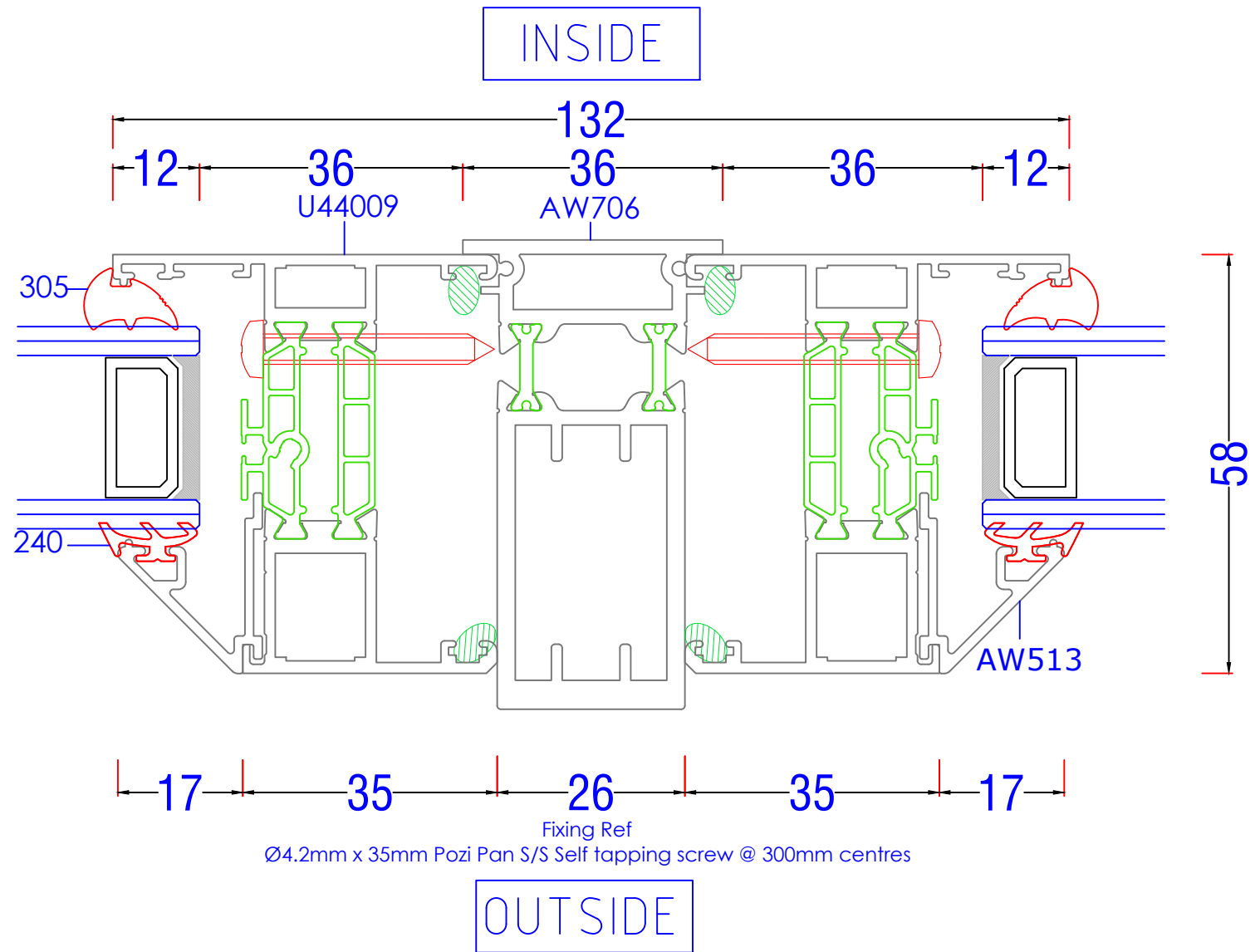
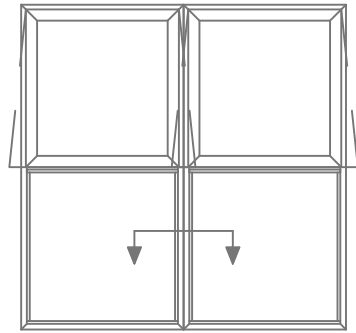

AL UK 58BW HI - Fixed to Opening Mullion

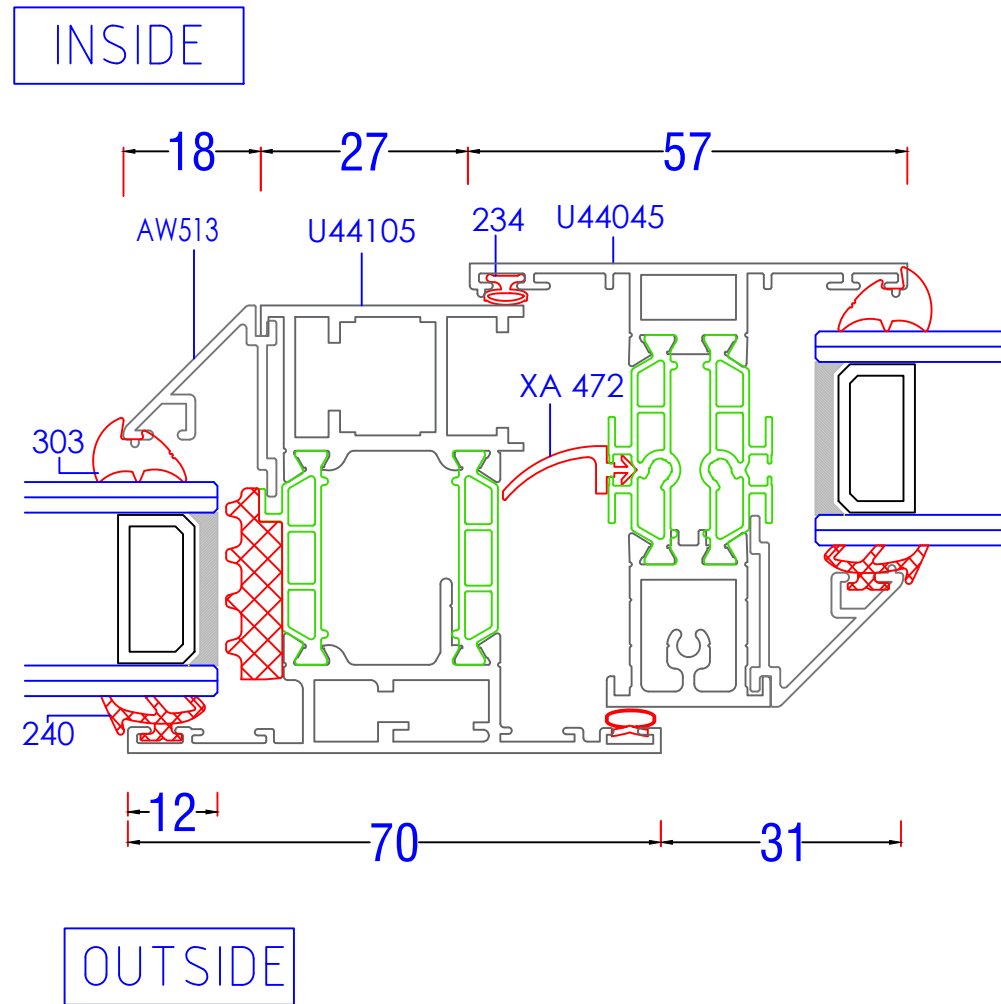
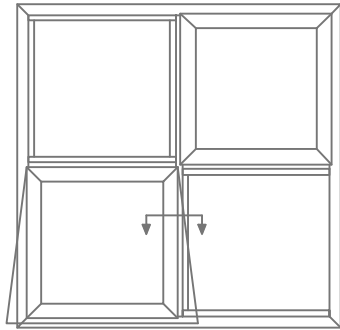

AL UK 58BW HI- Open to Open Mullion

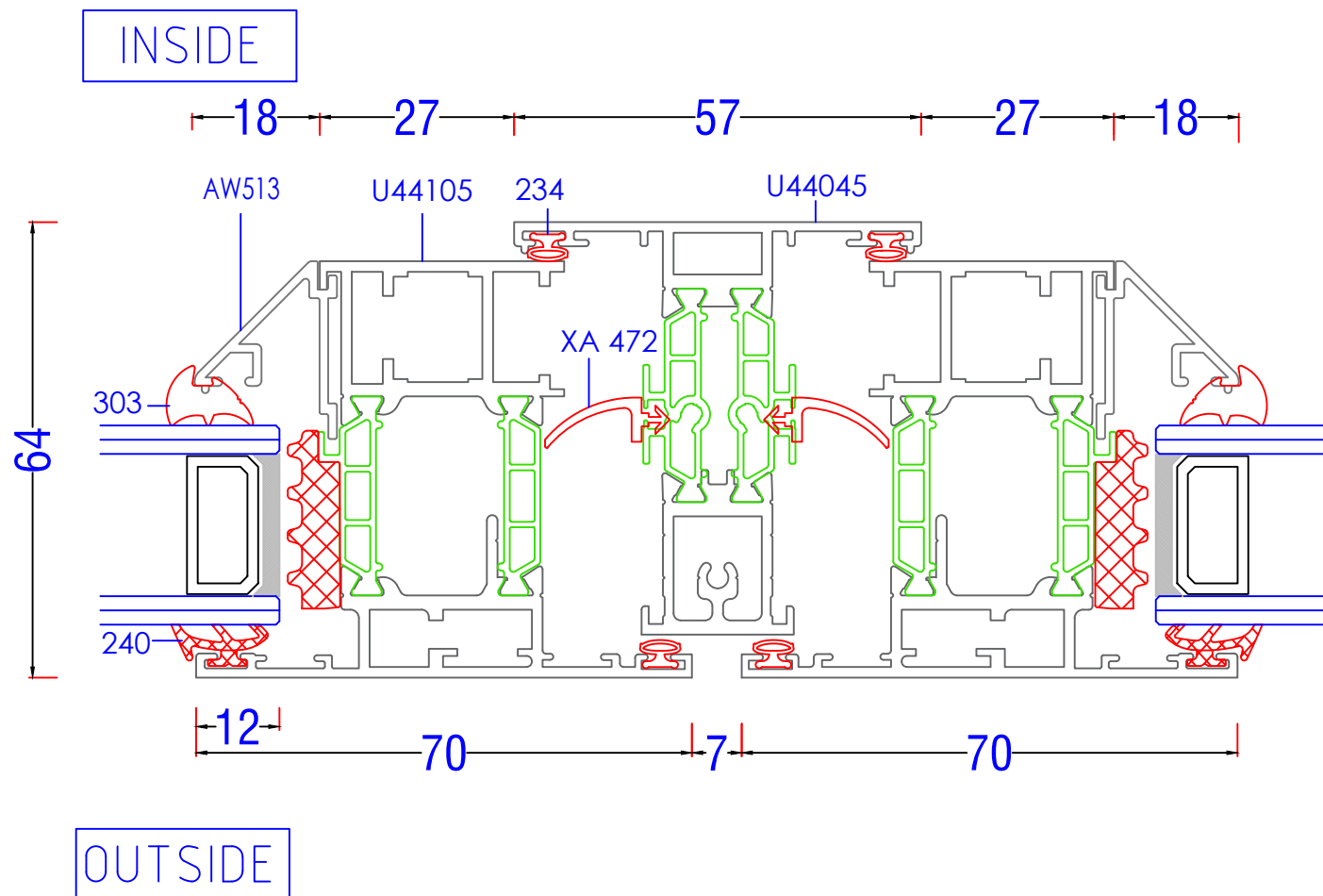
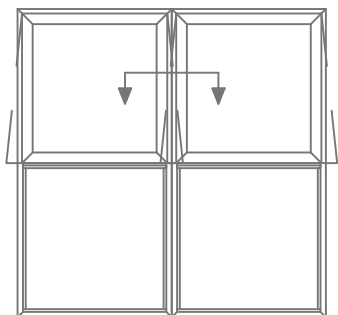

AL UK 58BW HI - Fixed to Fixed Transom

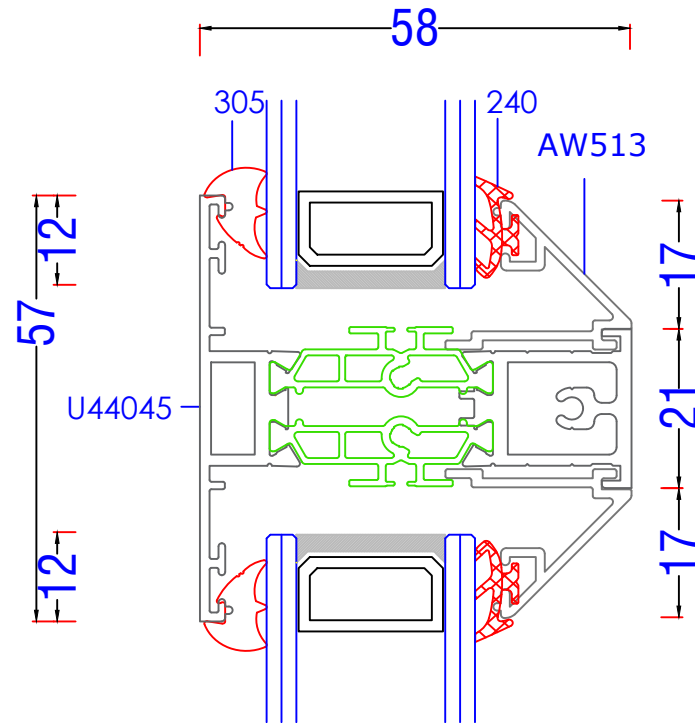
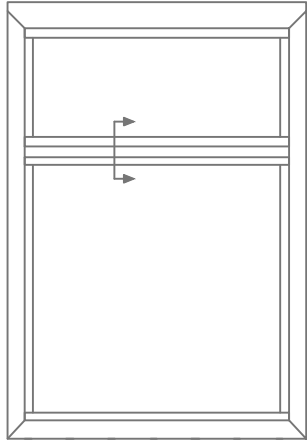

AL UK 58BW HI - Open to Fixed Transom

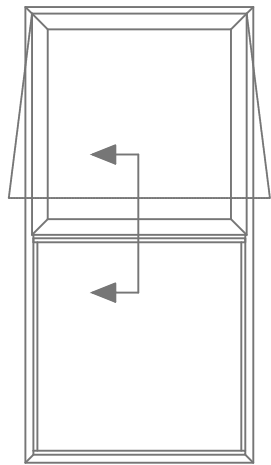

INSIDE

OUTSIDE

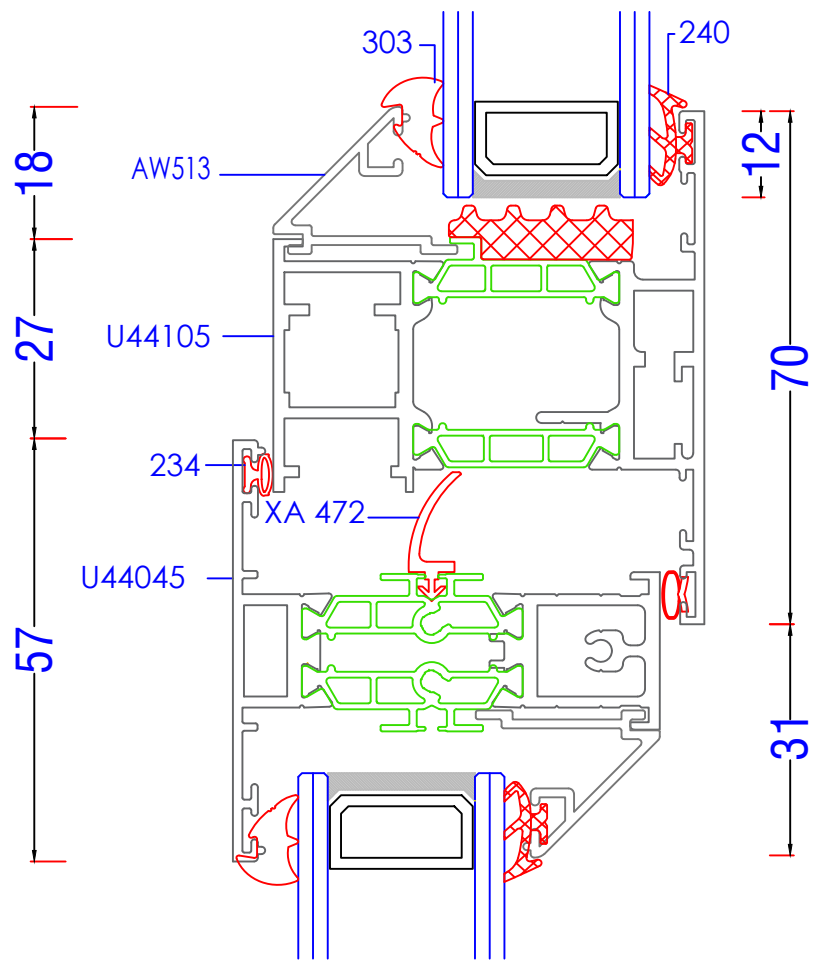

AL UK 58BW - Baypole

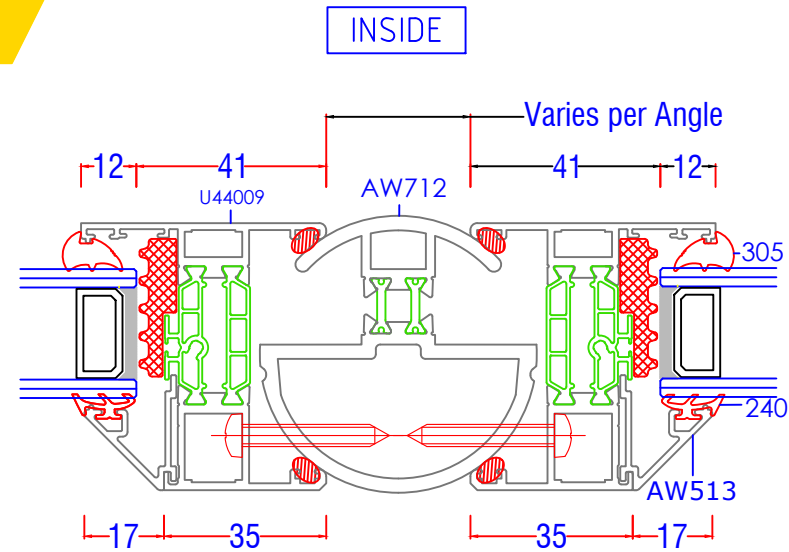
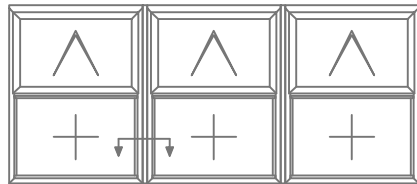

Fixing Ref Ø4.2mm x 35mm Pozi pan S/S Self tapping screw @ 300mm centres

INSIDE

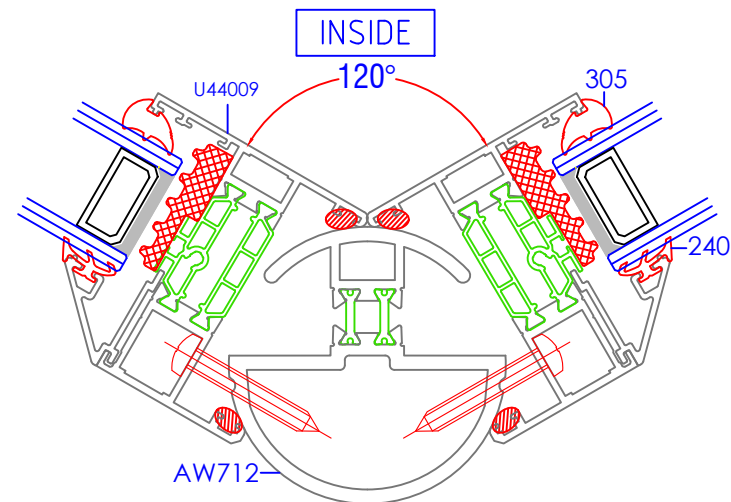

Fixing Ref Ø4.2mm x 35mm Pozi pan S/S Self tapping screw @ 300mm centres

OUTSIDE

AL UK 58BW HI- 90° Corner Post

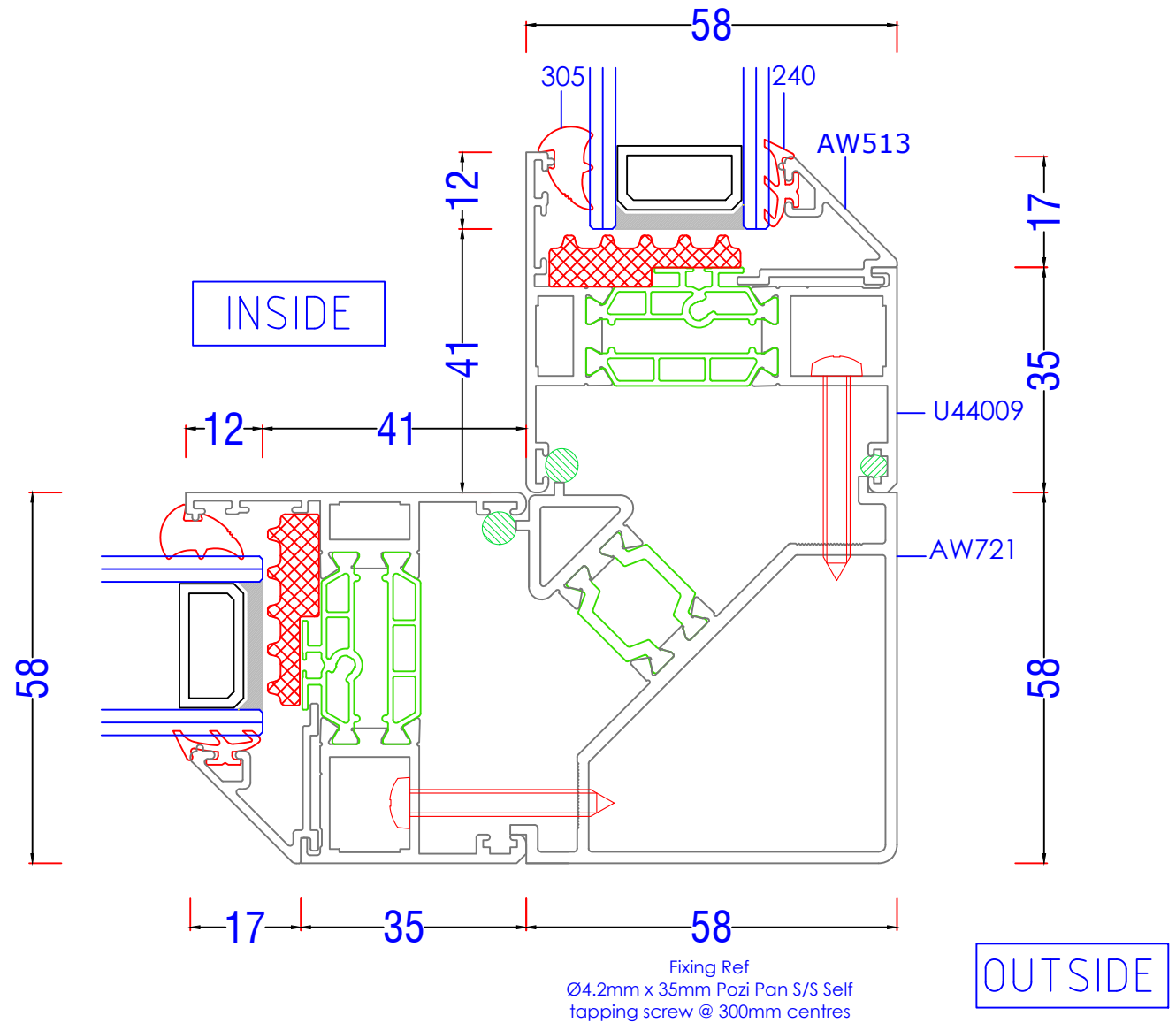
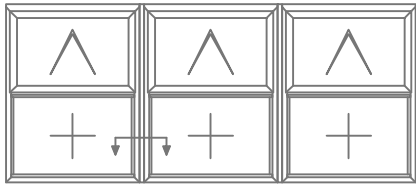

AL UK 58BW - 20m Frame Extender

