



Arkay Windows

TECHNICAL DOCUMENTS

Aluk 58BD HI Resi Doors

Residential Door - 58BD HI

58BD HI ENTRANCE DOOR

Available in a wide range of styles and formats, our stylish aluminium Entrance door system is suitable for both light and medium-duty use. Designed with security and flexibility front of mind, every door in the range is available in single and double configurations making them ideal for almost any application.

PRODUCT FEATURES

- Certified under the Secured By Design scheme
- Multi-point locking mechanism
- Part L compliant for new build and replacement
- Intergrated deep head for trickle vents
- PAS24 Certified

OPTIONS

- Glazing 24mm – 40mm
- 58mm or 70mm frame depth
- Low threshold option
- Single, dual and anodised finishes
- Available in single or double door configuration
- Standard, Thumbturn & 3* cyclinders options
- Electric lock available
- Door Restrictors available



Meeting Stile Detail

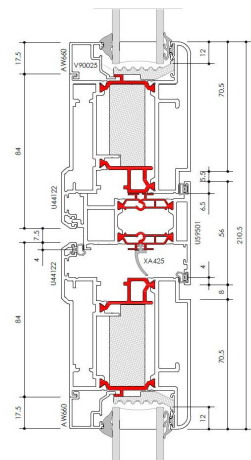

Cill Detail Low Threshold

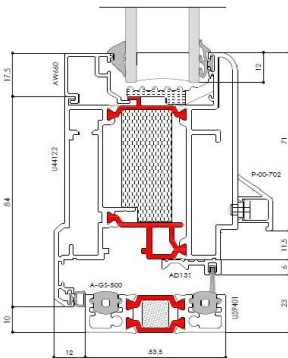

Cill Detail Standard Threshold

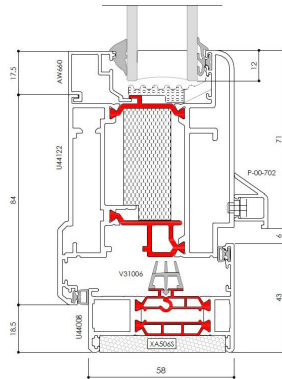

SPECIFICATIONS

PERFORMANCE & ACCREDITATION	SINGLE OPEN IN	SINGLE OPEN OUT	DOUBLE OPEN IN	DOUBLE OPEN OUT
Air permeability	Class 4 (600 Pa)	Class 4 (600 Pa)	Class 3 (600 Pa)	Class 3 (600 Pa)
Water penetration	Class 3a (100 Pa)	Class 7a (300 Pa)	Class 7a (300 Pa)	Class 9a (600 Pa)
Wind resistance	Class A3 (1200 Pa)	Class AE2400 (2400 Pa)	Class A3 (1200 Pa)	Class A4 (1600pa)
Building regulations part L	<input type="checkbox"/>	<input type="checkbox"/>	<input type="checkbox"/>	<input type="checkbox"/>
Building regulations part M	<input type="checkbox"/>	<input type="checkbox"/>	<input type="checkbox"/>	<input type="checkbox"/>
•U-value (double glazing)	1.3 W/m²K	1.3 W/m²K	1.3 W/m²K	1.3 W/m²K
†U-value (triple glazing)	1.1 W/m²K	1.1 W/m²K	1.1 W/m²K	1.1 W/m²K
3rd party certification	Q-mark	Q-mark	Q-mark	Q-mark
PAS24 Certified	<input type="checkbox"/>	<input type="checkbox"/>	<input type="checkbox"/>	<input type="checkbox"/>
Secured by design	Yes	Yes	Yes	Yes
Durability EN1191 category	50,000 Cycles	50,000 Cycles	50,000 Cycles	50,000 Cycles

DESIGN FEATURES

Minimum door leaf size	600mm x 1560mm	Sightline (Head)	120mm/130mm
Maximum door leaf size	1200mm x 2400mm	Low Threshold Sightline (Cill)	111 mm
Maximum door leaf weight	90 kg	Sightline (Jamb)	130mm
Maximum glazing thickness	24mm - 40mm	Sightline (Meeting Stile)	210 mm

CILL OPTIONS

90mm stub cill	150mm cill	180mm cill	230mm cill	300mm cill
----------------	------------	------------	------------	------------

APPLICATIONS

New build	<input type="checkbox"/>	<input type="checkbox"/>	<input type="checkbox"/>	<input type="checkbox"/>
Refurbishment	<input type="checkbox"/>	<input type="checkbox"/>	<input type="checkbox"/>	<input type="checkbox"/>

HANDLE OPTIONS

LEVER HANDLE	POLE HANDLE	PAD HANDLE
White lever/lever	1200 S/S Pole & Lever	White lever/pad
Black lever/lever	1200 S/S Pole in & Out	Black lever/pad
Grey lever/lever	1500 S/S Pole & Lever	Silver lever/pad
Silver lever/lever	1500 S/S Pole in & Out	Chrome lever/pad
Chrome lever/lever	1800 S/S Pole & Lever	Gold lever/pad
Gold lever/lever	1800 S/S Pole in & Out	
Dual lever/lever		
Lever/Blank Plate		

COLOURS

Standard Colours	RAL7016 Matt Grey	RAL 9005 Matt Black	RAL 9910 Gloss White
------------------	-------------------	---------------------	----------------------

We are able to manufacture in over 200 single, dual and anodised finishes to match your project

* U-Value (Double Glazing) - Single Doors are calculated using EN ISO 10077 - Part 2, 1000mm x 2180mm Single Door with Ug: 1.0 W/m²K using AW604 outerframe and AD200/AD201 vent. Double Doors are calculated using EN ISO 10077 - Part 2, 2000mm x 2 using AW604 outerframe and AD200/AD201 vent.
 † U-Value (Triple Glazing) - Single Doors are calculated using EN ISO 10077 - Part 2, 1000mm x 2180mm Single Door with Ug: 0.7 W/m²K using AW604 outerframe and AD200/AD201 vent. Double Doors are calculated using EN ISO 10077 - Part 2, 2000mm x 2 using AW604 outerframe and AD200/AD201 vent.

58BD HI - Contents

- 1.0 Typical Elevations
- 2.0 Standard Profiles
- 3.0 Typical Sections
 - 3.1 Threshold - Rebated Frame Open Out
 - 3.2 Threshold - Low Threshold Open Out
 - 3.3 Threshold - Rebated Frame Open In
 - 3.4 Threshold - Low Threshold Open In
 - 3.5 Head - Open Out
 - 3.6 Head - Open In
 - 3.7 Head - Extended Frame with Trickle Vent
 - 3.8 Hinged Jamb - Open In
 - 3.9 Locking Jamb - Open Out
 - 3.10 Hinged Jamb - Open In
 - 3.11 Locking Jamb - Open In
 - 3.12 French Door - Meeting Open Out
 - 3.13 French Door - Meeting Open In
 - 3.14 AD309 - 110 Midrail
 - 3.15 Threshold - Rebated Frame Sill Options
 - 3.16 Threshold - Low Threshold Sill Options
 - 3.17 Frame - Concealed Coupler
 - 3.18 Frame - Reinforced Coupler

58BD HI - Elevations

SINGLE RESIDENTIAL DOORS

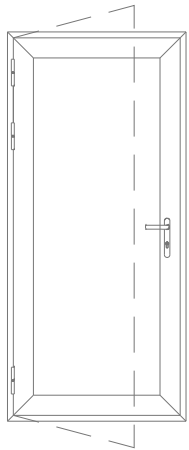

Left Hinged
Open Out

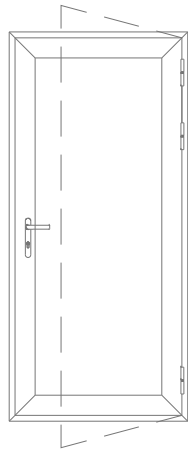

Right Hinged
Open Out

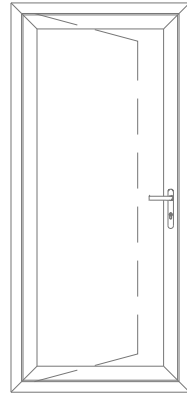

Left Hinged
Open In

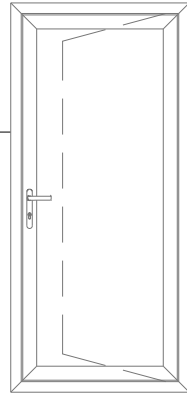

Right Hinged
Open In

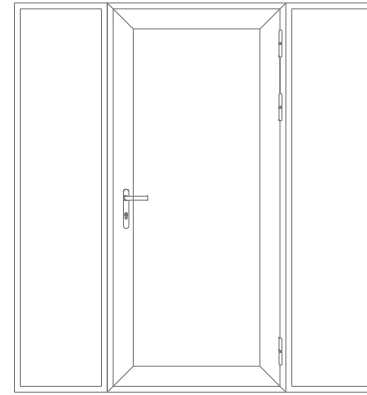

Right Hinged
Side Light



Left Hinged
Side Light

FRENCH RESIDENTIAL DOORS

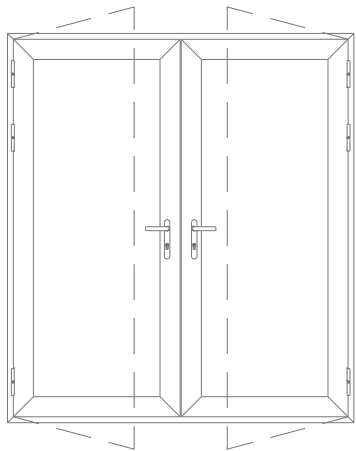

Left/Right Master
Open Out

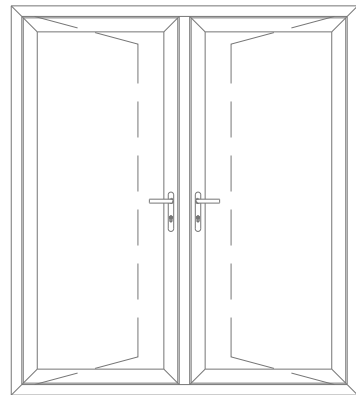

Left/Right Master
Open In

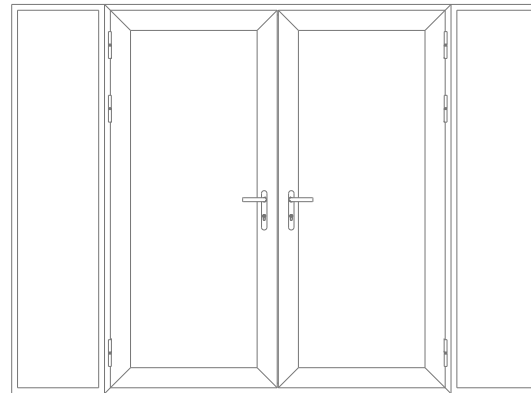

Left/Right Master
Side Light

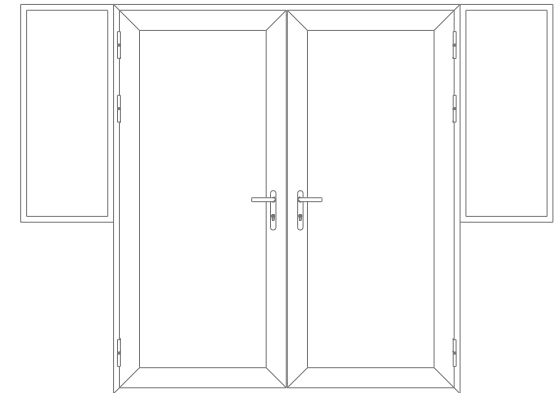

Left/Right Master
Side Light

58BD HI - Profiles

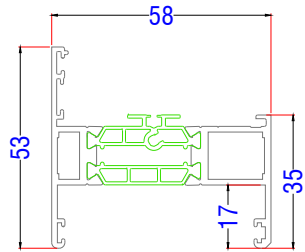

U44009 - Outer Frame

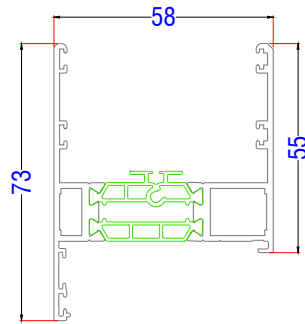

U44012 - Deep Outer Frame

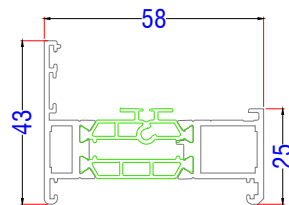

U44008 - Outer Frame

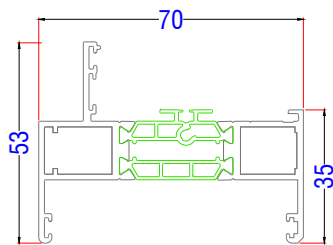

U44013 - Outer Frame

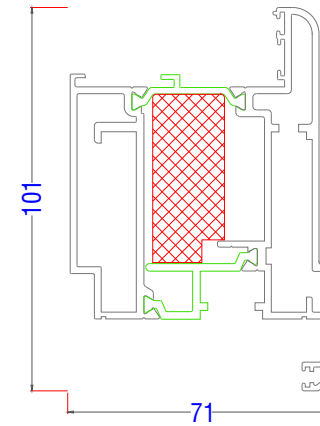

U44121 - Feature Door Leaf Open Out

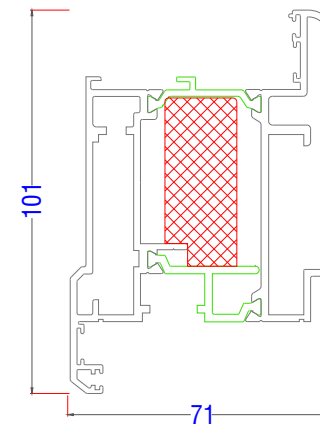

U44122 - Feature Door Leaf Open In

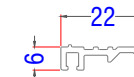

AD131 - Threshold Adaptor

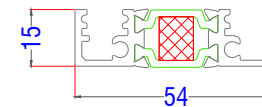

U59401 - Low Threshold 15mm

58BD HI - Profiles

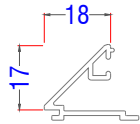

AW513 - Revealed Beam 28mm IGU

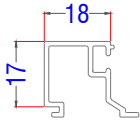

AW660 - Square Bead 28mm IGU

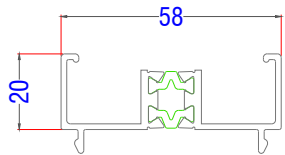

AW725 - 20mm Frame Extender (58mm)

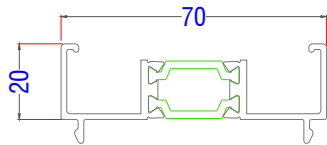

AW724 - 20mm Frame Extender (70mm)

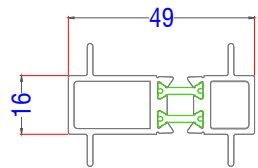

AW710 - Concealed Coupler

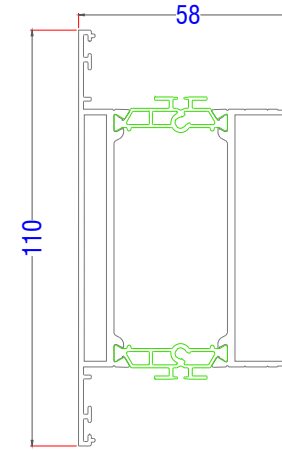

U44048 - Door Midrail 110mm

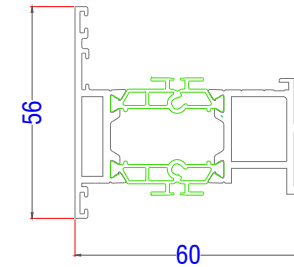

U59501 - Rebated Floating Mullion

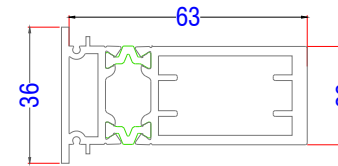

AW703 - 15mm Coupler Bar

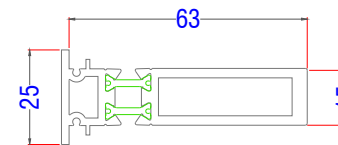

AW703 - 15mm Coupler Bar

58BD HI - Profiles

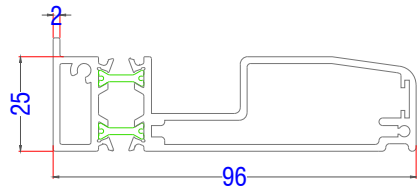

AW570 - 95mm Stub Nose Cill

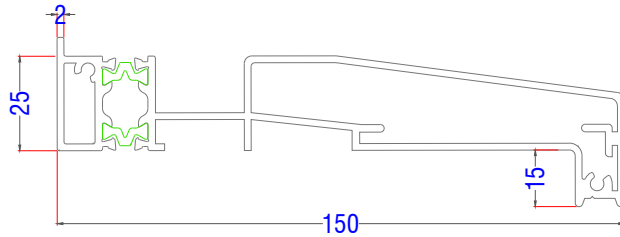

AW542 - 150mm Drop Nose Cill

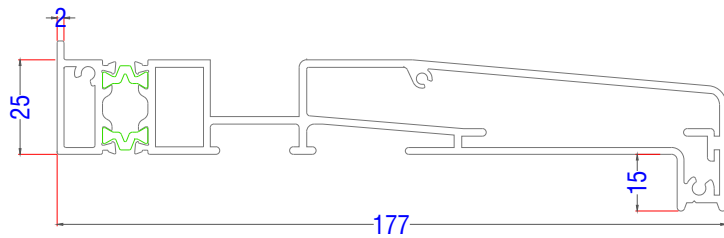

AW543 - 177mm Drop Nose Cill

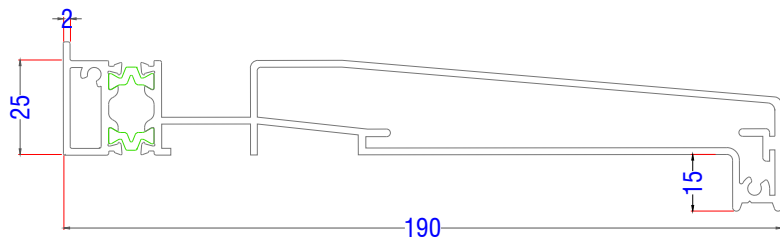

AW544 - 190mm Drop Nose Cill

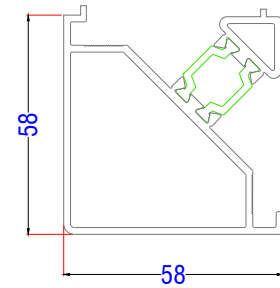

AW721 - 90deg Corner Post (58mm)

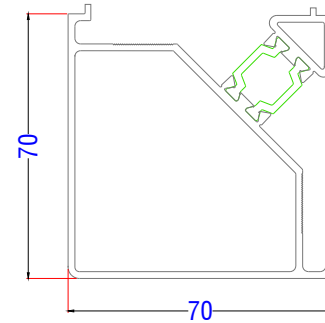

AW720 - 90deg Corner Post (70mm)

58BD HI - Typical Sections

Threshold - Rebated Frame Open Out

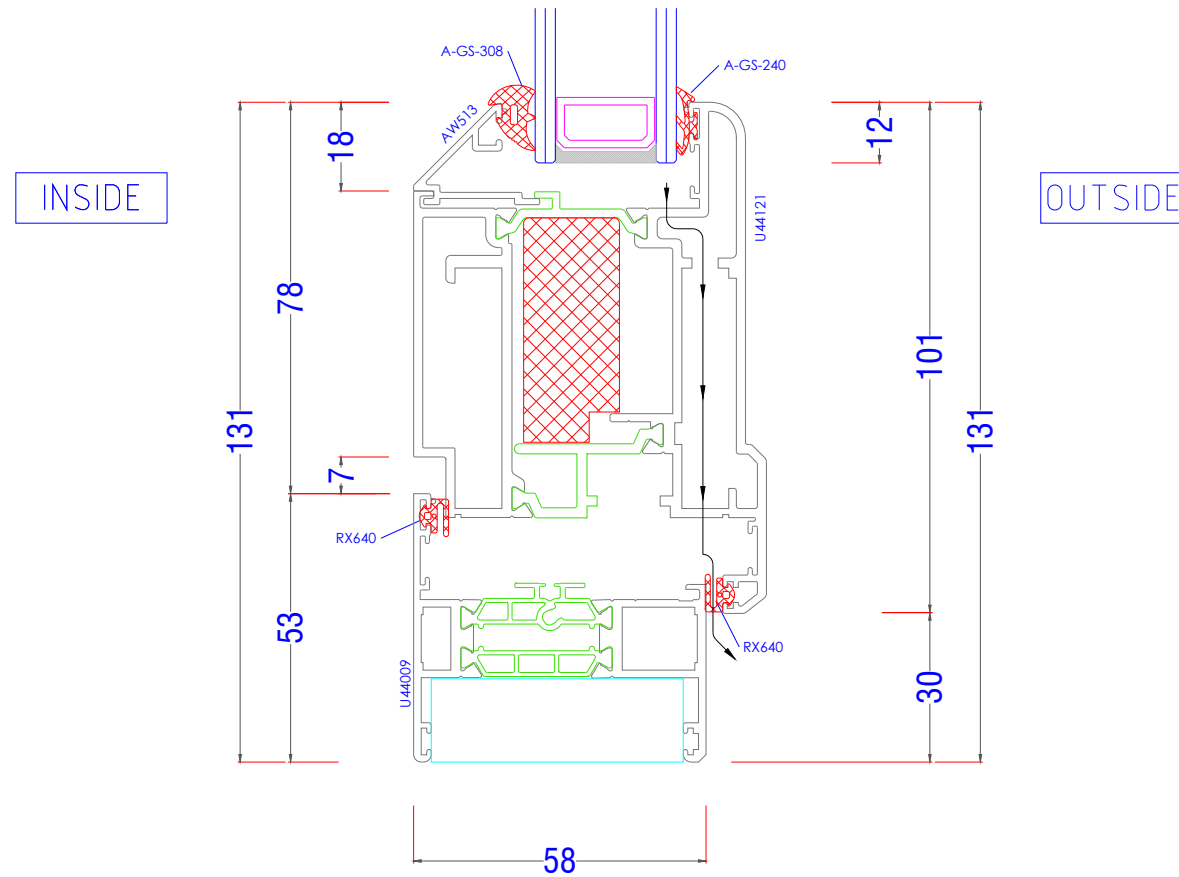
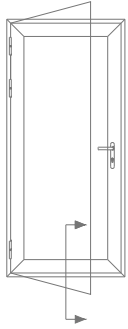

58BD HI - Typical Sections

Threshold - Low Threshold Open Out

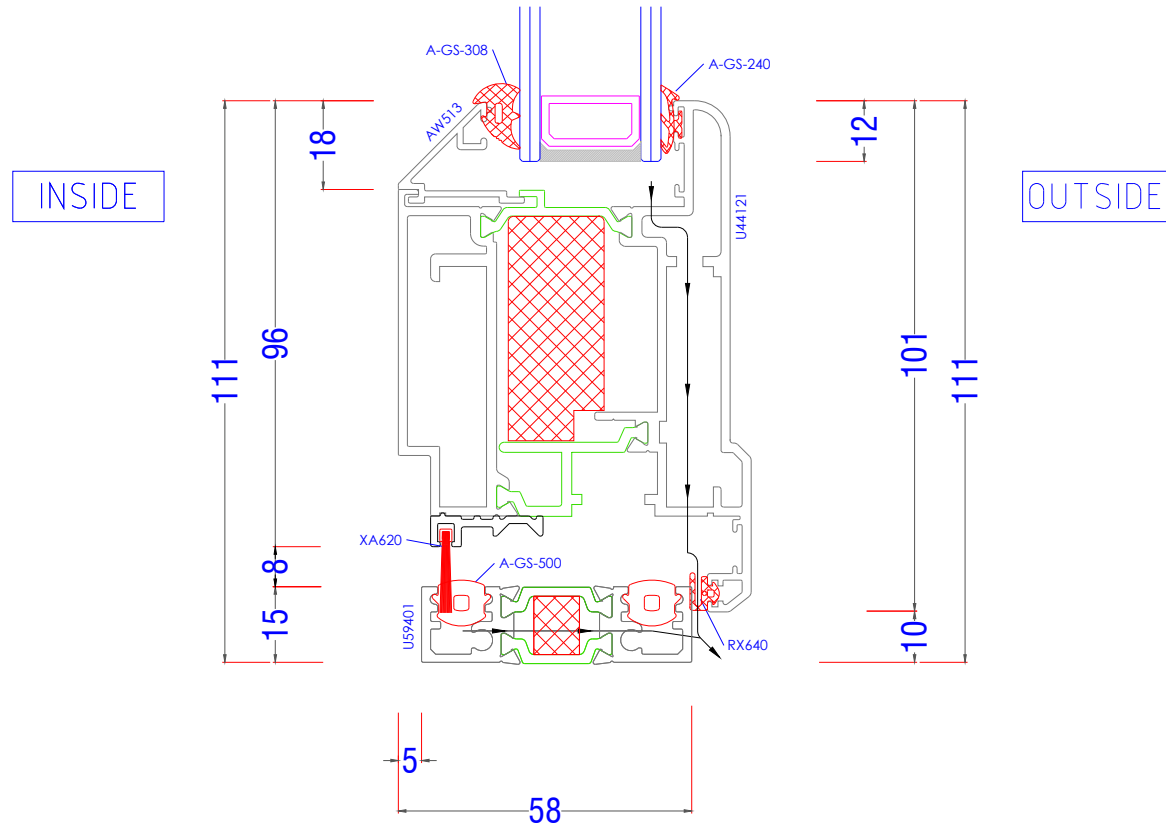
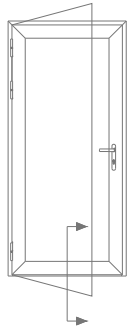

58BD HI - Typical Sections

Threshold - Rebated Frame Open In

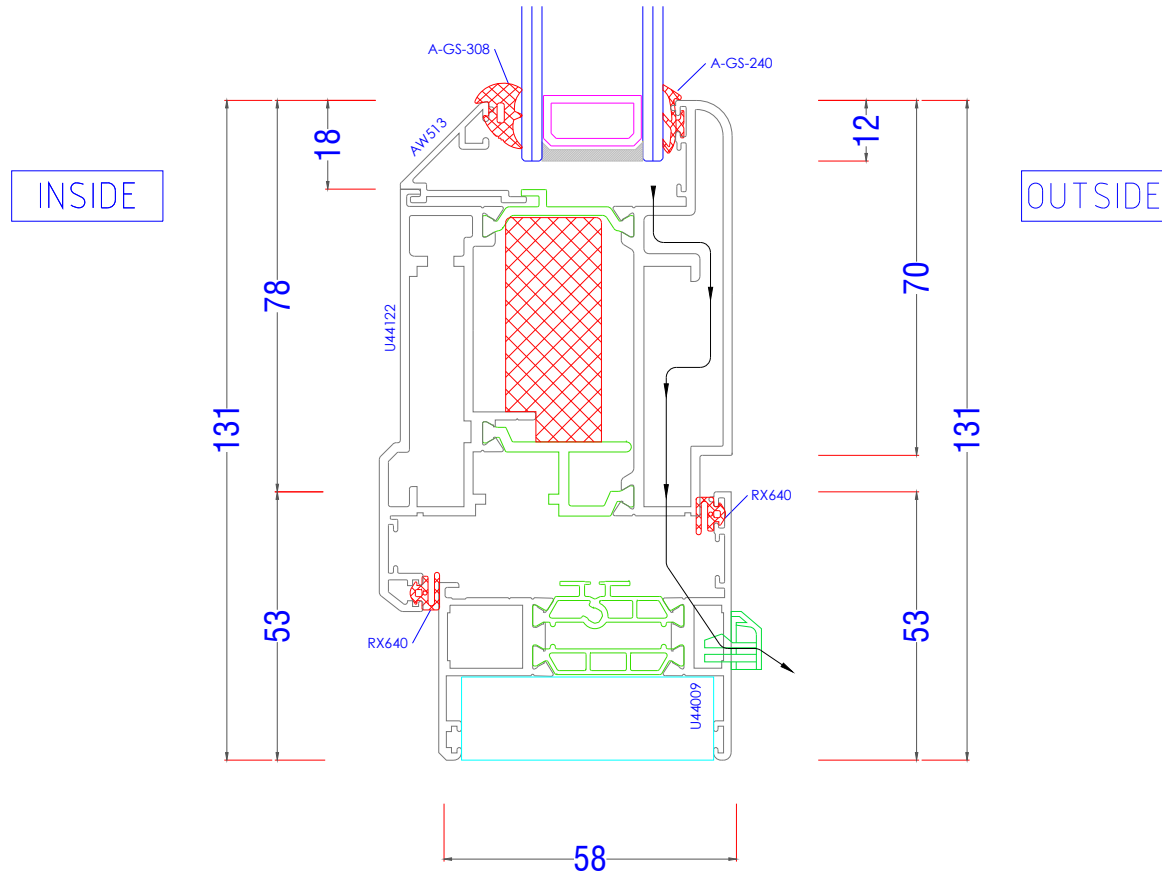
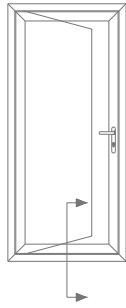

58BD HI - Typical Sections

Threshold - Low Threshold Open In

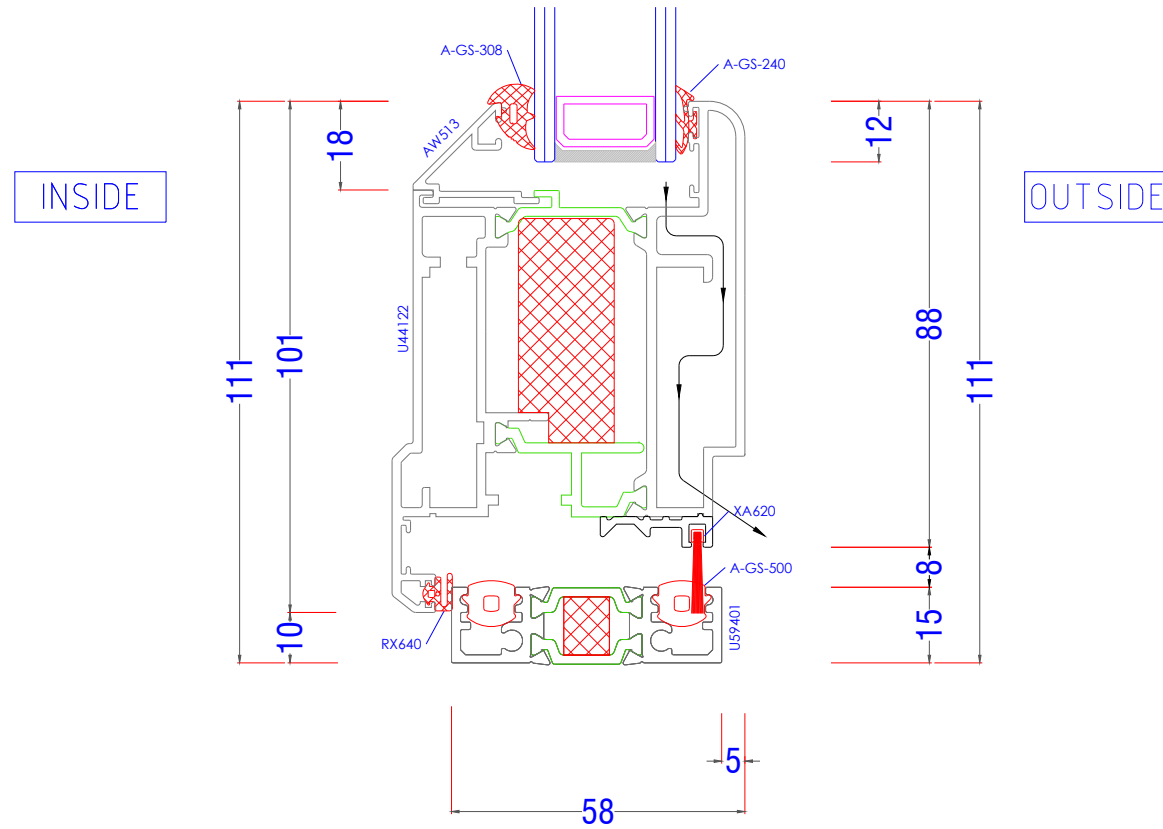
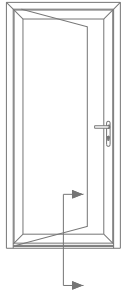

58BD HI - Typical Sections

Head - Open Out

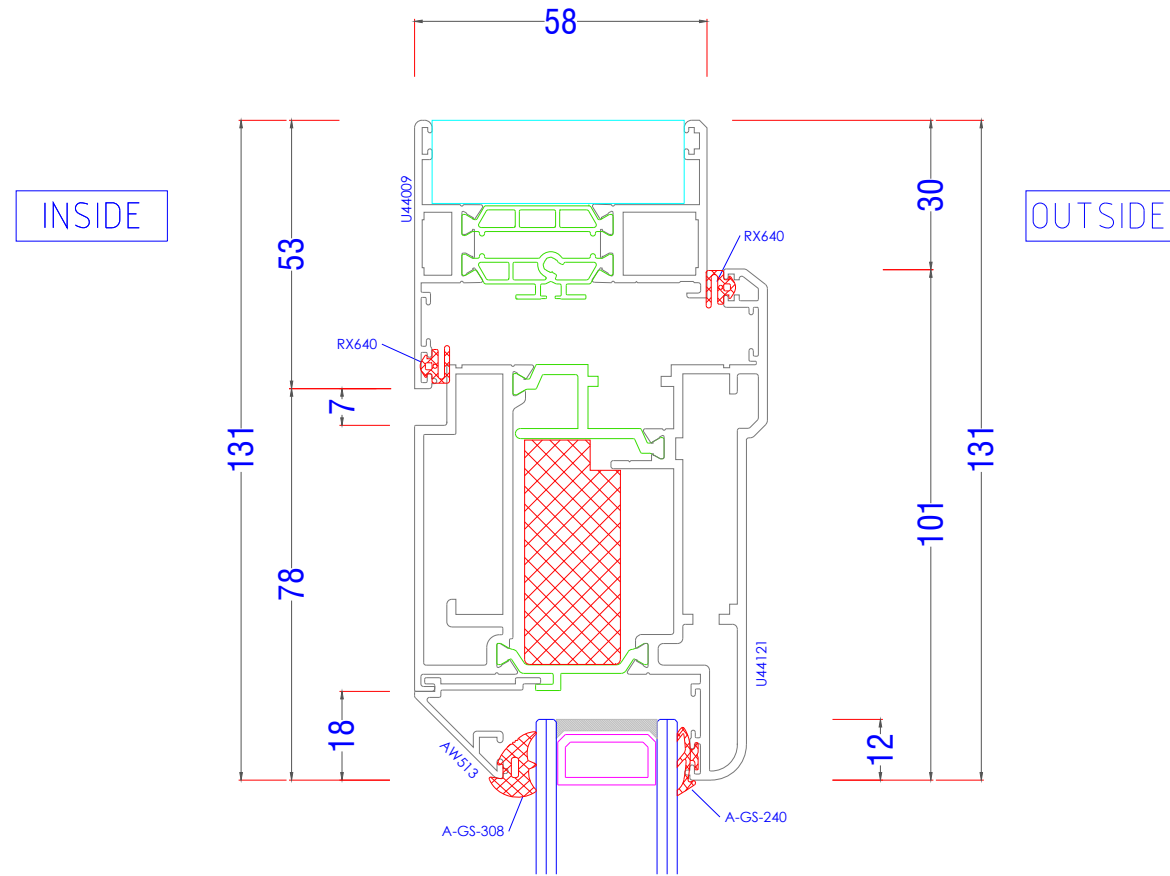
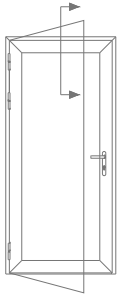

58BD HI - Typical Sections

Head - Open In

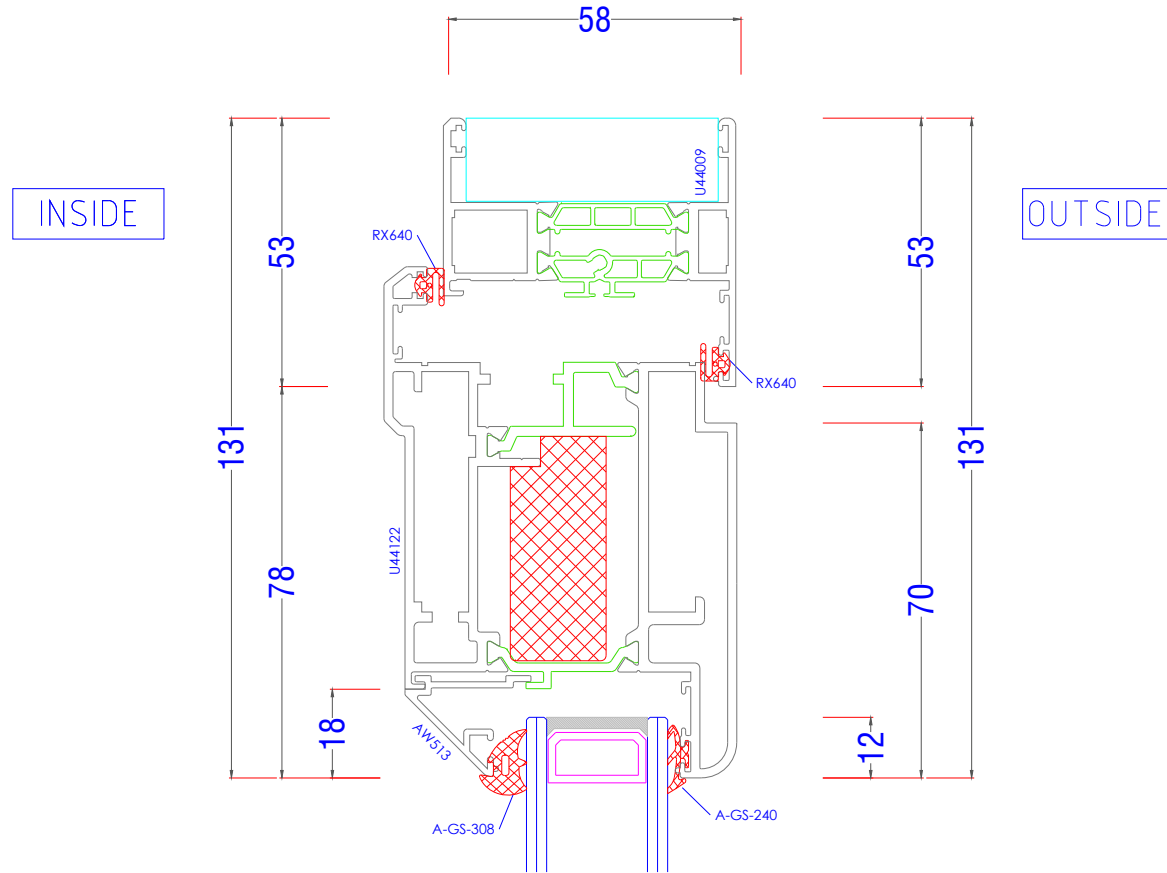
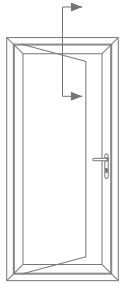

58BD HI - Typical Sections

Head - Extended Frame with Trickle Vent

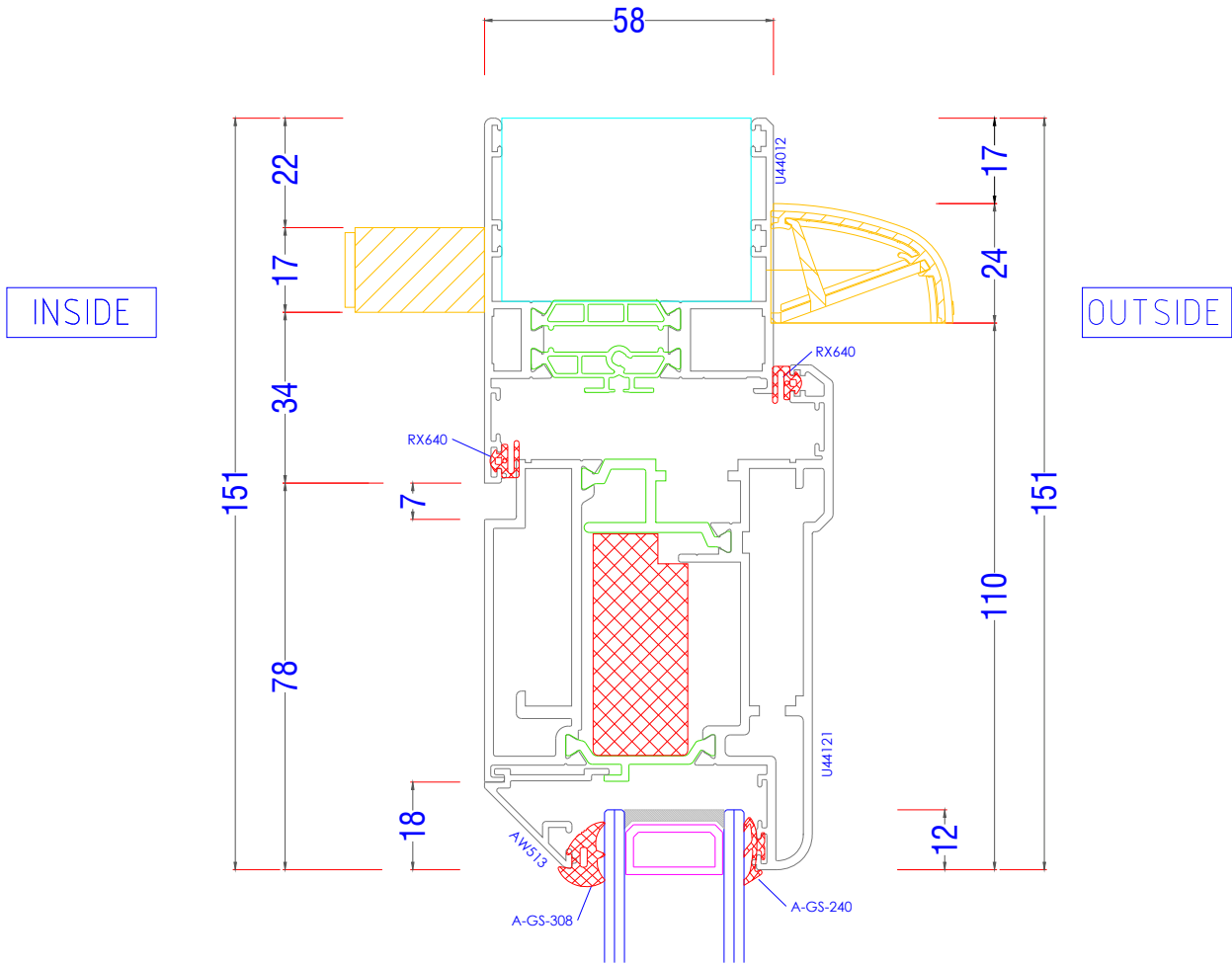

58BD HI- Typical Sections

Hinged Jamb - Open Out

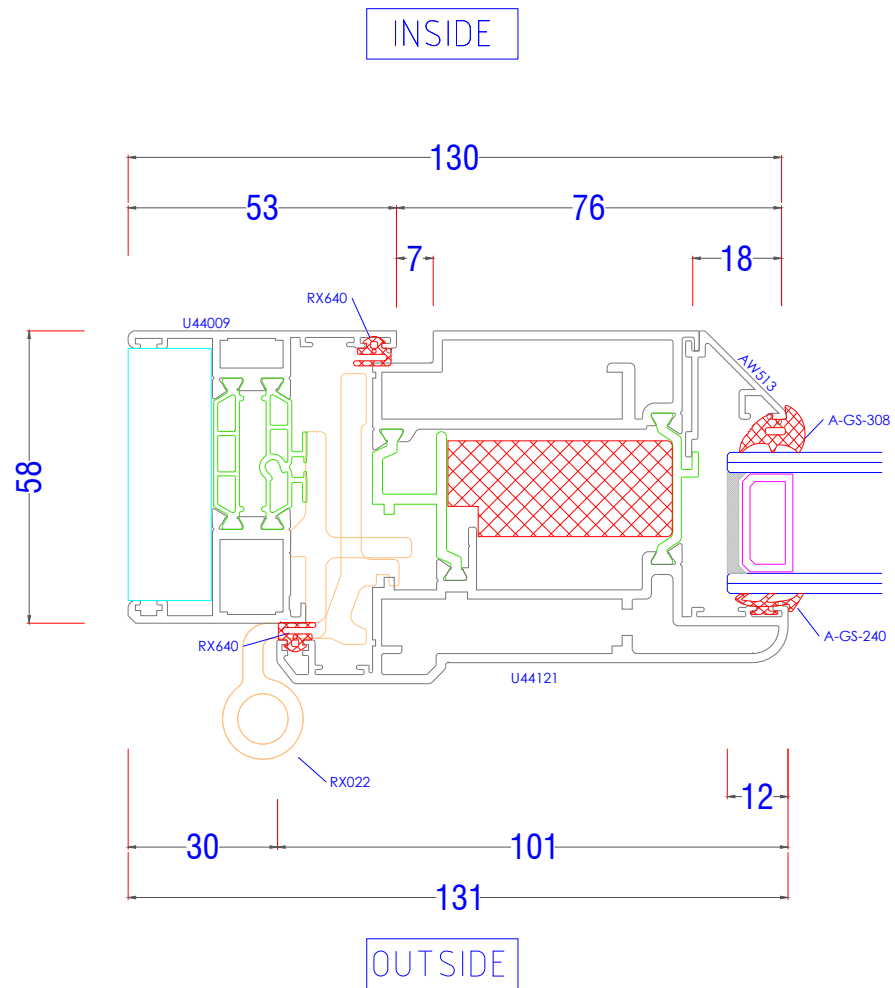
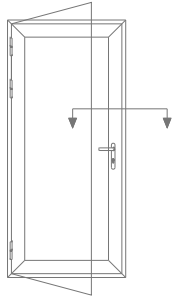

58BD HI - Typical Sections

Locking Jamb - Open Out

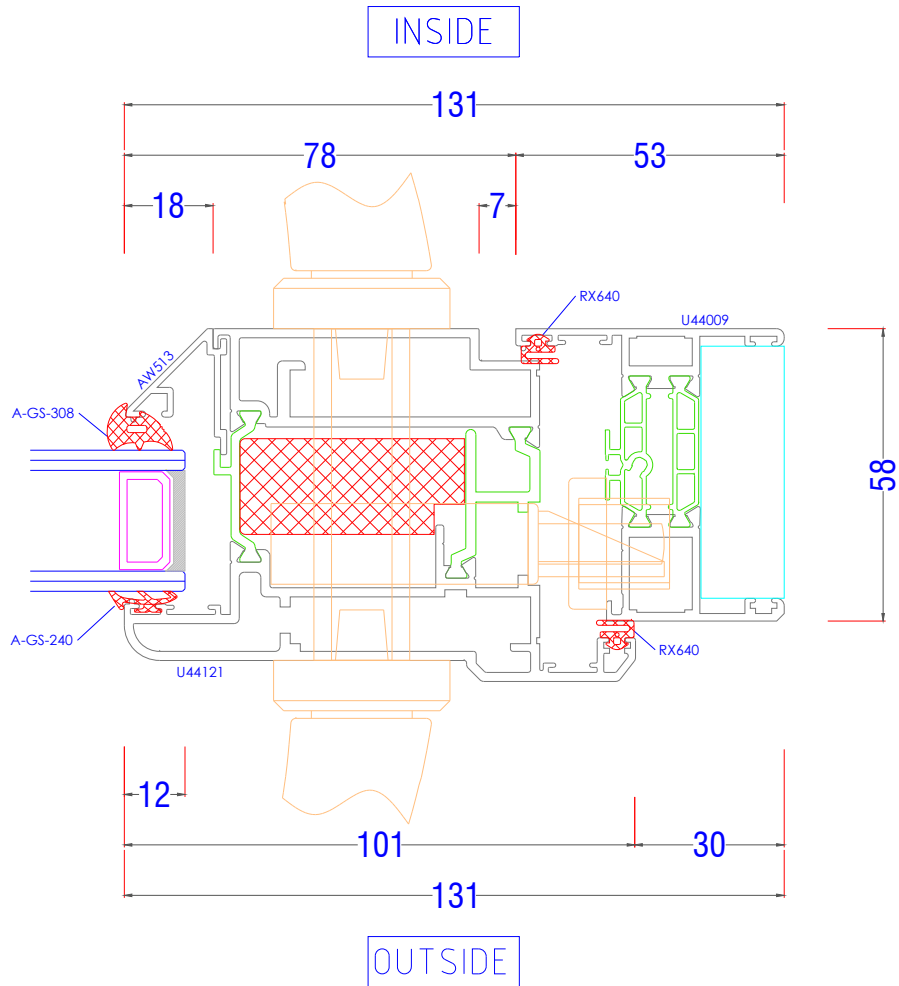
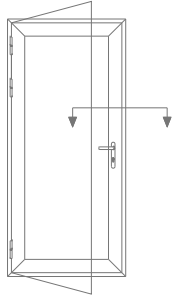

58BD HI - Typical Sections

Hinged Jamb - Open In

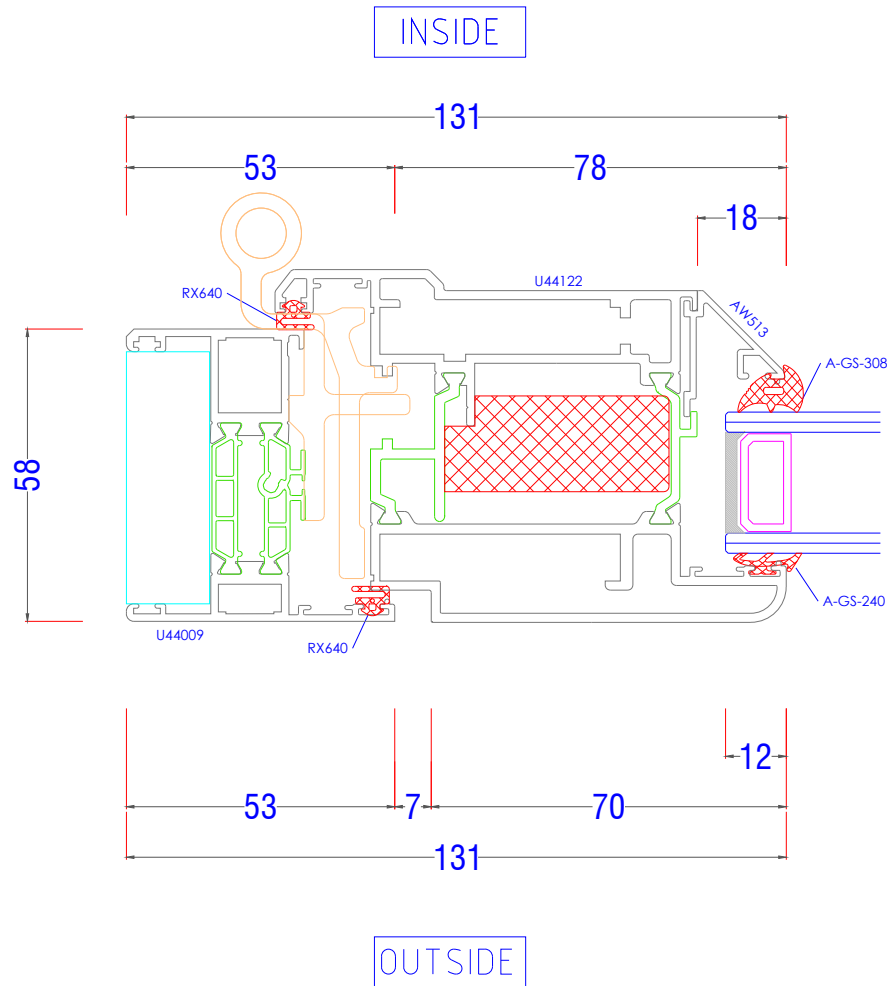
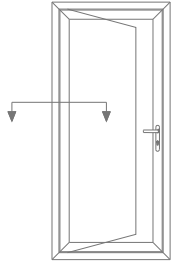

58BD HI - Typical Sections

Locking Jamb - Open In

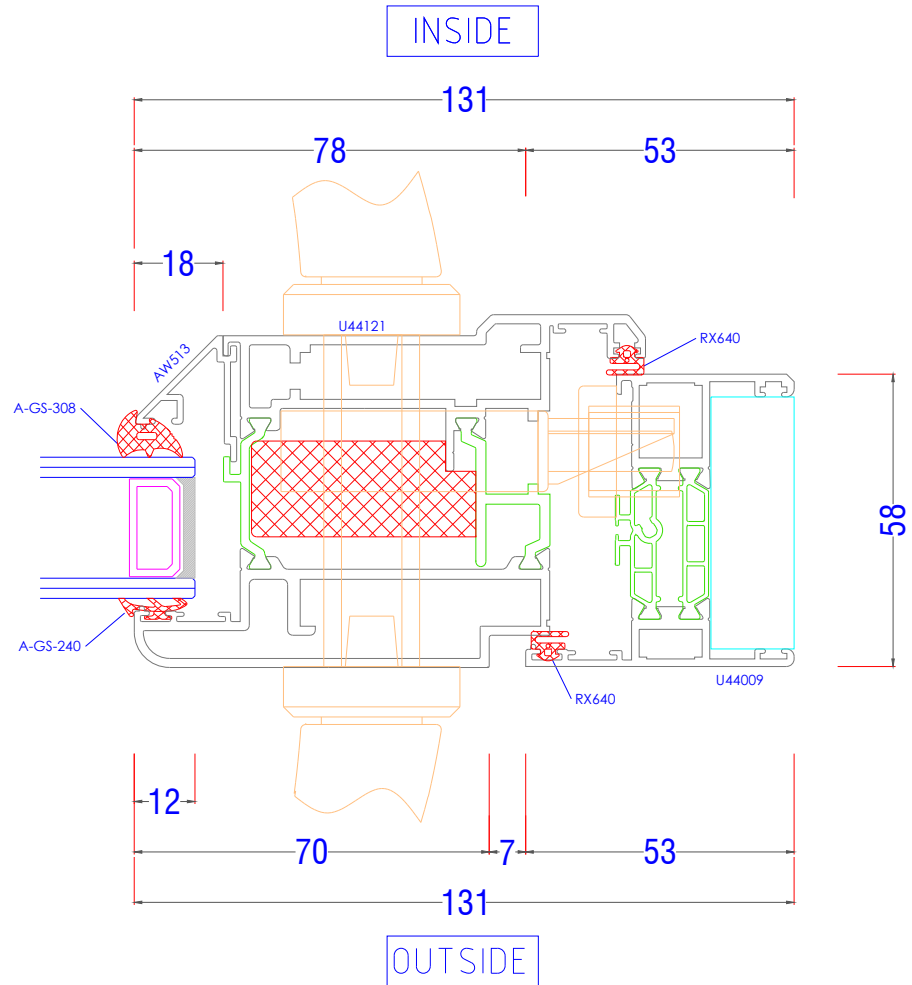
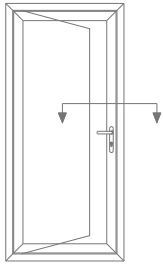

58BD HI - Typical Sections

French Door - Meeting Open Out

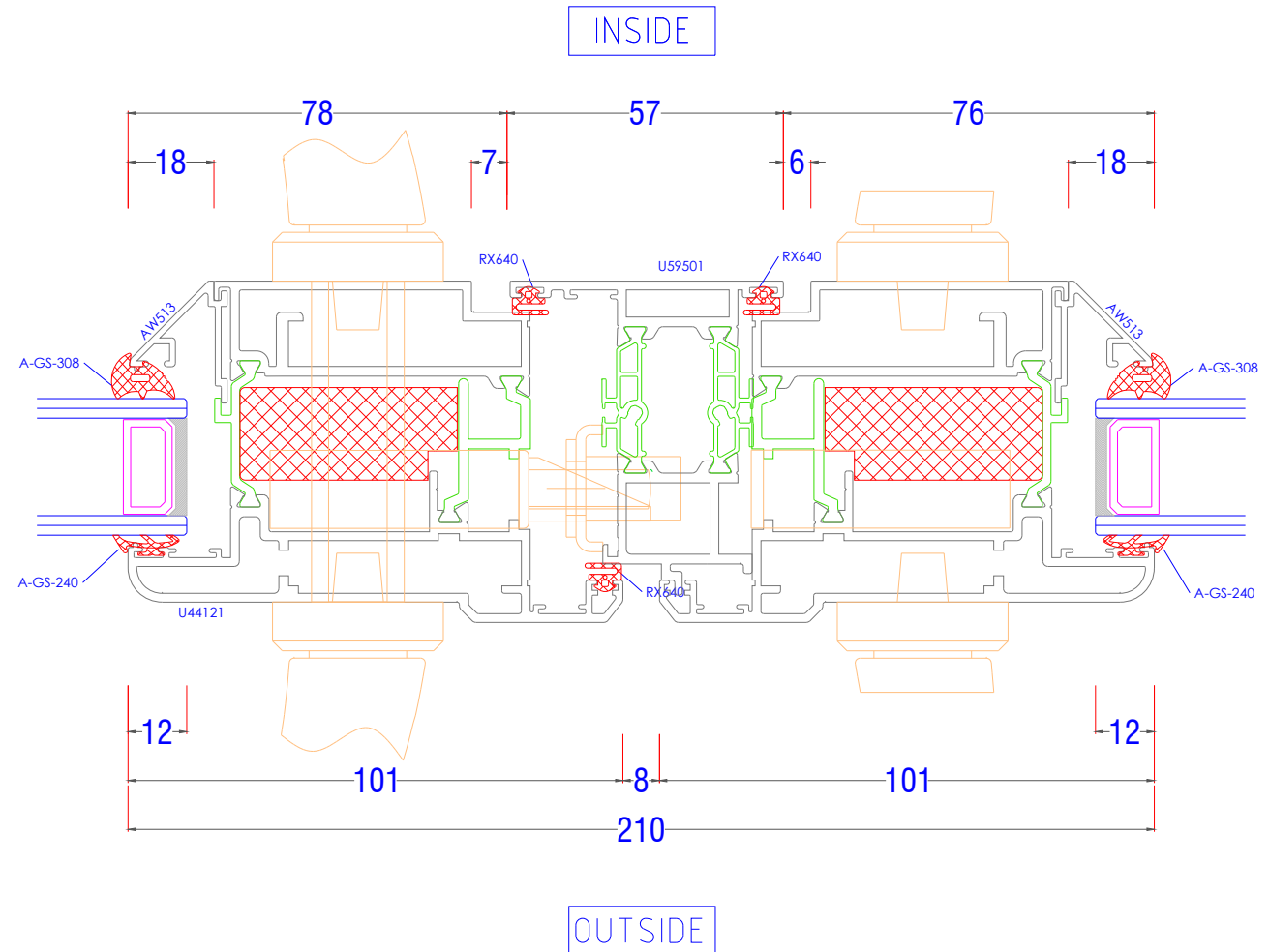
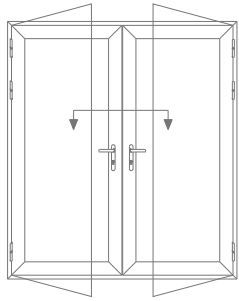

58BD HI - Typical Sections

French Door - Meeting Open In

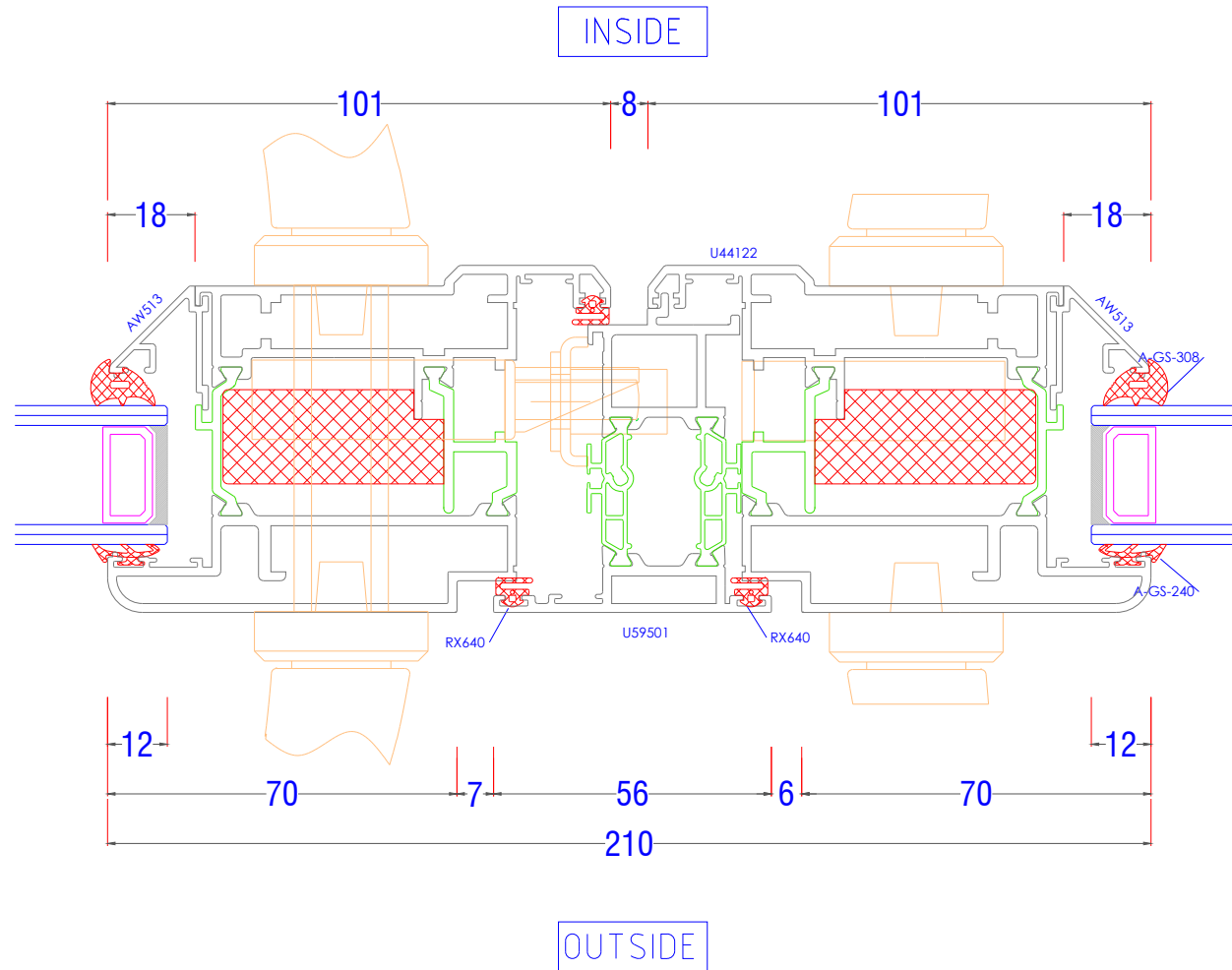
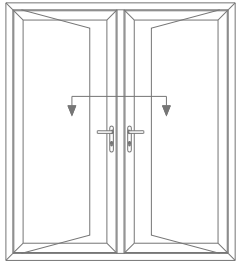

58BD HI - Typical Sections

AD309 - 110mm Midrail

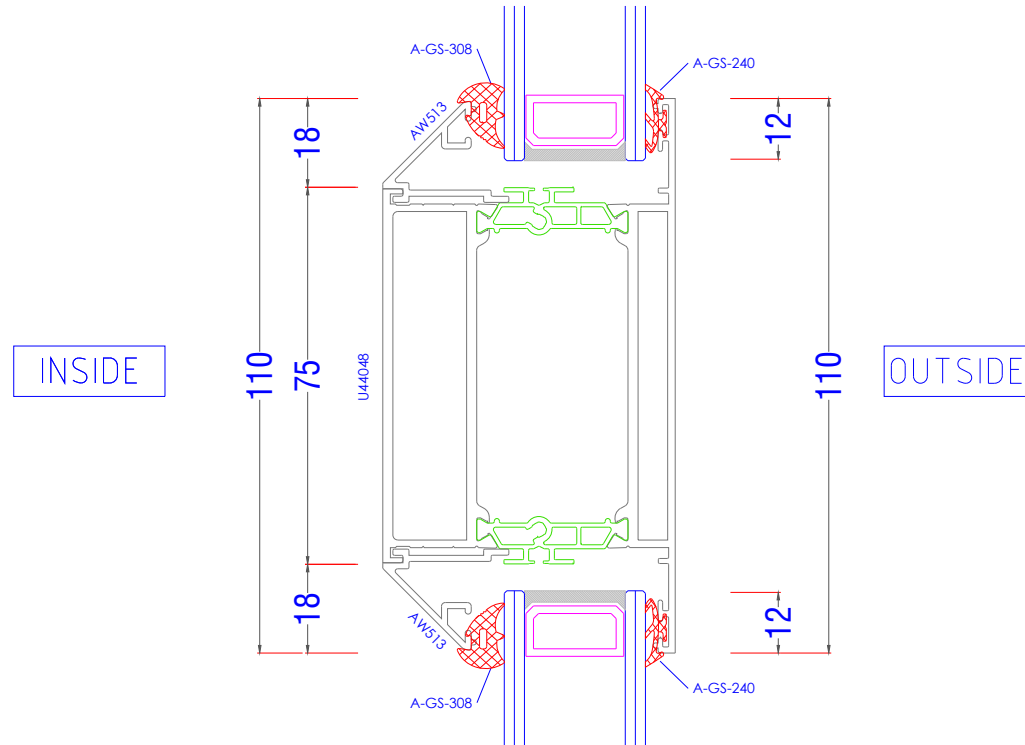
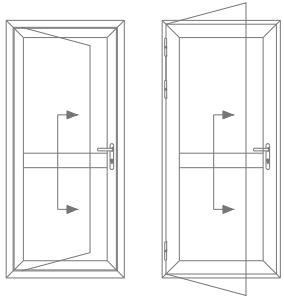

58BD HI - Typical Sections

Threshold - Rebated Frame Sill Options

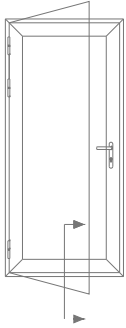

INSIDE

OUTSIDE

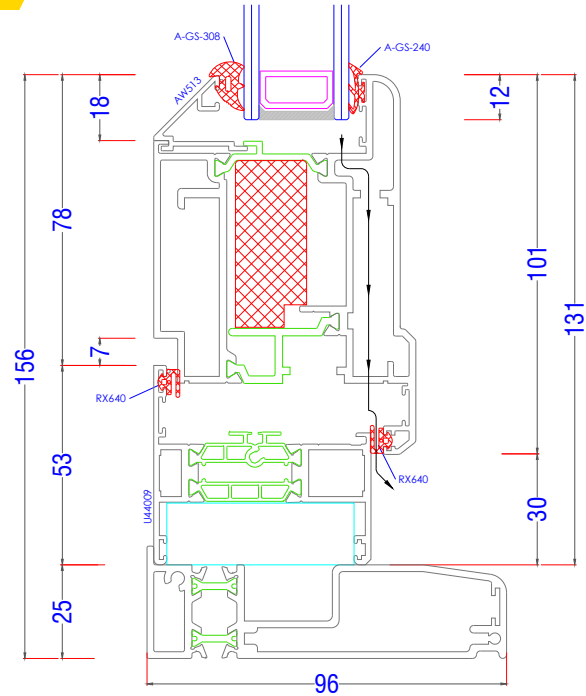

AW570 - 95mm Stub Nose Cill

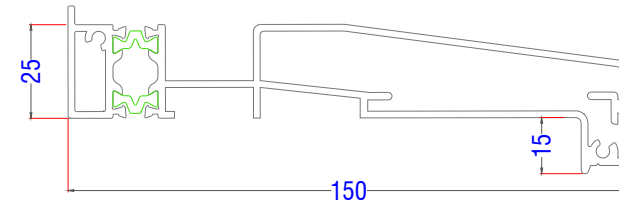

AW542 - 150mm Drop Nose Cill

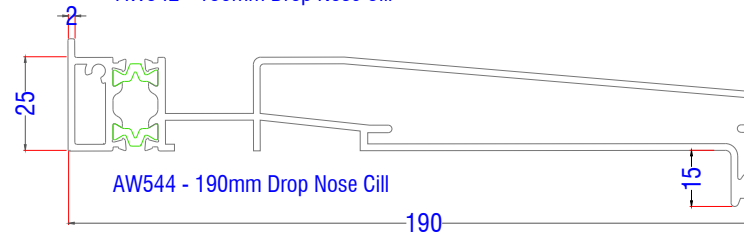

AW544 - 190mm Drop Nose Cill

58BD HI - Typical Sections

Threshold - Low Threshold Cill Options

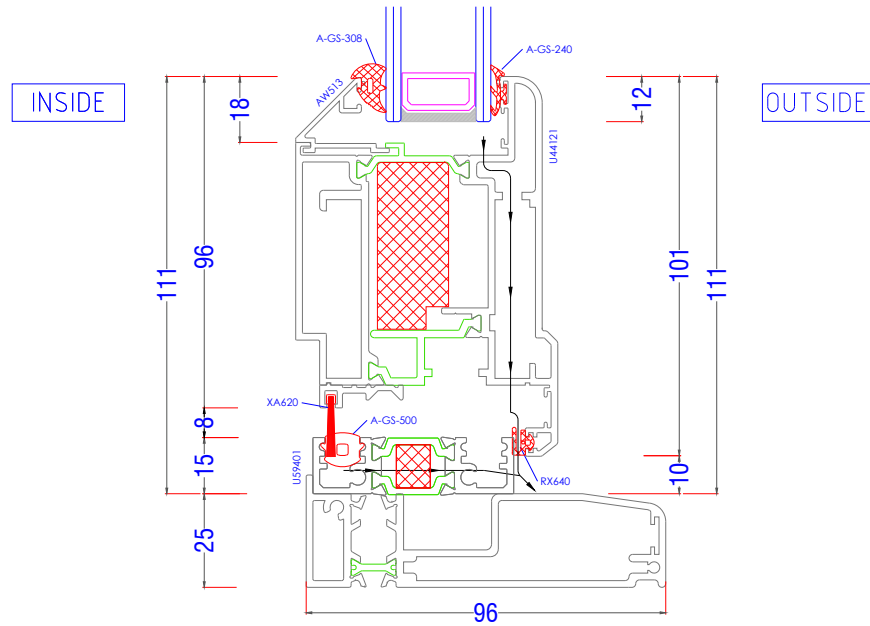
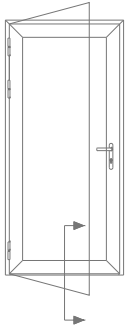

AW570 - 95mm Stub Nose Cill

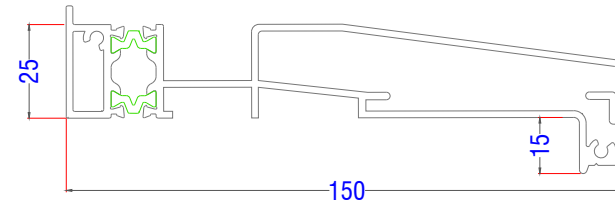

AW542 - 150mm Drop Nose Cill

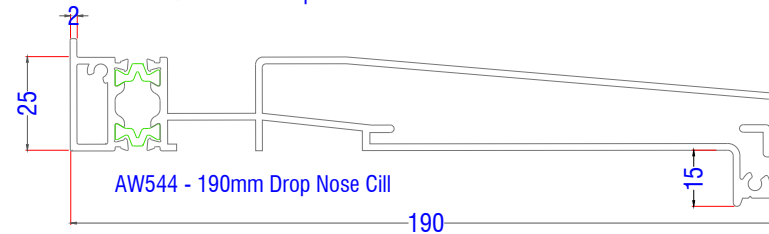

AW544 - 190mm Drop Nose Cill

58BD HI - Typical Sections

Frame - Concealed Coupler

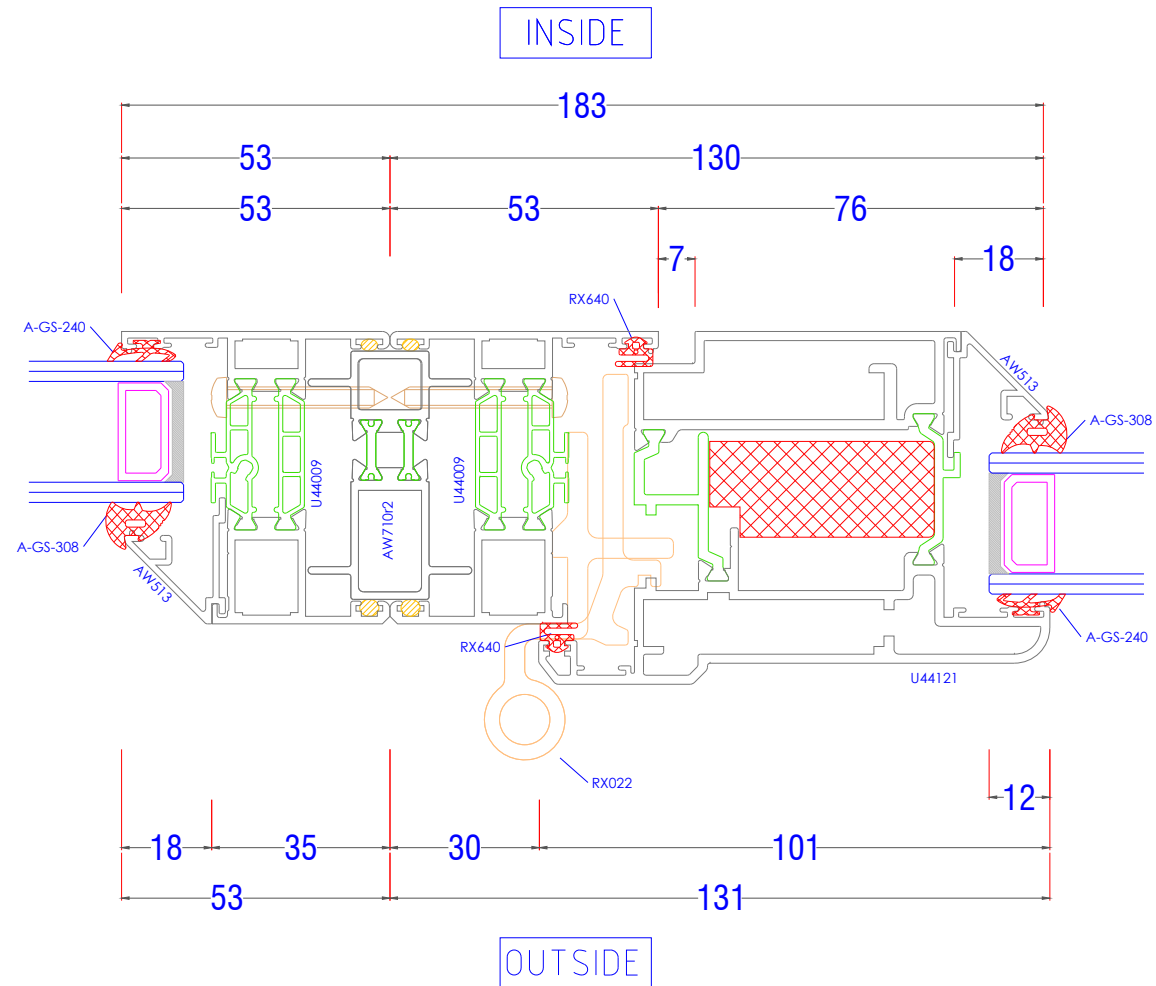
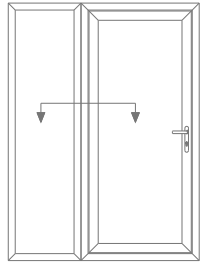

58BD HI - Typical Sections

Frame - Reinforced Coupler

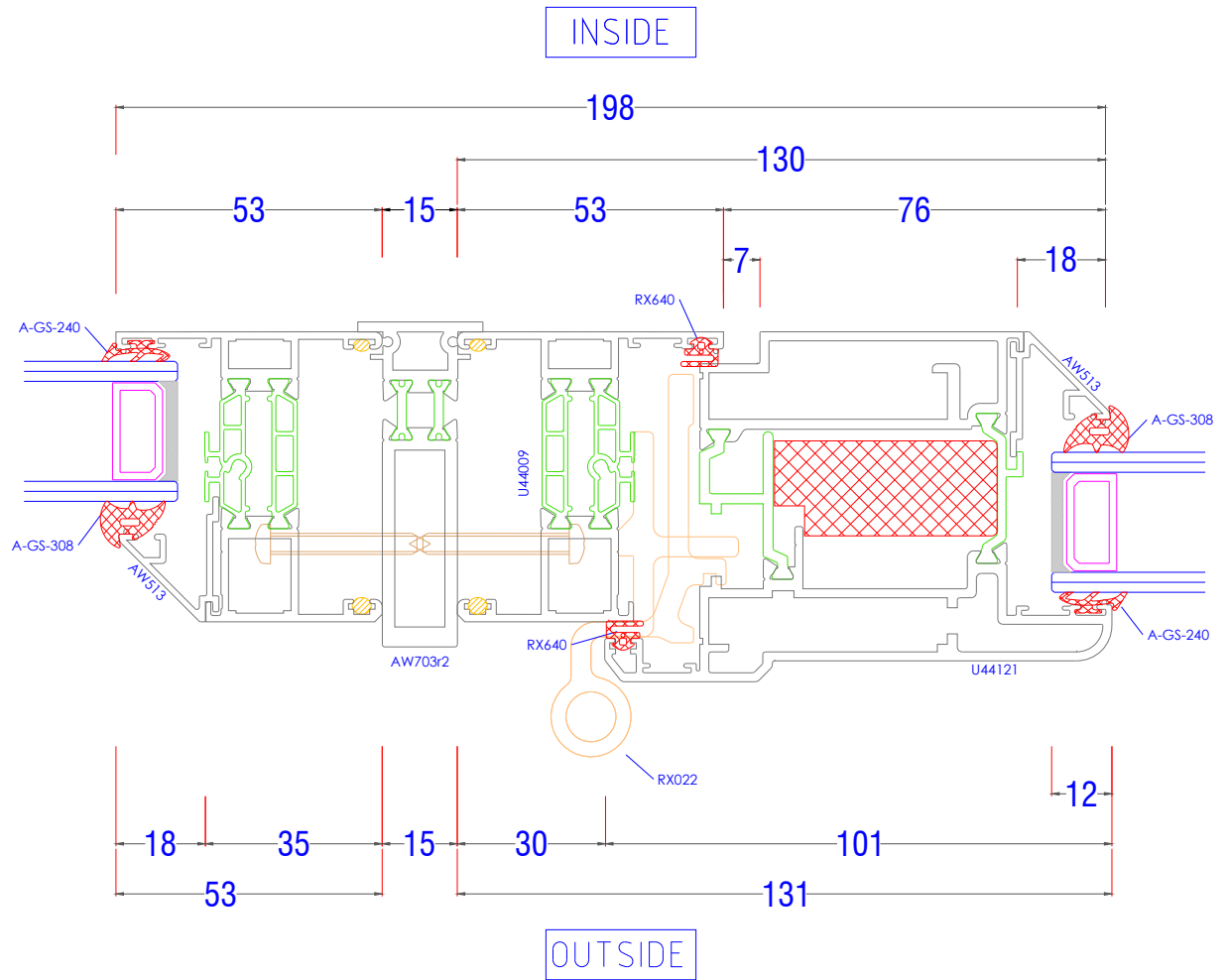
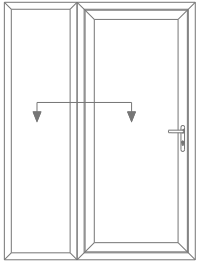



Class & Glazing Federation Member

Official Police Security Initiative

Arkay Windows is a specialist large-scale fabricator with over 30 years experience based in Watford, North West London.

Through growth built on putting our customers first, we have risen to supply some of the country's biggest retail companies, contractors and commercial installers.

Arkay Windows

Watford: 01923 803923
London: 020 8889 6821

sales@arkaywindows.com
www.arkaywindows.com

