



# Arkay Windows

## TECHNICAL DOCUMENTS

### EdgeGLIDE +

# EdgeGLIDE +



## EDGEGLIDE+

THE AMAZINGLY  
SLEEK NEW INLINE  
SLIDING DOOR

*Choose your design, choose your view. EdgeGlide* is the sleek sliding door which combines top quality, colour-matched hardware with elegant design. So the look of your door can match the look of your outdoors.

### Modern Square Look

Ultra Slim 35mm Interlock

Up to 2.2m x 2.6m per panel

Stylish Colour-Matched Hardware

U-Value From 1.2 W/m<sup>2</sup>K

Double or Triple Glazing

Multi-Point Locking

70mm Frame Depth For Easy Replacement

Kit Frame and Sash Option For Full Site-Assembly

## EDGEGLIDE+

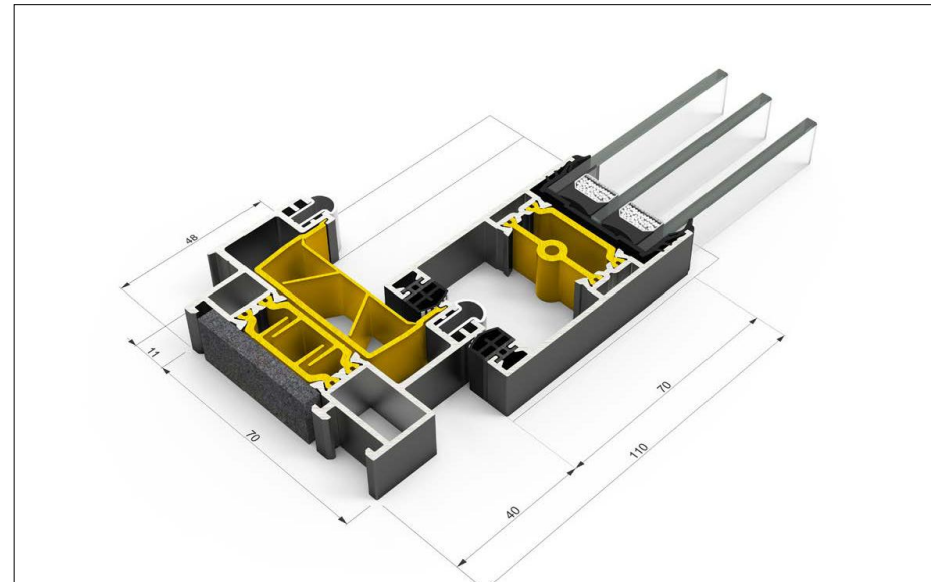

### Size Limits

Maximum Panel Width 2200 mm

Maximum Panel Height 2600 mm

Maximum Panel Weight 240 kg

THRESHOLD HEIGHT	48 mm	
GLAZING THICKNESS	14 - 36 mm	
GLAZING METHOD	Wrap-Around	
GLAZING	Double or Triple	
SIGHTLINE (TYPICAL)	35 mm	
FRAME DEPTH	2 RAIL	70 mm
FRAME DEPTH	3 RAIL	126 mm

PERFORMANCE	
U-VALUE	From 1.2 W/m <sup>2</sup> K
AIR PERMEABILITY	Class 4
WATER TIGHTNESS	Class 7A
WIND RESISTANCE	Class C5
ENHANCED SECURITY	Multi-Point Locking
MAXIMUM ACOUSTIC INSULATION	40 dB Rw

# EdgeGLIDE+ - Contents

- 1.0 Typical Elevations
- 2.0 Standard Profiles
- 3.0 Typical Sections
  - 3.1 Duo Frame - Locking Jamb
  - 3.2 Tri Frame - Locking Jamb
  - 3.3 Duo Frame - Sliding Panel Threshold
  - 3.4 Tri Frame - Fixed Panel Threshold
  - 3.5 Tri Frame - Sliding Panel Threshold
  - 3.6 Duo Frame - Sliding Panel Head
  - 3.7 Tri Frame - Sliding Panel Head
  - 3.8 Interlocks
    - 3.8a Standard
    - 3.8b Reinforced
  - 3.9 Meeting Section
  - 3.10 Duo Frame - Cill Options
  - 3.11 Tri Frame - Cill Options
  - 3.12 Frame Extenders & Trickle Vent

# EdgeGLIDE+ - Contents

DUAL TRACK  
APPLICABLE FOR IN-LINE SLIDING

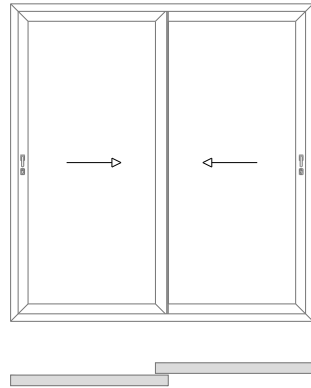

DUO RAIL  
X X

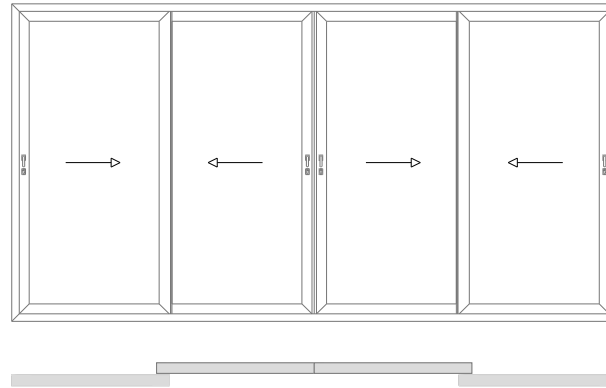

DUO RAIL  
X X X X

TRIPLE TRACK  
APPLICABLE FOR IN-LINE SLIDING

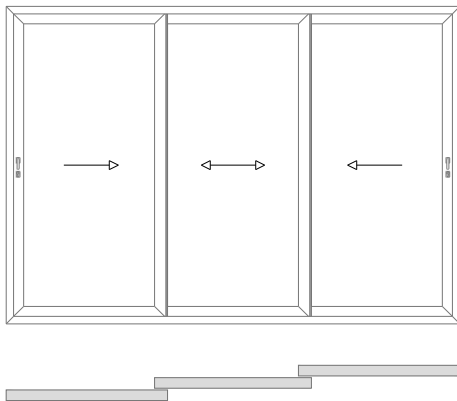

TRI RAIL  
X X X

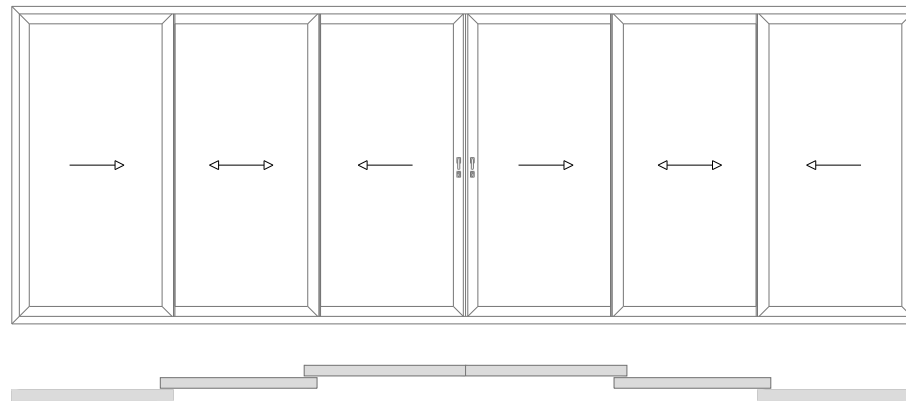

TRI RAIL  
X X X X X X

# EdgeGLIDE+ - Profiles

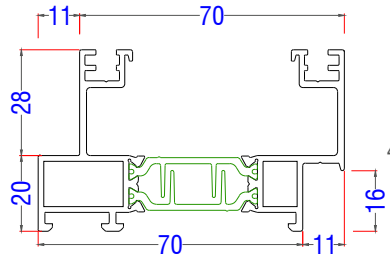

4930 - Duo Frame - Track

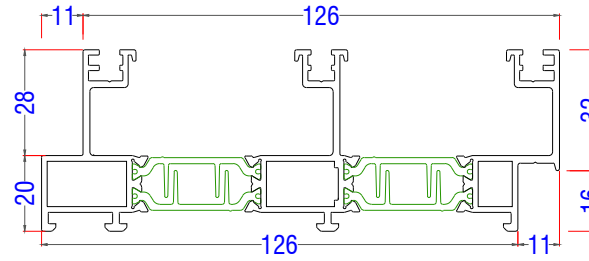

4940 - Tri Fame - Track

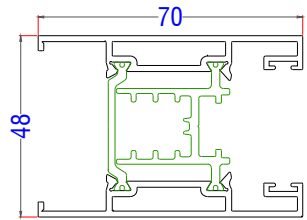

4922- Lateral Sash Profile

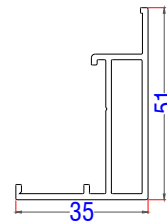

4925-01- Shallow Interlock

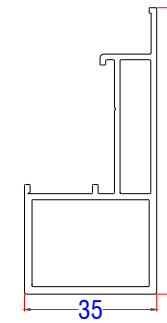

4926-01- Reinforced Interlock

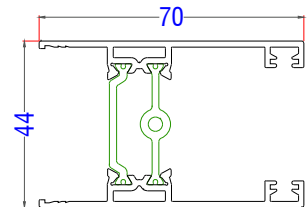

4921 - Top / Bearing Sash Profile

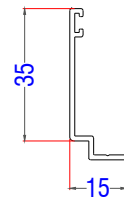

770229 - Frame Extension Add On 35mm

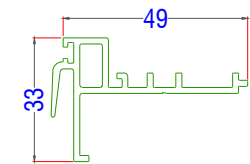

4259 - Interlock Seam Profile  
(4256)

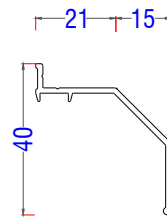

4910- Drip nose

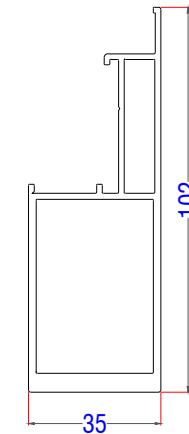

4927-01- Reinforced Interlock

# EdgeGLIDE+ - Profiles

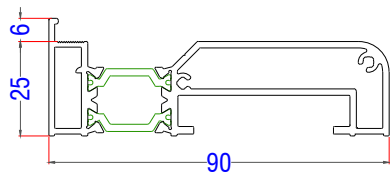

3836 - Stub Cill 90mm

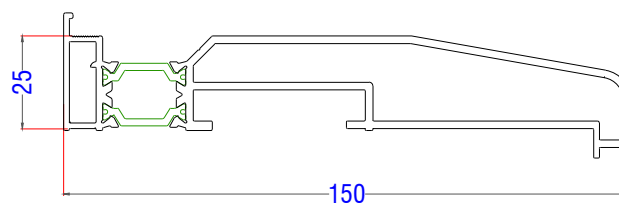

3735 - Drop Nose Cill 150mm

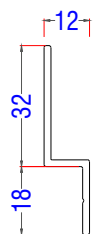

P-00-520 - Z-Profile

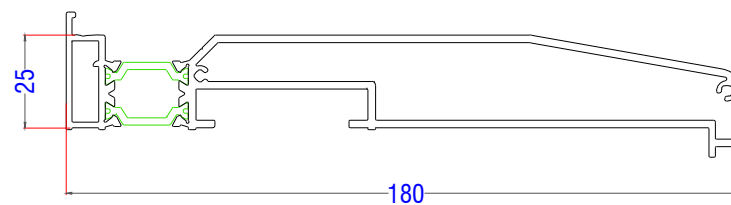

3837 - Drop Nose Cill 180mm

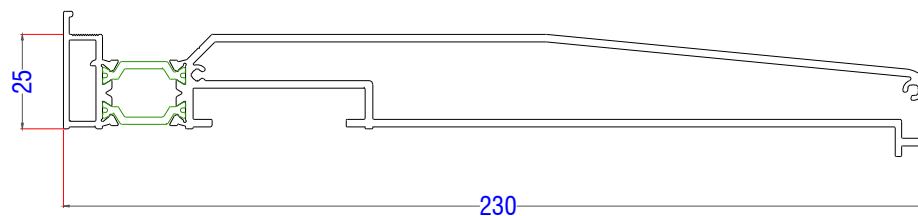

3838 - Drop Nose Cill 230mm

# EdgeGLIDE+ - Typical Sections

## Duo Frame - Locking Jamb

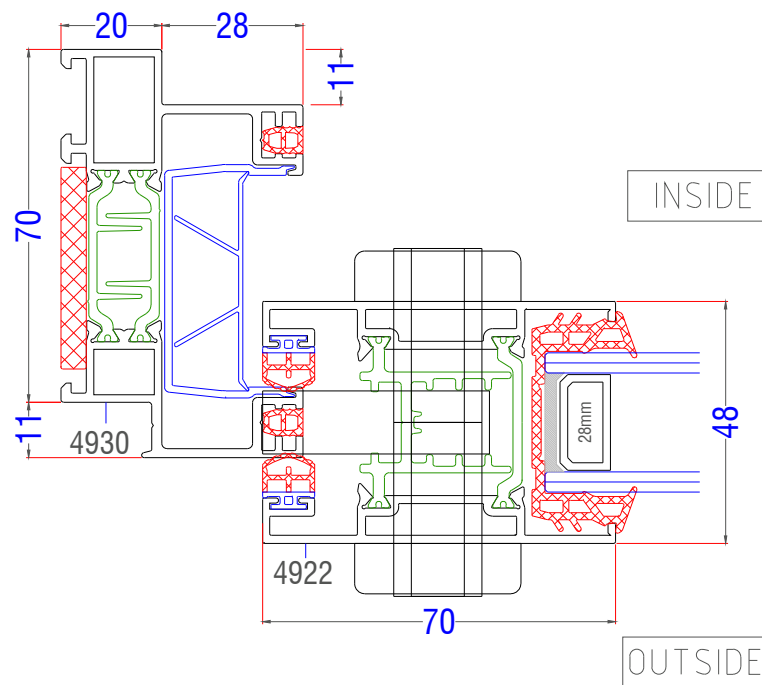
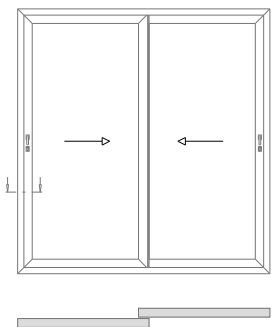

# EdgeGLIDE+ - Typical Sections

## Tri Frame - Locking Jamb

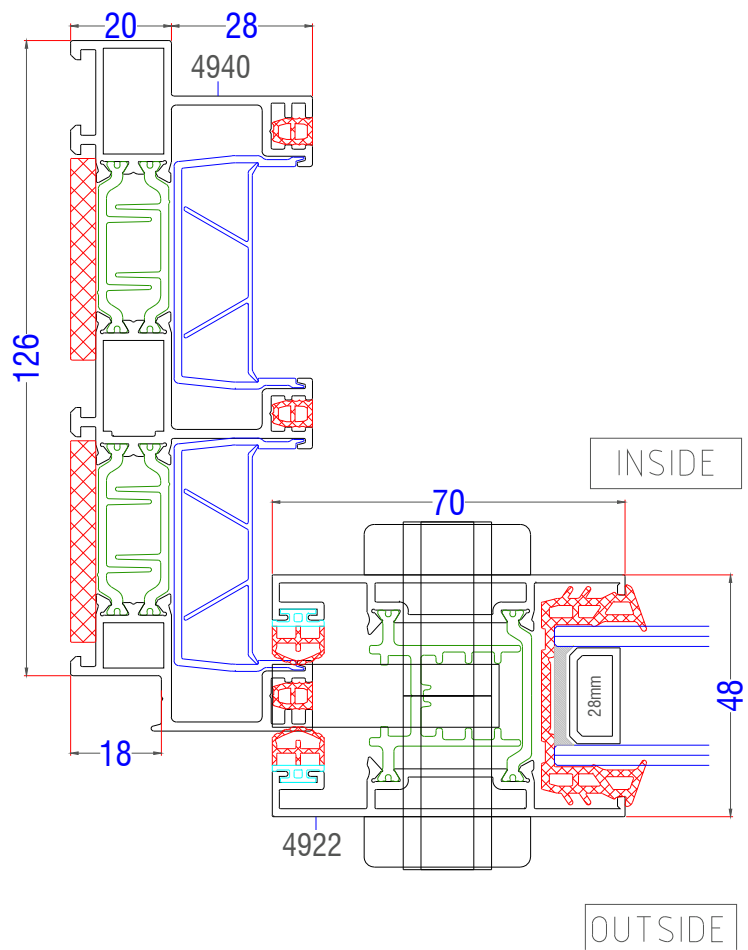
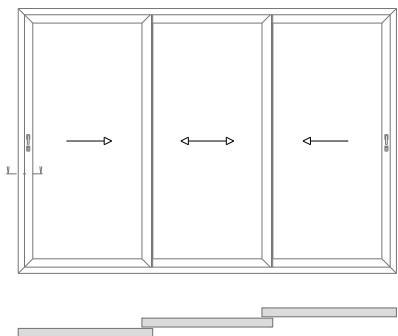



# EdgeGLIDE+ - Typical Sections

## Duo Frame - Sliding Panel Threshold

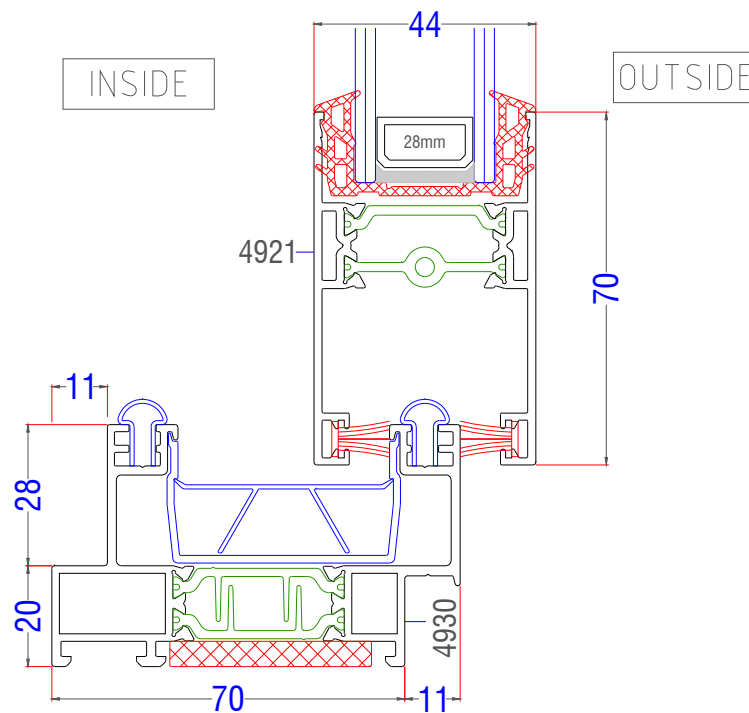
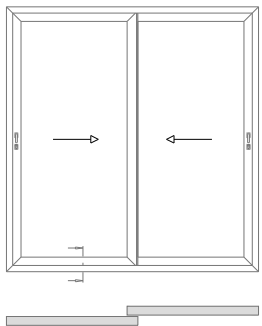

# EdgeGLIDE+ - Typical Sections

## Tri Frame - Sliding Panel Threshold

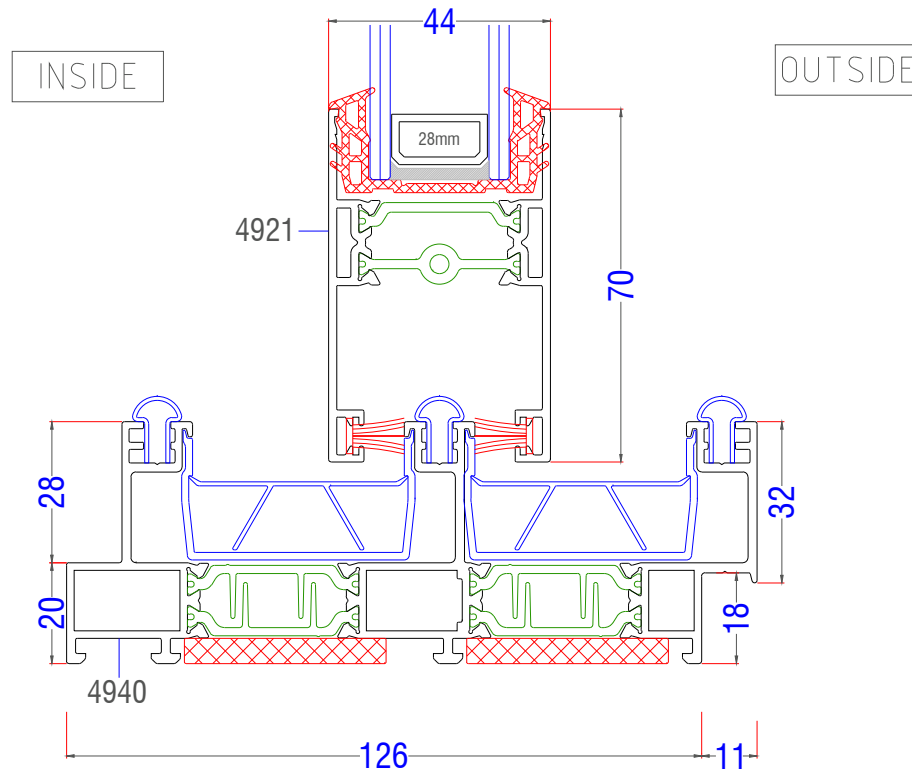
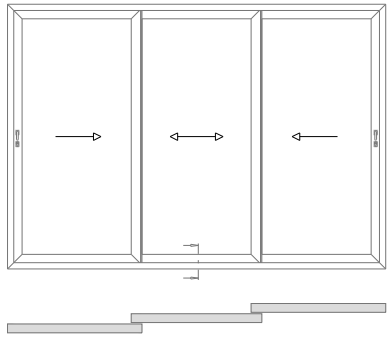

# EdgeGLIDE+ - Typical Sections

## Duo Frame - Sliding Panel Head

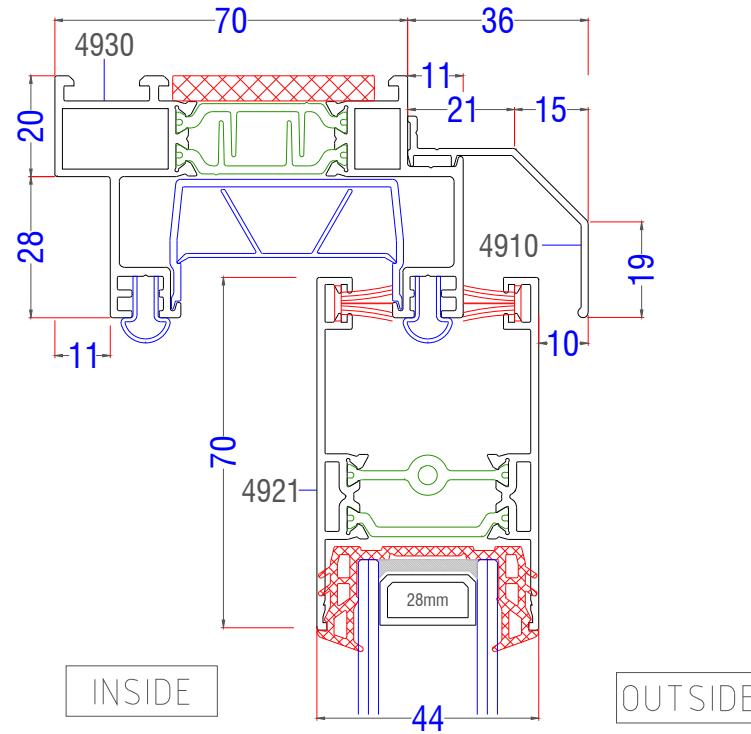
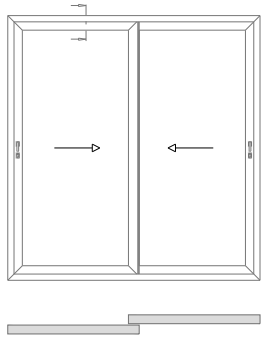

# EdgeGLIDE+ - Typical Sections

## Tri Frame - Sliding Panel Head

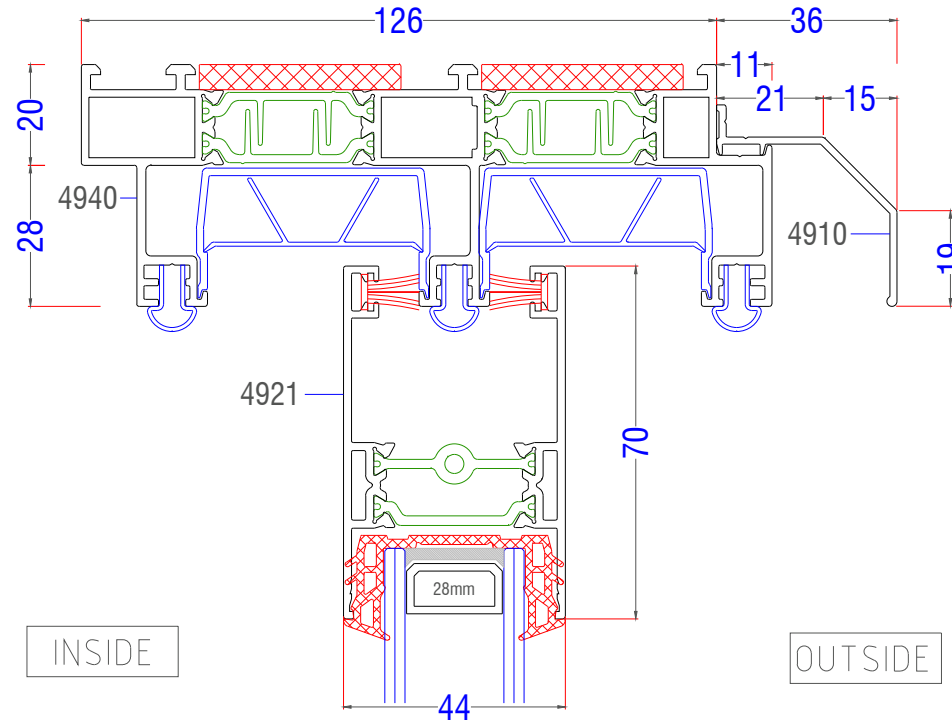
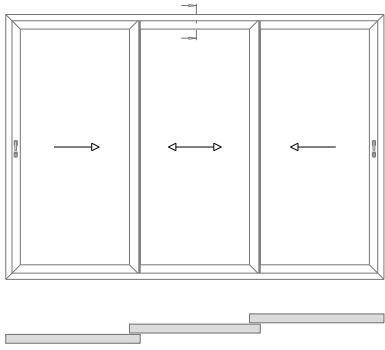

# EdgeGLIDE+ - Typical Sections

Interlock - Standard

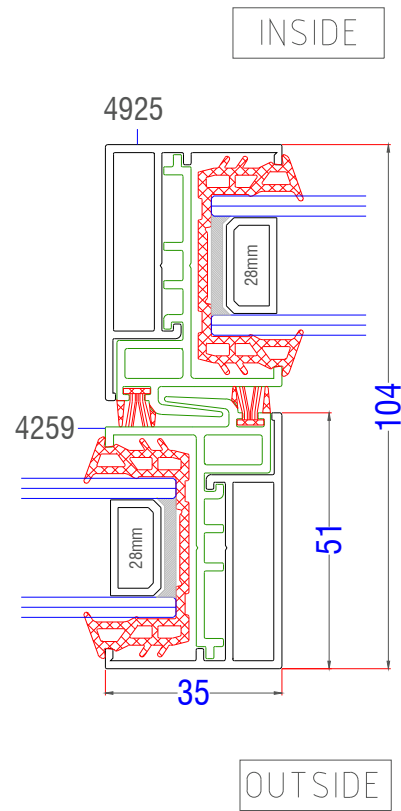
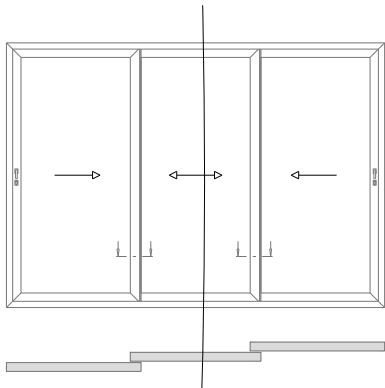
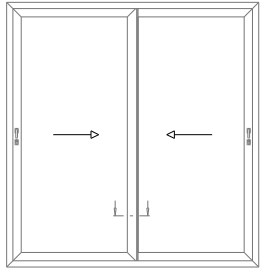

# EdgeGLIDE+ - Typical Sections

Interlock Reinforced

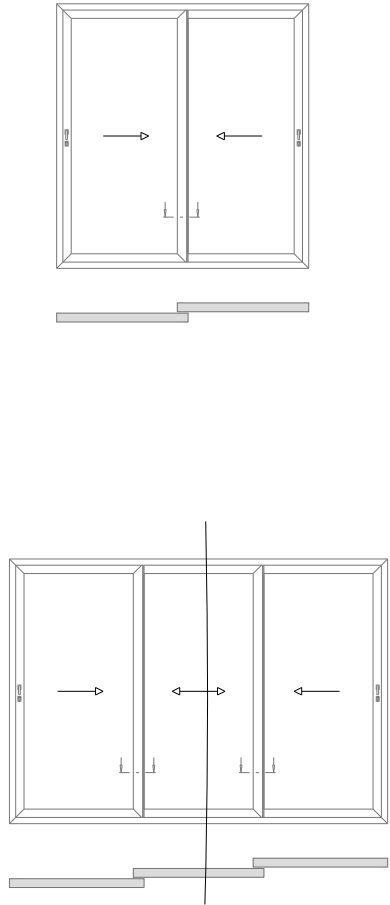

Reinforced interlock Section

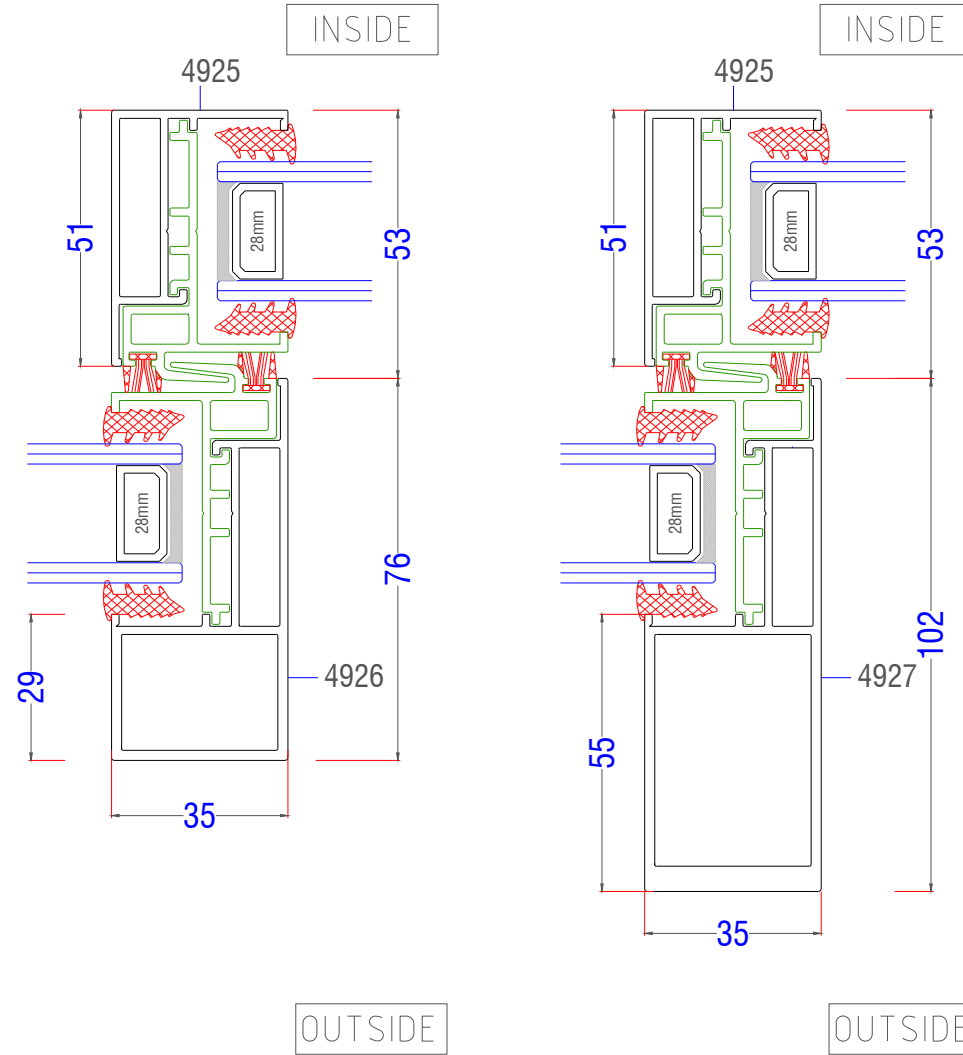

# EdgeGLIDE+ - Typical Sections

## Meeting Profile

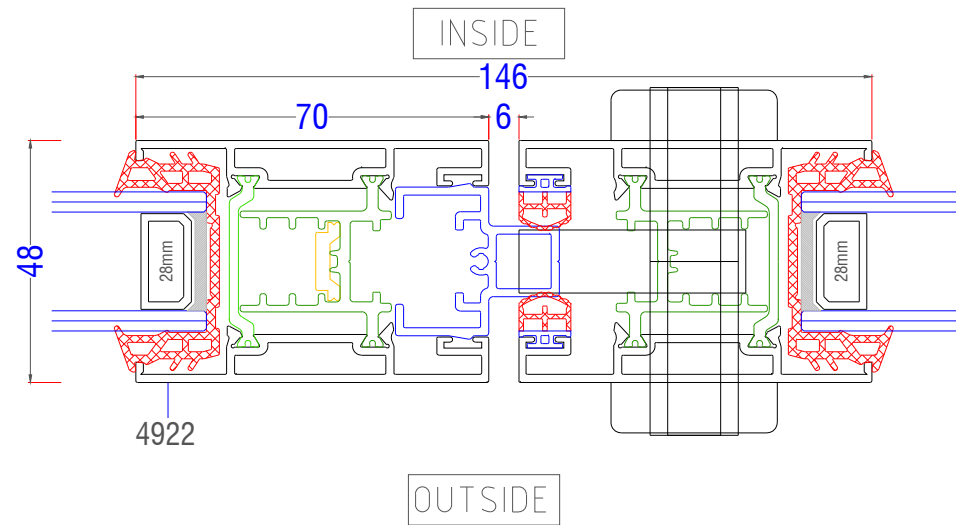
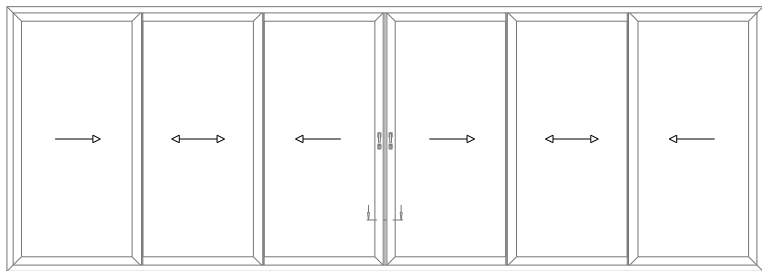
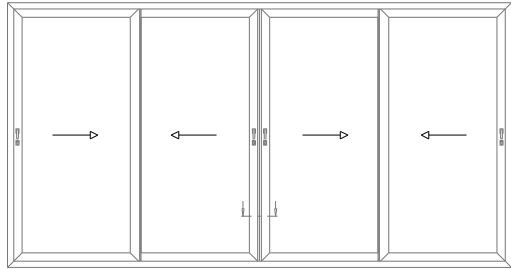

# EdgeGLIDE+ - Typical Sections

## Duo Frame - Cill Options

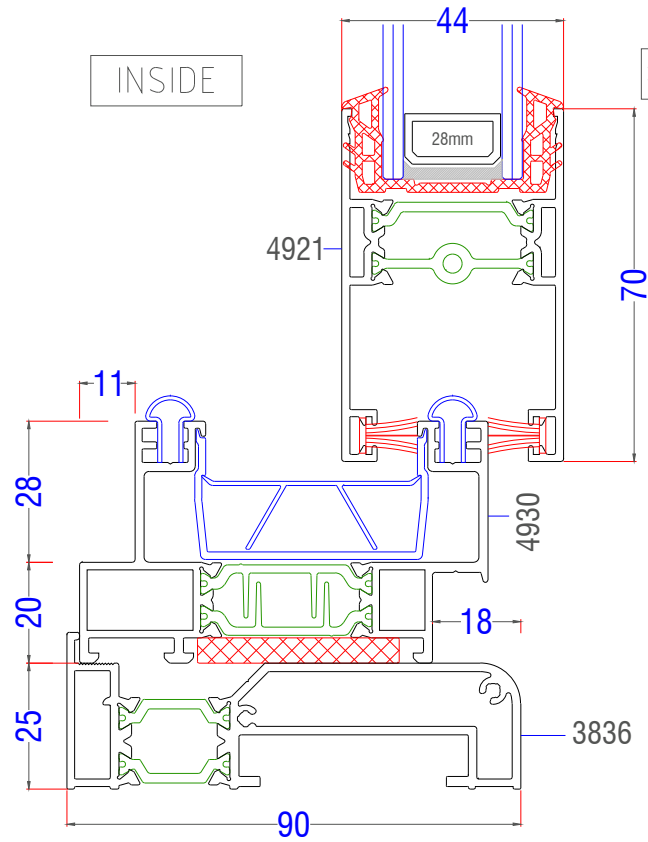
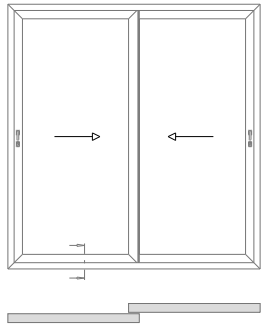

95mm stub Cill

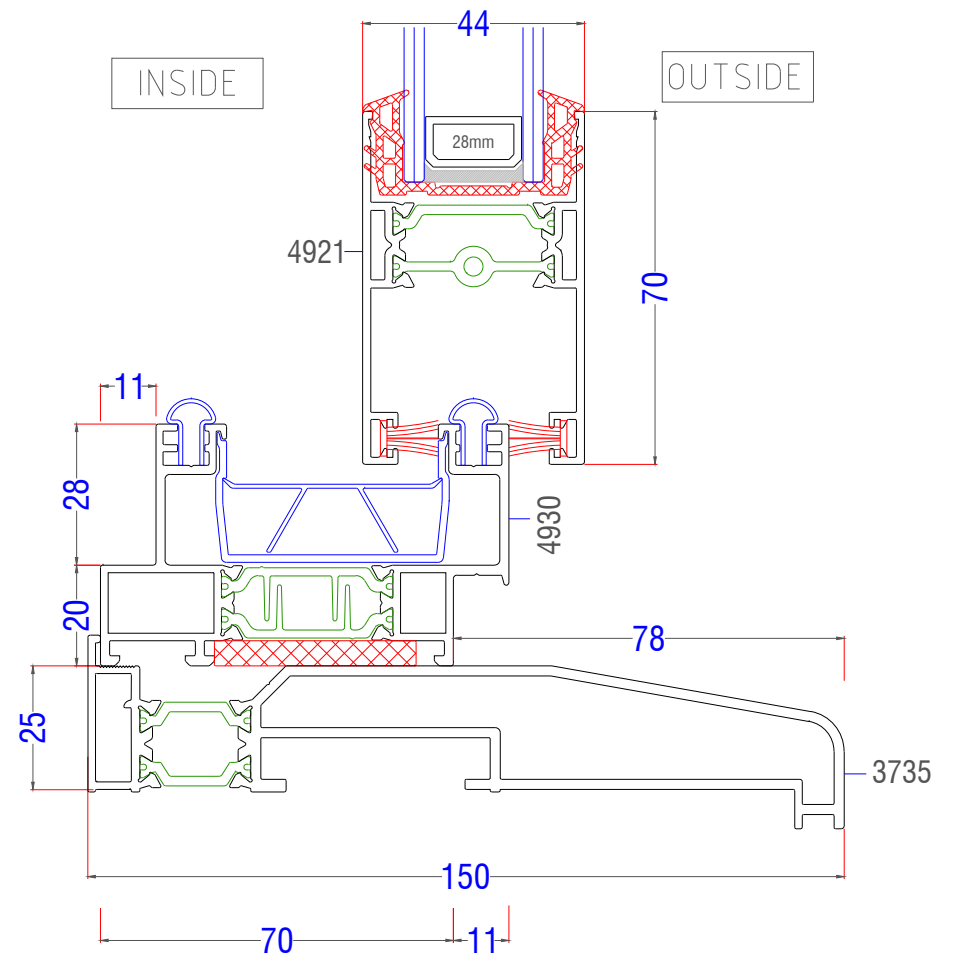

150mm Cill



# EdgeGLIDE+ - Typical Sections

## Duo Frame - Cill Options

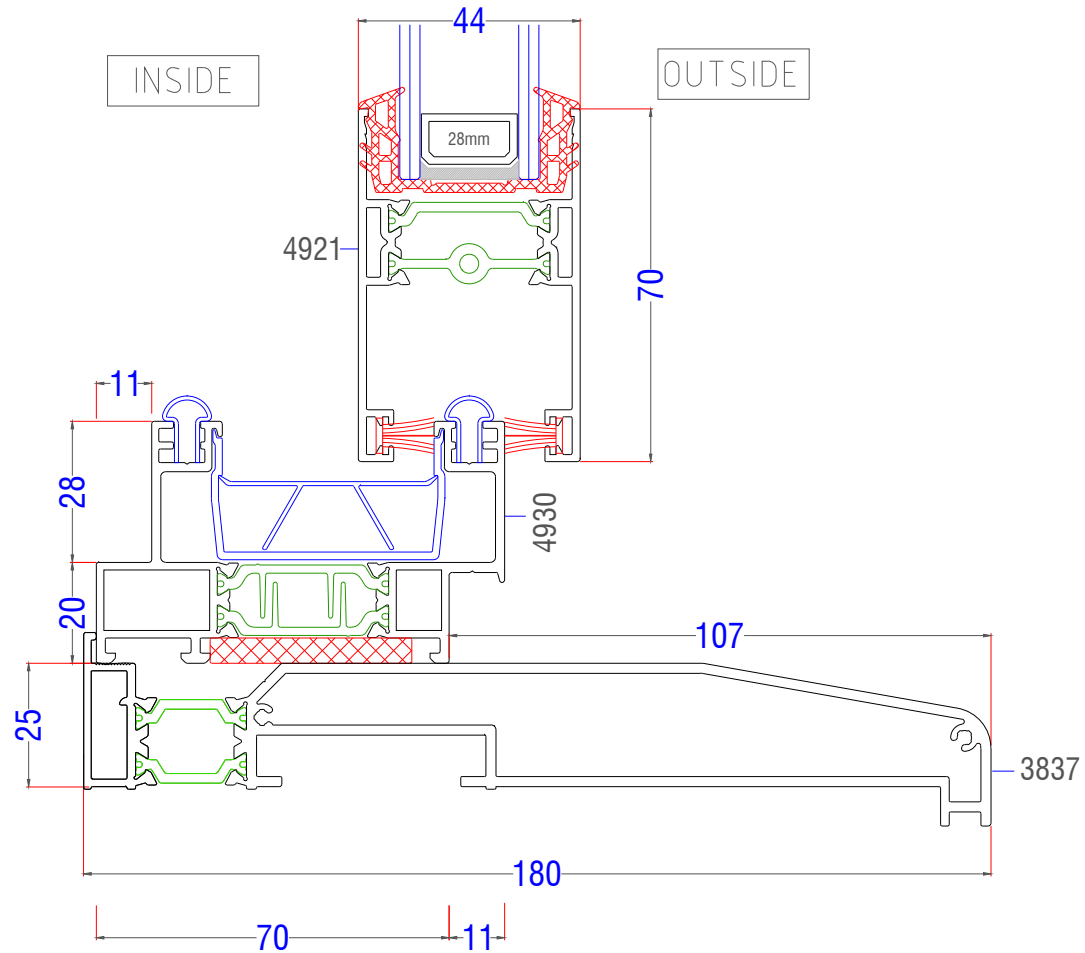
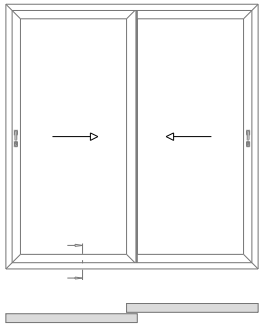

180mm Cill

# EdgeGLIDE+ - Typical Sections

Duo Frame - Level FFL detail

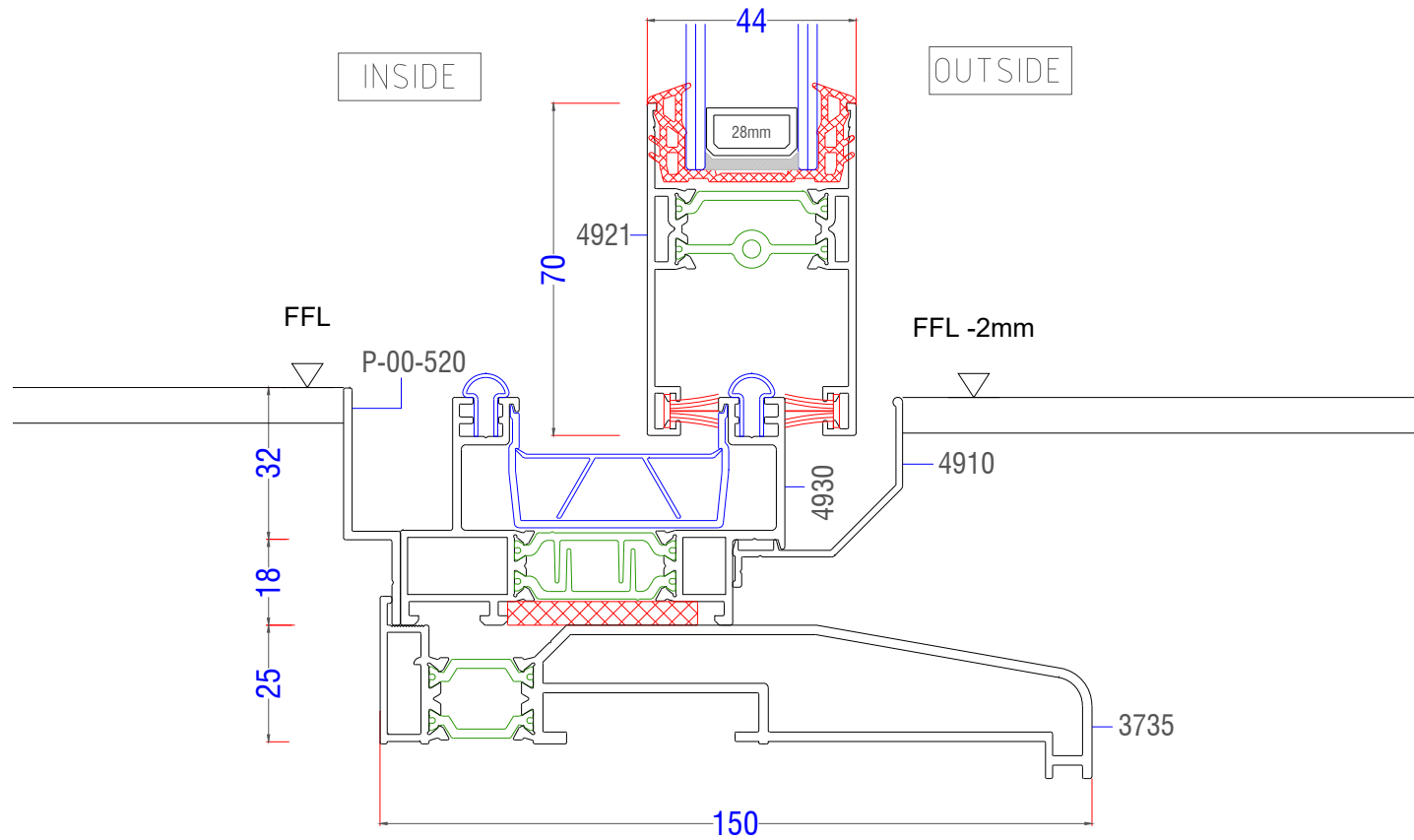
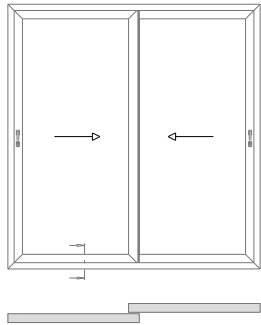

# EdgeGLIDE+ - Typical Sections

## Tri Frame - Cill Options

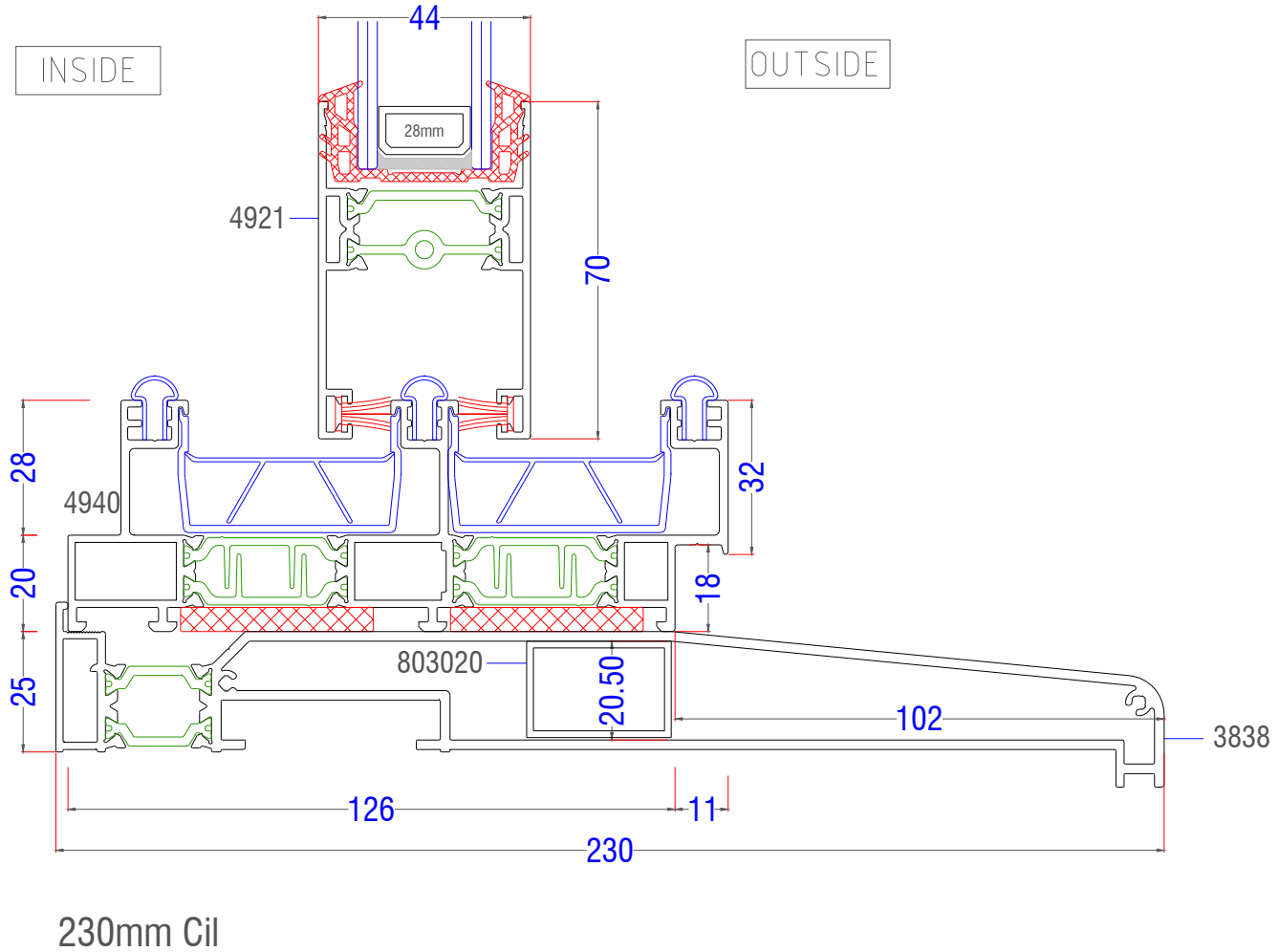
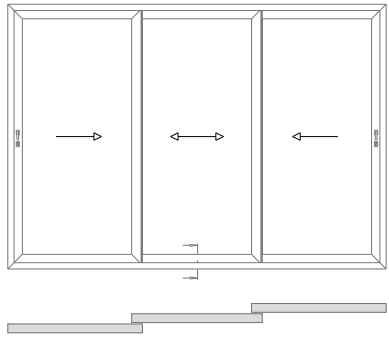

# EdgeGLIDE+ - Typical Sections

Tri Frame - Level FFI detail

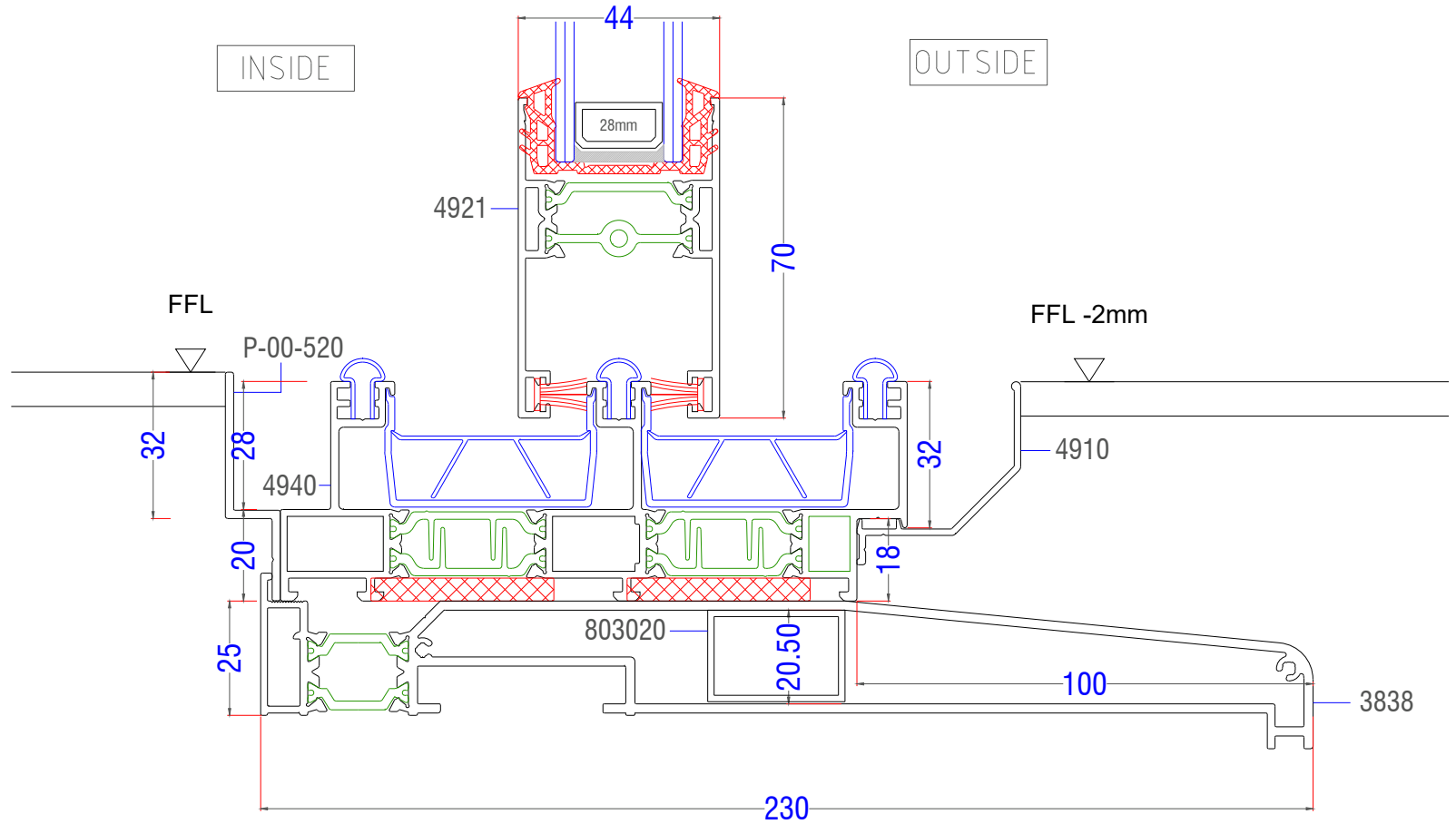
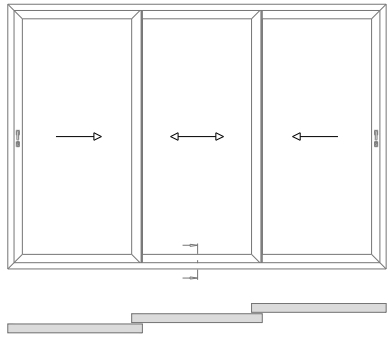

# EdgeGLIDE+ - Typical Sections

Duo Frame - Add On with Trickle Vent

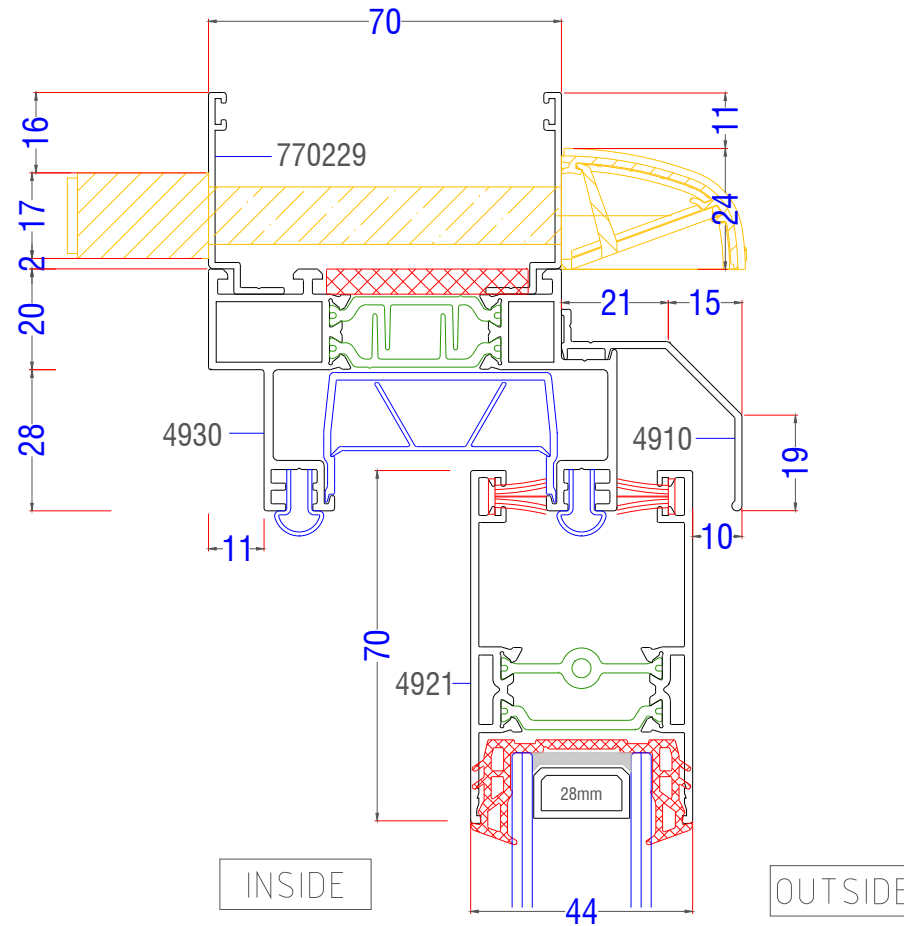
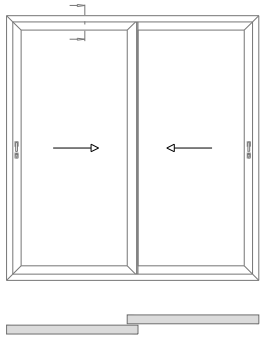

# EdgeGLIDE+ - Typical Sections

Tri Frame - Add On with Trickle Vent

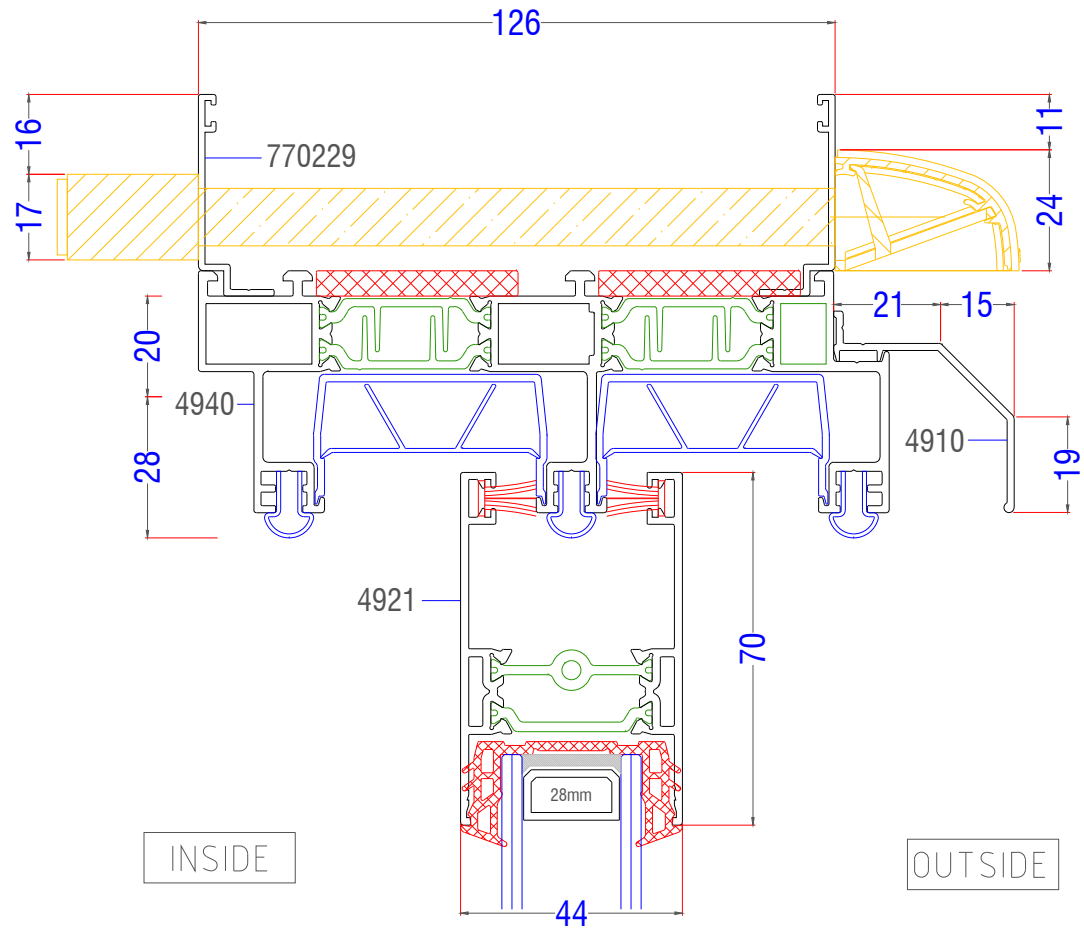
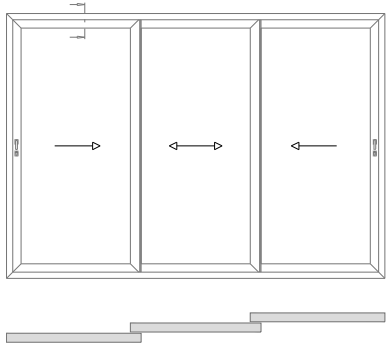





Class 6 Glazing Federation Member

Official Police Security Initiative

Arkay Windows is a specialist large-scale fabricator with over 30 years experience based in Watford, North West London.

Through growth built on putting our customers first, we have risen to supply some of the country's biggest retail companies, contractors and commercial installers.

 **Arkay Windows**

Watford: 01923 803923  
London: 020 8889 6821

[sales@arkaywindows.com](mailto:sales@arkaywindows.com)  
[www.arkaywindows.com](http://www.arkaywindows.com)

