



**Arkay Windows**

**TECHNICAL DOCUMENTS**

**Unifold**

# Unifold



**UNIFOLD**

THE EFFORTLESSLY SLIM  
NEW FOLDING SLIDING  
DOOR

*With just a 120mm, glass-to-glass sightline,*  
Unifold will open up your room to the light and  
bring the outside in, creating a functional, open  
space for living, working and entertaining.

**Slim 120mm glass-to-glass sightline**

**Fully Adjustable for ease of installation**

**Can achieve PAS 24 / Secured by design**

**Fully openable corners**

**Market beating prices**

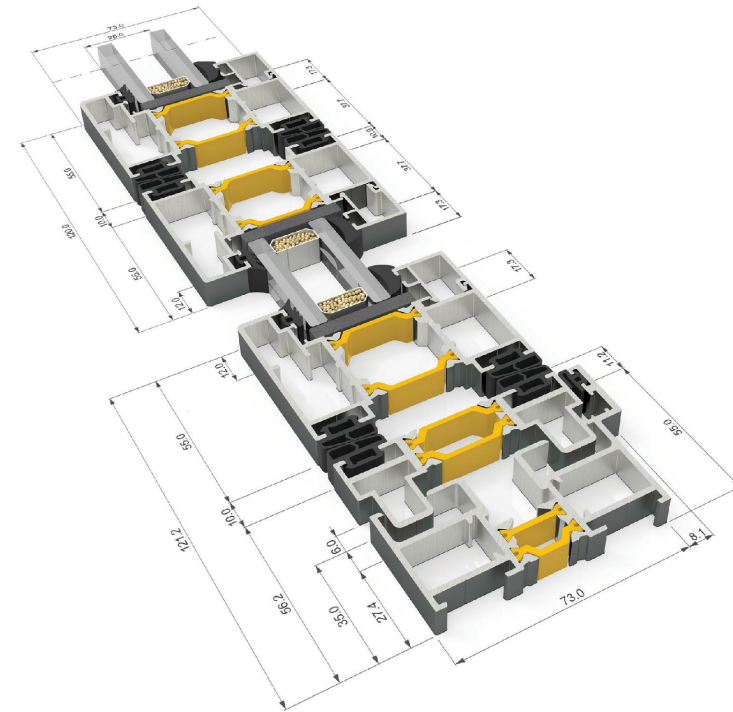

## Size Limits

Maximum panel width	1200 mm
Maximum panel height	3000 mm
Maximum panel weight	120 kg

## PERFORMANCE

U-VALUE	From 1.4 W/m <sup>2</sup> K
AIR PERMEABILITY	Class 4
WATER TIGHTNESS	Class 9A
WIND RESISTANCE	Class A3

FRAME DEPTH	73 mm
GLAZING THICKNESS	24-44 mm
GLAZING METHOD	Internally beaded
MINIMUM SIGHTLINE	120 mm
ENHANCED SECURITY	PAS24

## THRESHOLD HEIGHT

STANDARD	55 mm
DEEP	67.5 mm
LOW	40 mm
ULTRA LOW	20 mm

# UNIFOLD - Contents

- 1.0 Typical Elevations
- 2.0 Standard Profiles
- 3.0 Typical Sections
  - 3.1 Threshold - Open Out
  - 3.2 Threshold - Low Threshold
  - 3.3 Threshold - Open In
  - 3.4 Head - Open Out
  - 3.5 Head - Open In
  - 3.6 Head - Trickle Vent + 20mm Add On
  - 3.7 Jamb - Hinged Open Out
  - 3.8 Jamb - Hinged Open In
  - 3.9 Interlock - T-Handle Open Out
  - 3.10 Interlock - T-Handle Open In
  - 3.11 Meeting - Traffic to Even Open Out
  - 3.12 Jamb - Traffic Door Open Out
  - 3.13 Jamb - Traffic Door Open In
  - 3.14 Meeting - Traffic to Odd Open Out
  - 3.15 Meeting - Even to Even Open Out
  - 3.16 Jamb - Even Configuration
  - 3.17 Threshold - Cill Options
  - 3.18 Threshold Cill Nose Option

# UNIFOLD- Typical Elevations

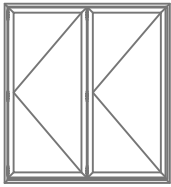

2 PANE - 220

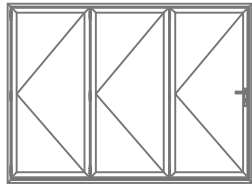

3 PANE - 330

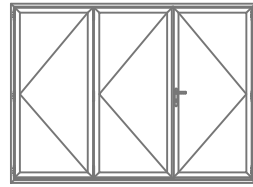

3 PANE - 321

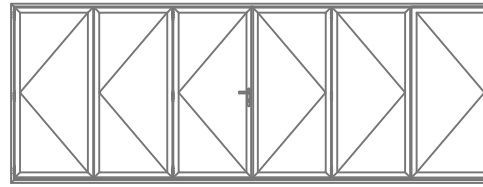

6 PANE - 633

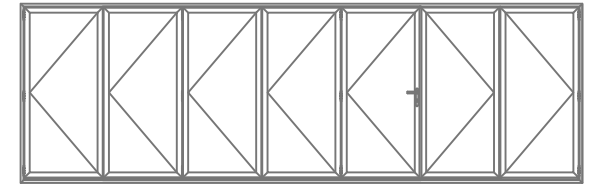

7 PANE - 752

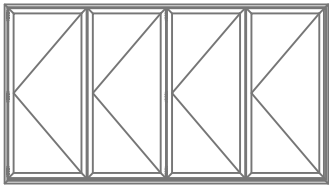

4 PANE - 440

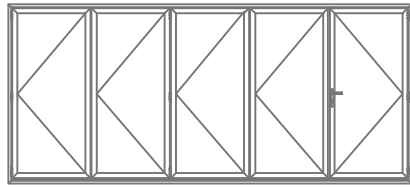

5 PANE - 541

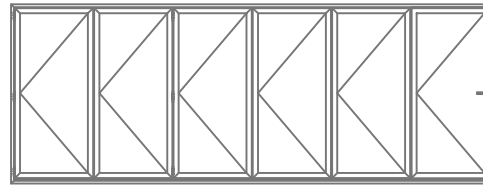

6 PANE - 660

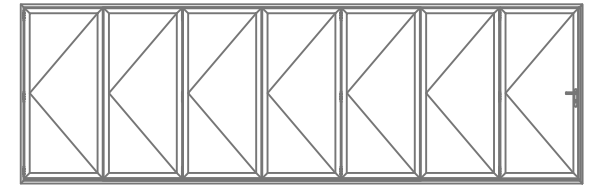

7 PANE - 770

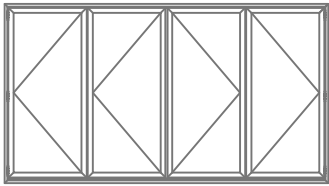

4 PANE - 422

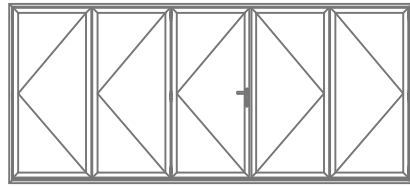

5 PANE - 532

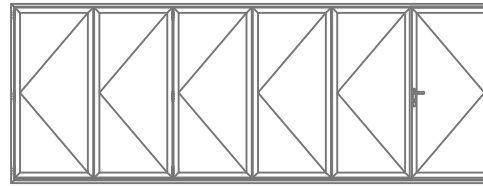

6 PANE - 651

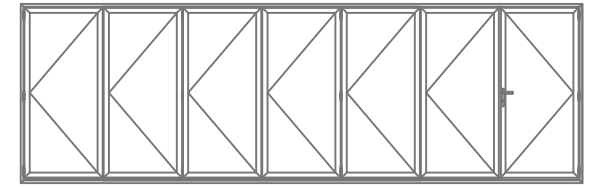

7 PANE - 761

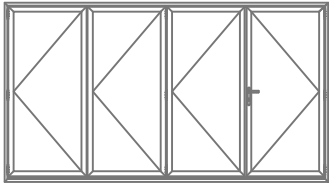

4 PANE - 431

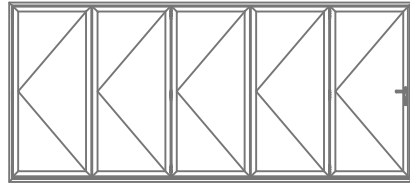

5 PANE - 550

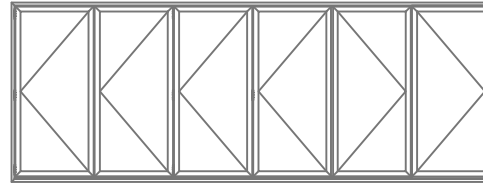

6 PANE - 642

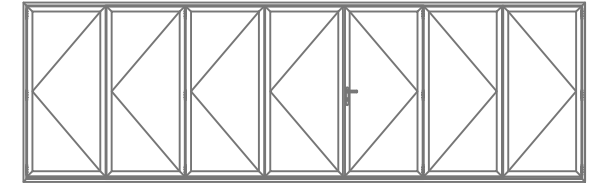

7 PANE - 743

LOW THRESHOLD OPTION AVAILABLE

OPEN IN AND OPEN OUT CONFIGURATIONS AVAILABLE

# UNIFOLD- Standard Profiles

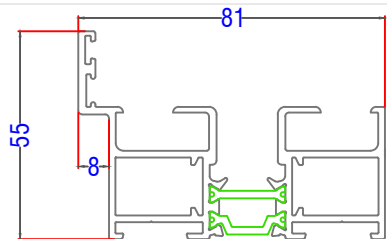

3731 - Outer Frame  
(Head and Jamb)

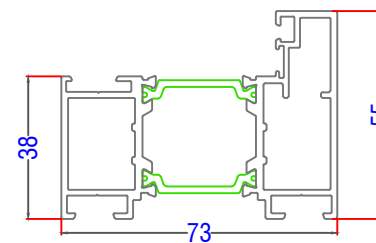

3721 - Slim Sash

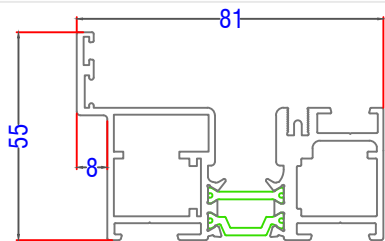

3730 - Outer Frame (Base)

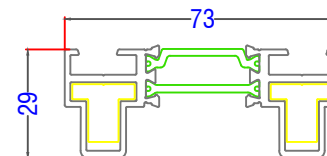

3740 - Adjustable Jamb

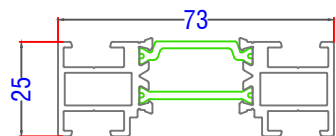

3741 - 25mm Extension Profile

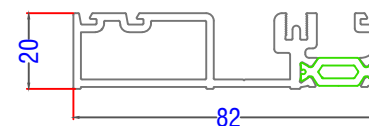

3740 - Low Threshold

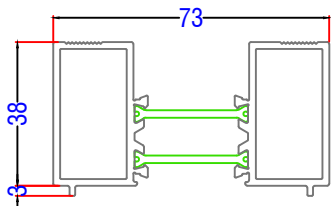

3795 - 38mm Extension Profile

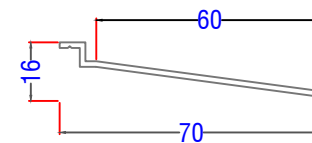

7056 - Cill Extension 70mm

# BSF 70 - Standard Profiles

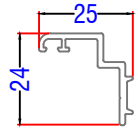

3746 - Swing Door Rebate (Adjustable Jamb)

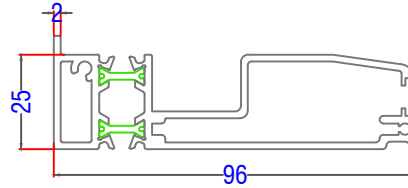

AL Uk AW570 - 95mm Stub Nose Cill

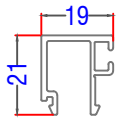

780 - 28mm DGU Glazing bead

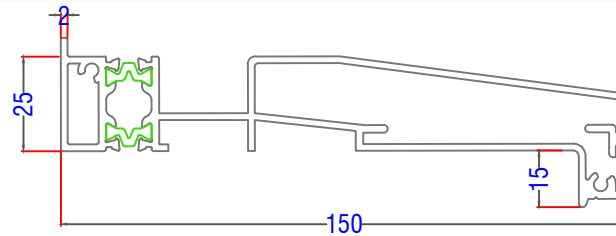

AL Uk AW542 - 150mm Drop Nose Cill

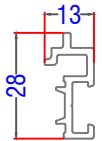

3743 - Multipoint lock add on

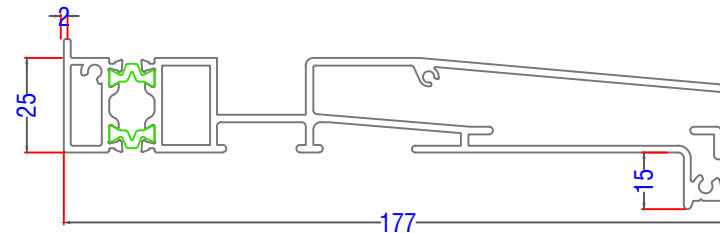

AL Uk AW543 - 177mm Drop Nose Cill

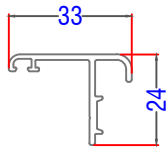

3745 - Swing Door Rebate

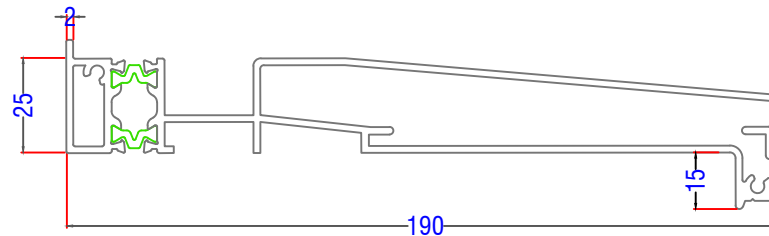

AL Uk AW544 - 190mm Drop Nose Cill

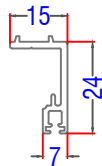

3725 - Sash Extension

# UNIFOLD - Typical Sections

Threshold - Open Out

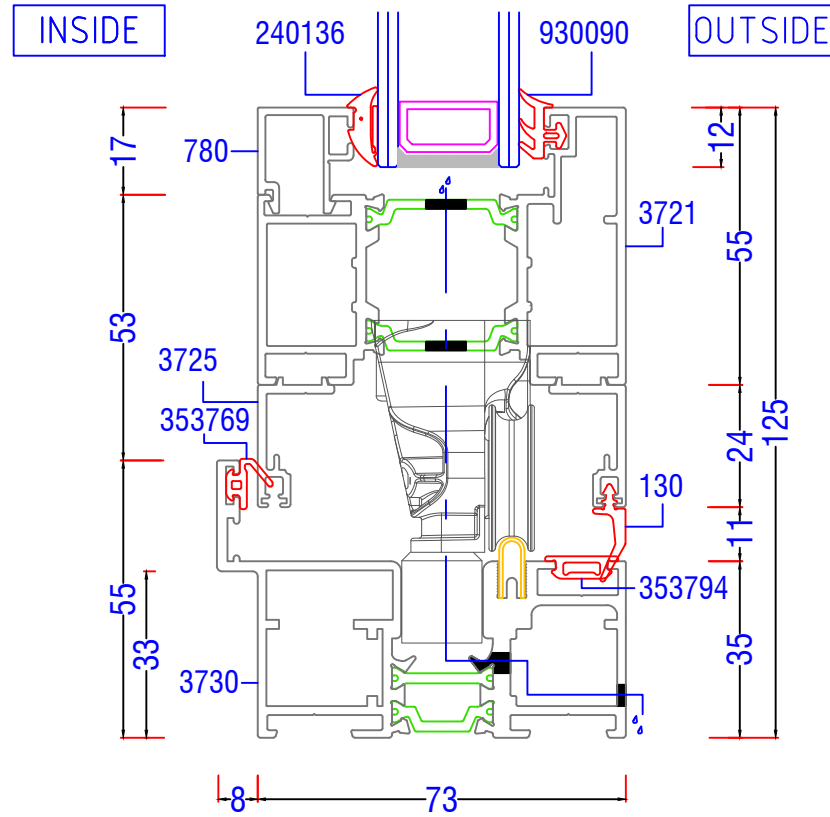
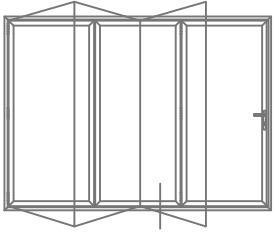

# UNIFOLD - Typical Sections

Threshold - Low Threshold

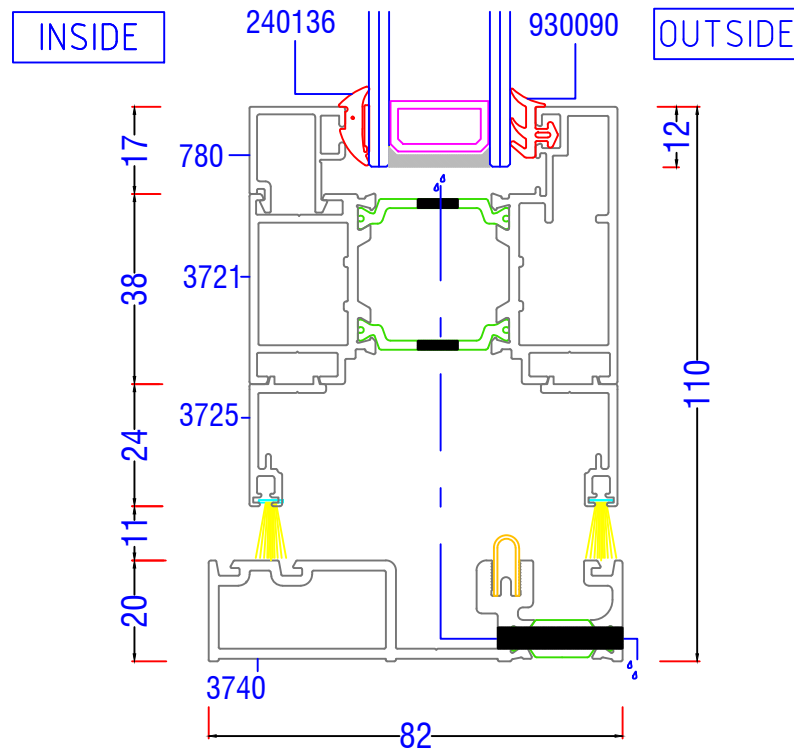
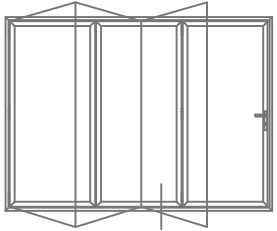



# UNIFOLD - Typical Sections

Threshold - Open In

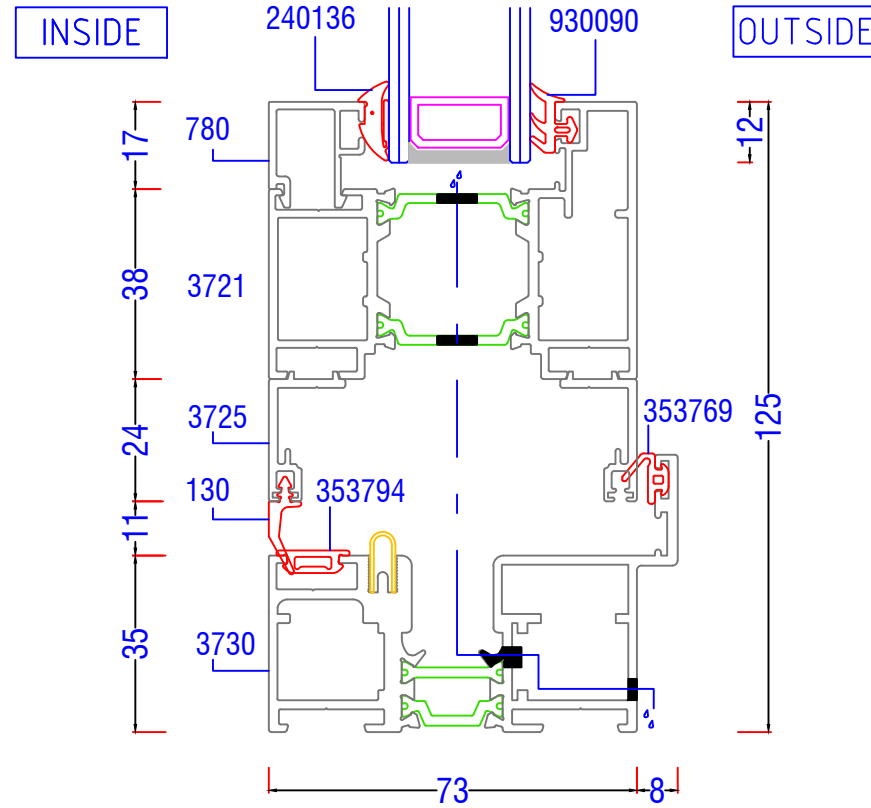
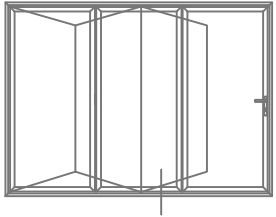

# UNIFOLD - Typical Sections

Head - Open Out

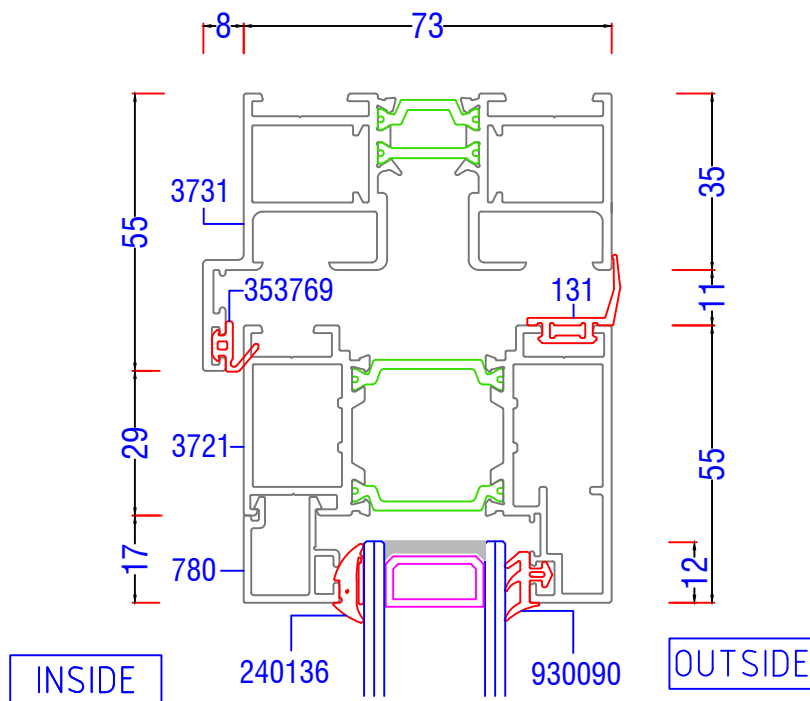
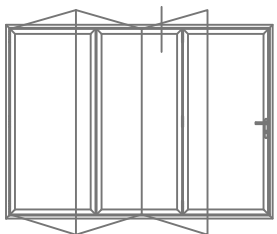

# UNIFOLD - Typical Sections

Head - Open In

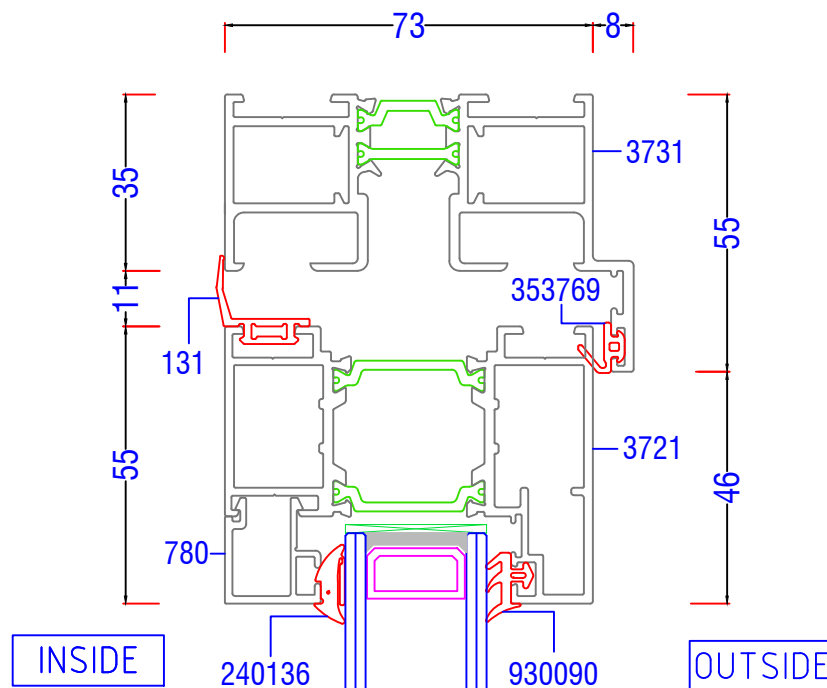
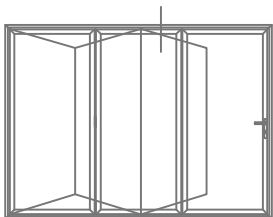

# UNIFOLD - Typical Sections

Head - Open In with 20mm Extension + Trickle Vent

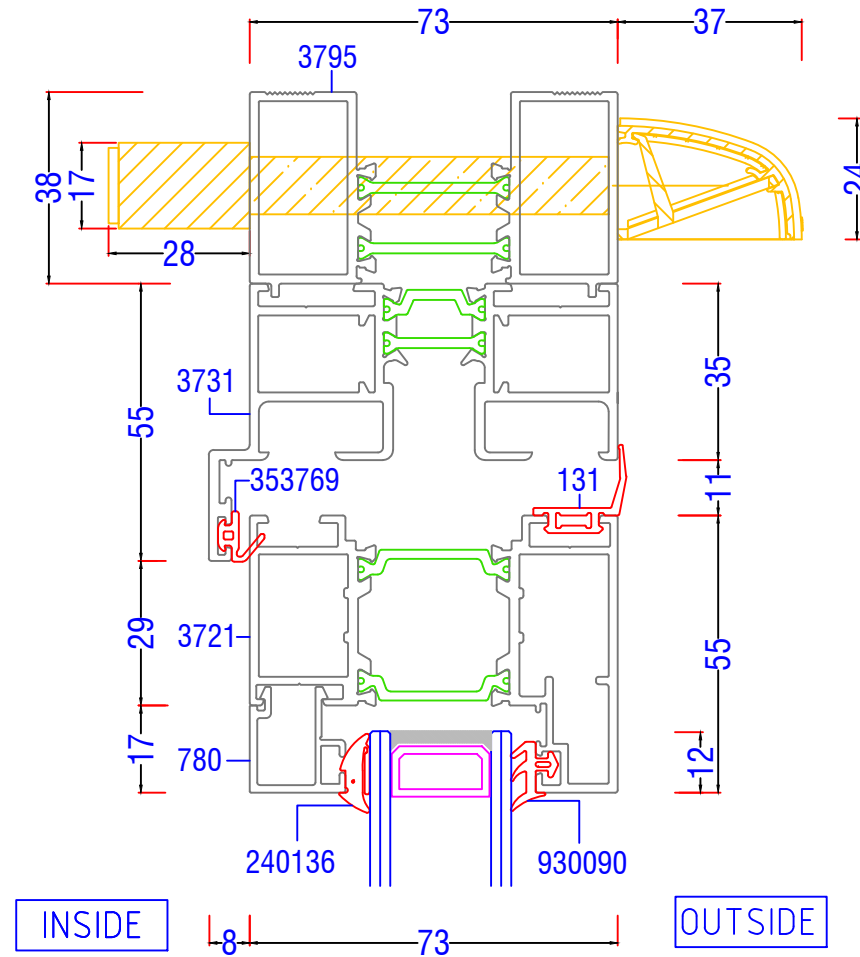
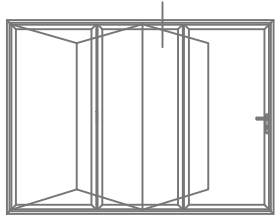

# UNIFOLD - Typical Sections

Jamb - Hinged Open Out

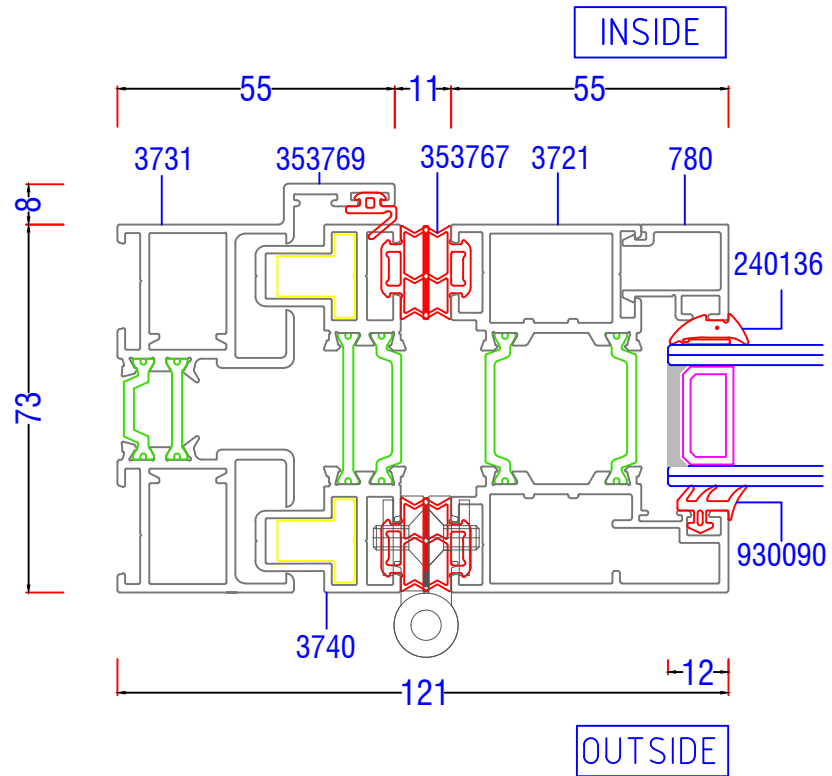
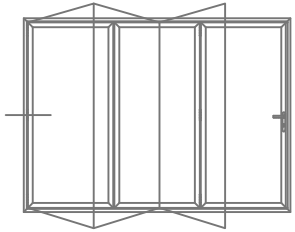

# UNIFOLD - Typical Sections

Jamb - Hinged Open In

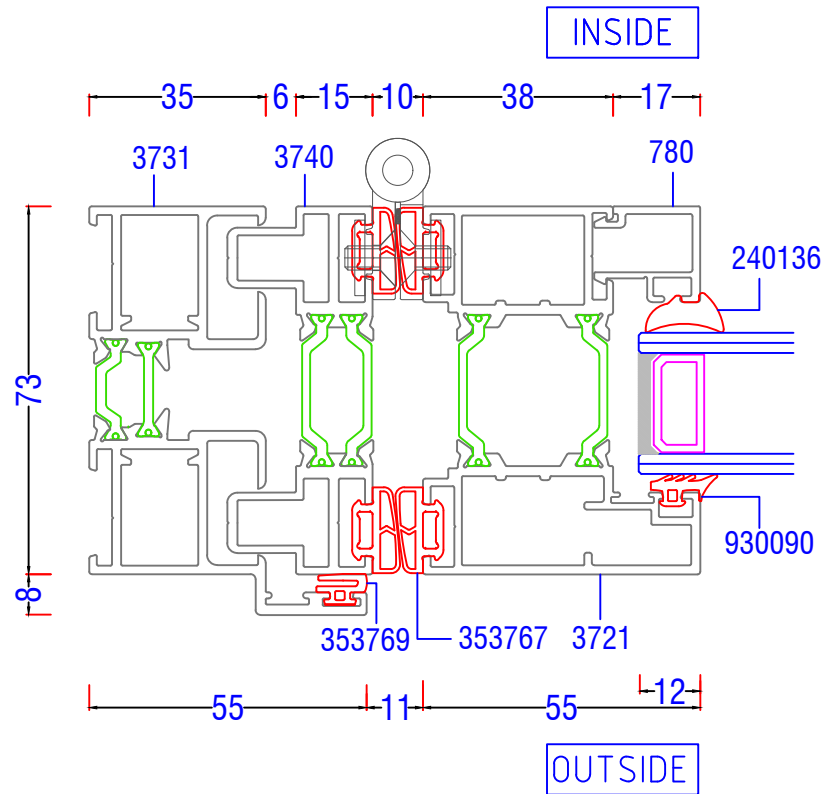
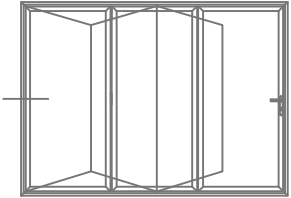

# UNIFOLD - Typical Sections

Interlock - T-Handle Open Out

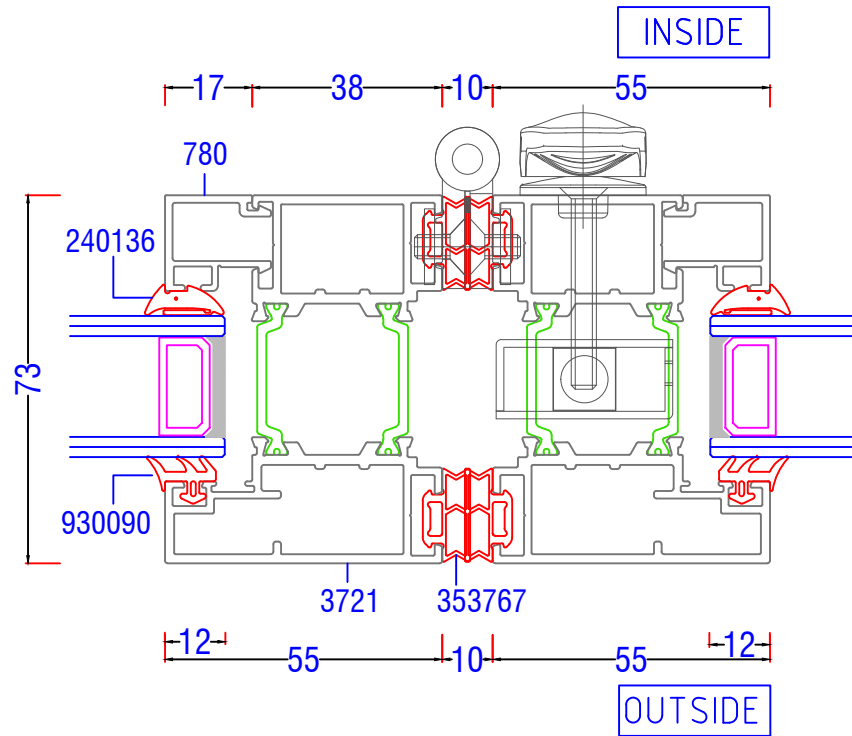
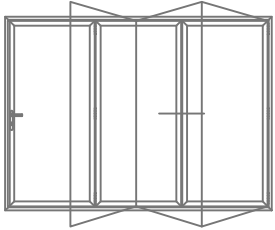

# UNIFOLD- Typical Sections

Interlock - T-Handle Open In

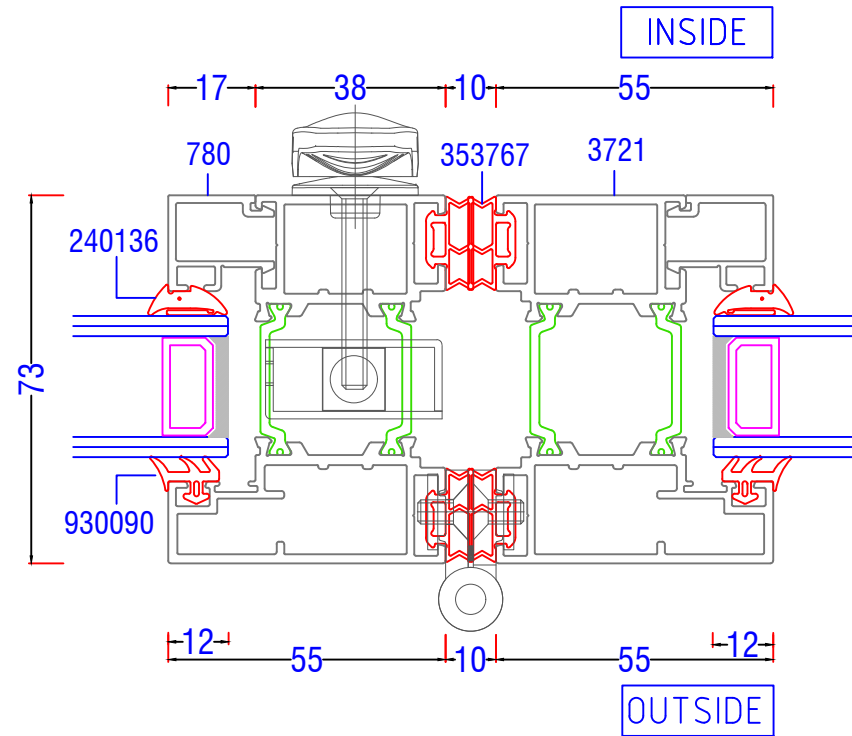
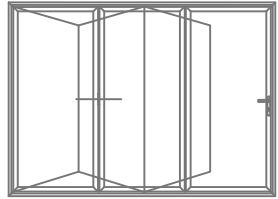



# UNIFOLD - Typical Sections

Meeting - Traffic To Even Open Out

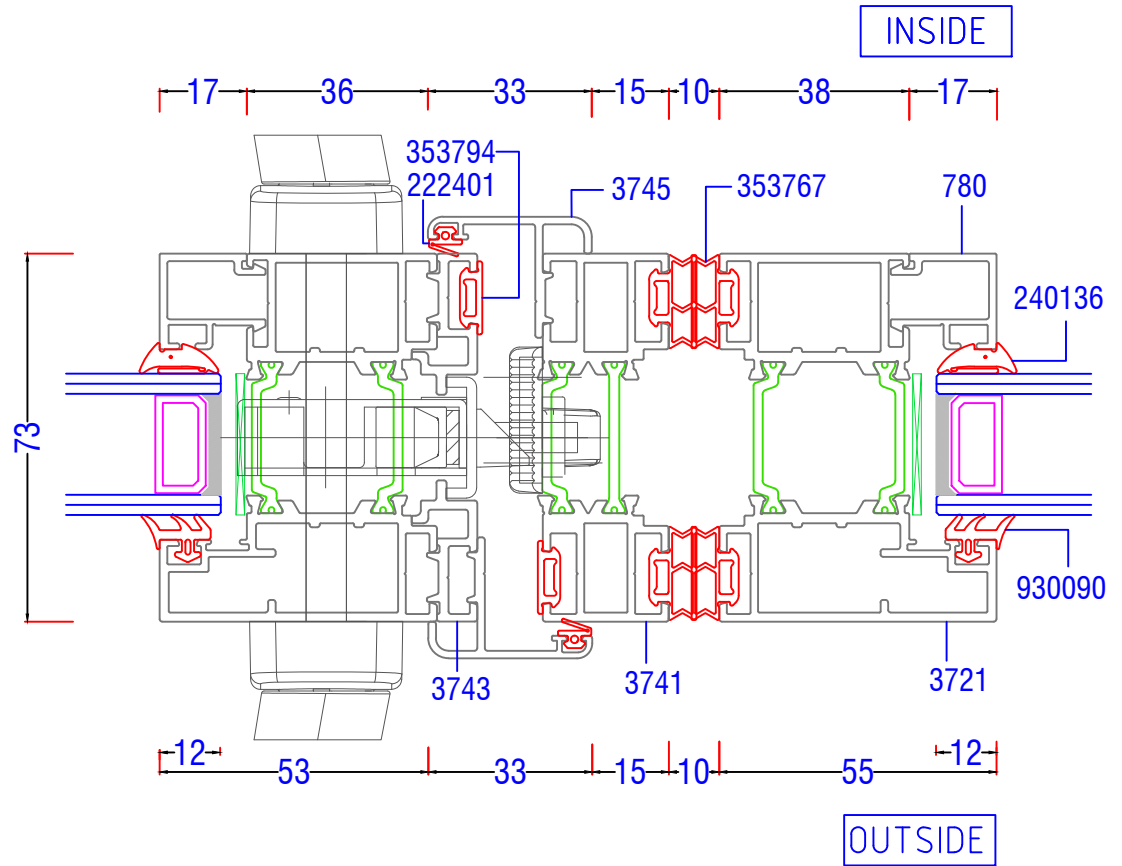
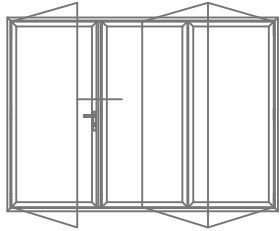

# UNIFOLD - Typical Sections

## Jamb - Traffic Door Open Out

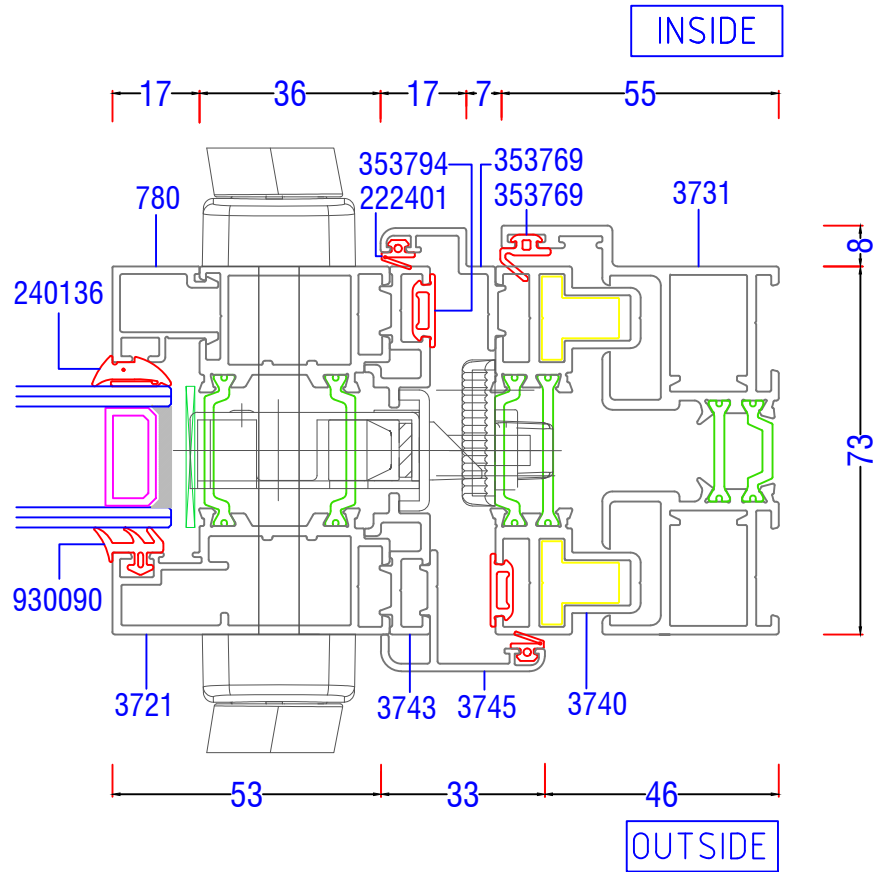
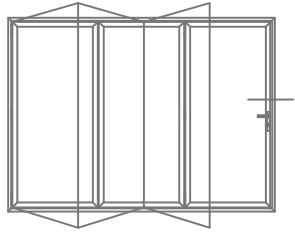

# UNIFOLD - Typical Sections

Jamb - Traffic Door Open In

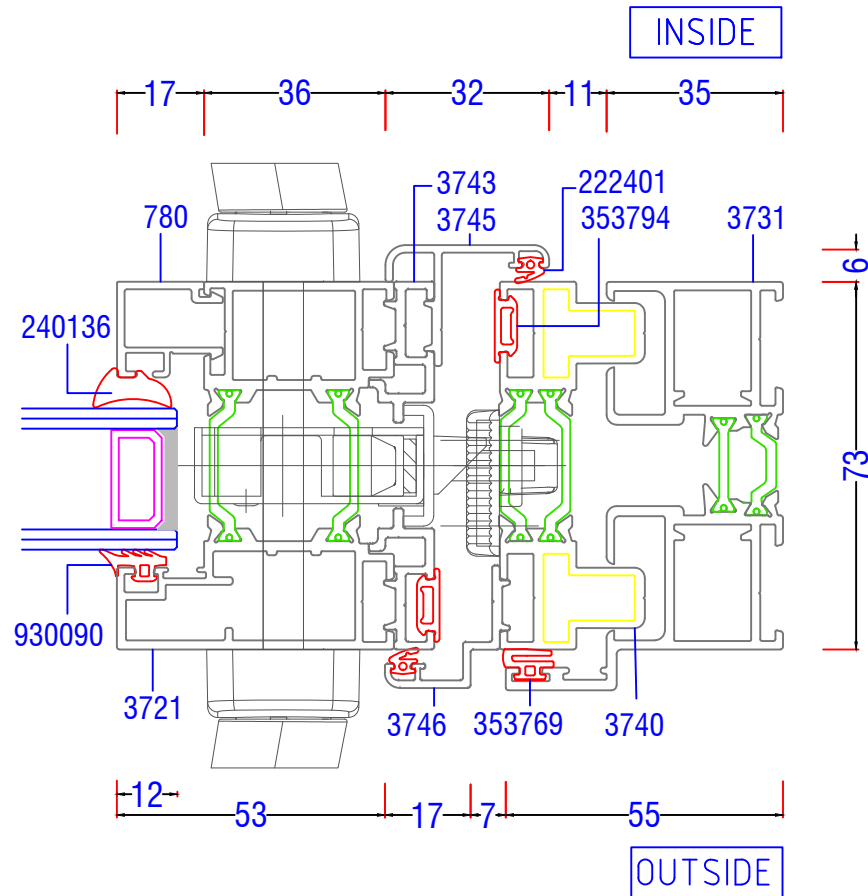
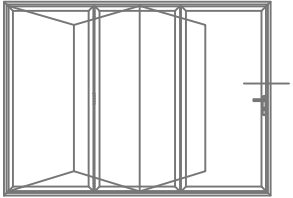

# UNIFOLD - Typical Sections

Meeting - Traffic To Odd Open Out

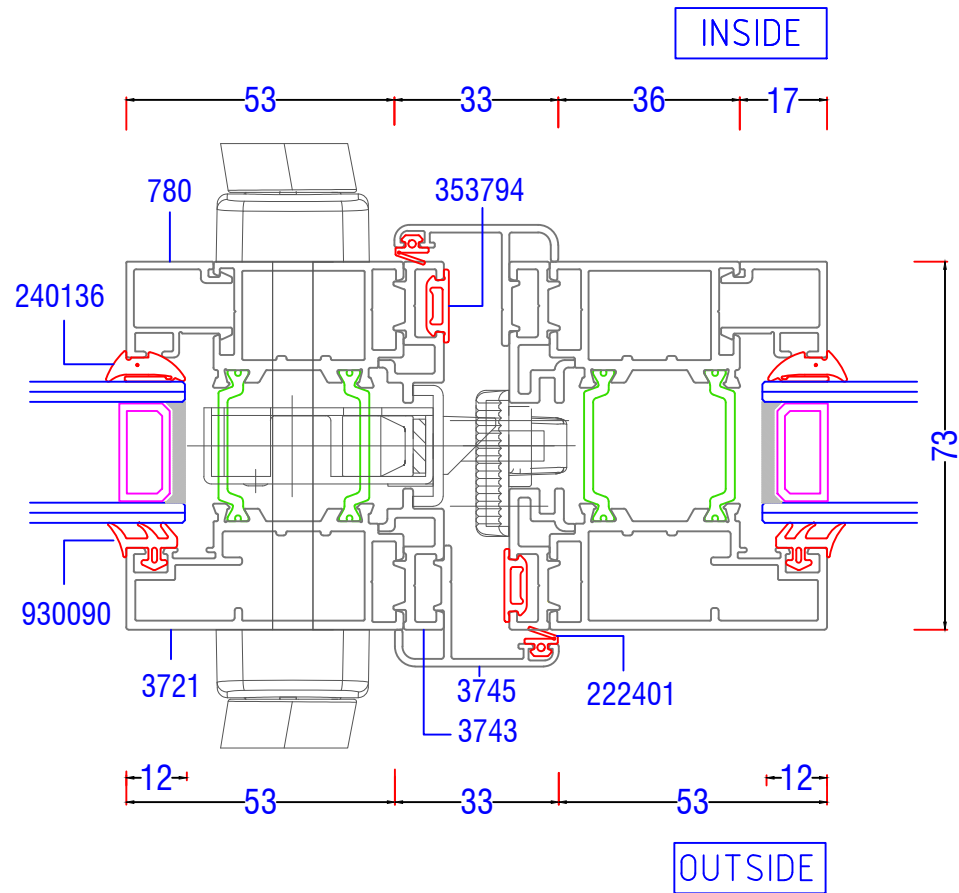
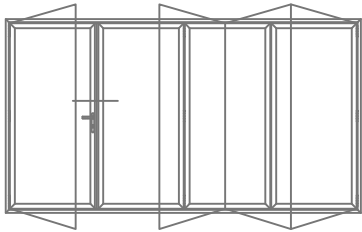

# UNIFOLD - Typical Sections

Meeting - EvenTo Even Open Out - No Traffic Door

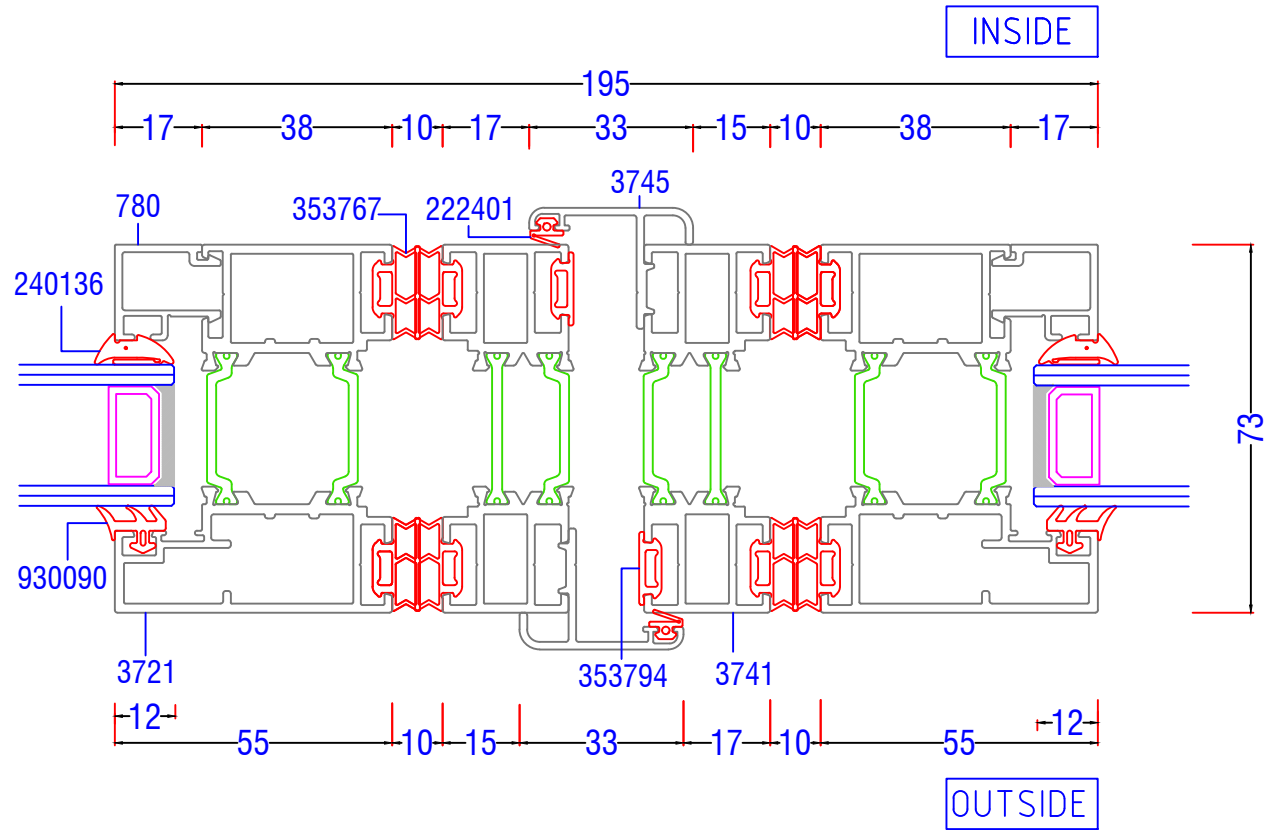
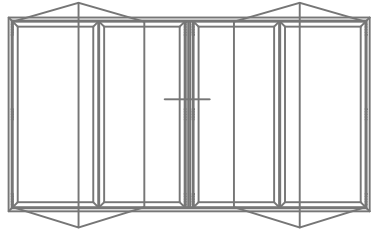

# UNIFOLD - Typical Sections

Jamb - Even Configuration - No Traffic Door

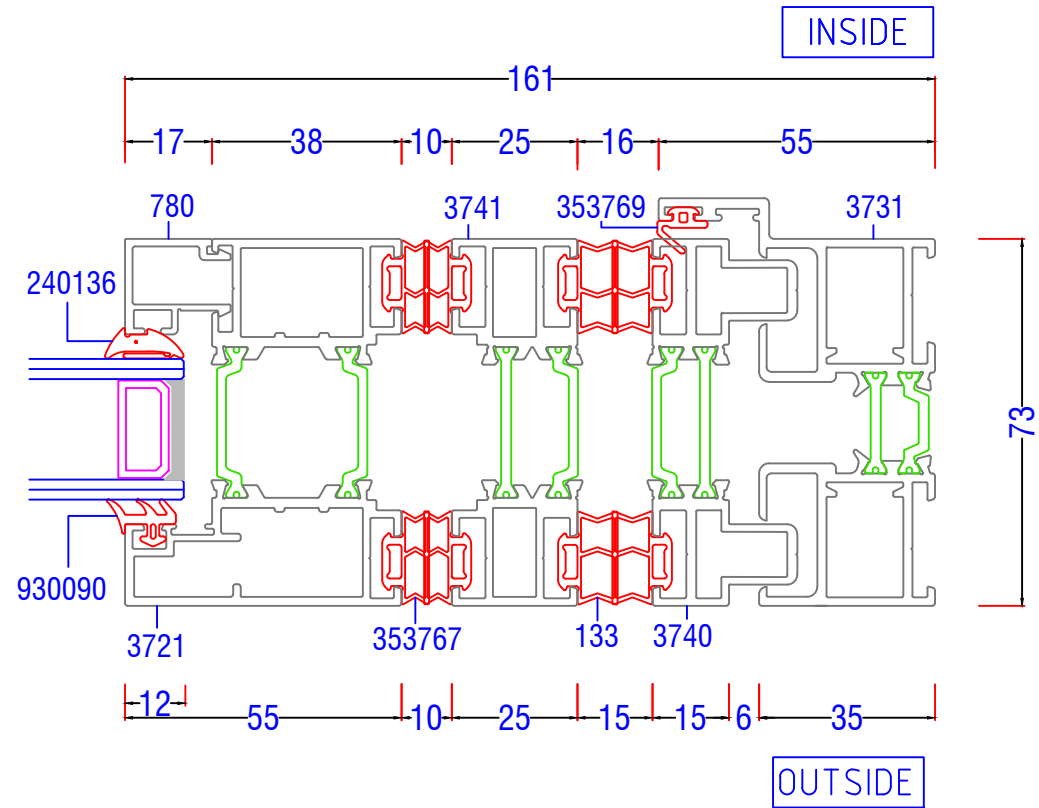
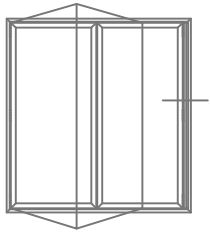

# UNIFOLD - Typical Sections

## Threshold - Cill Options

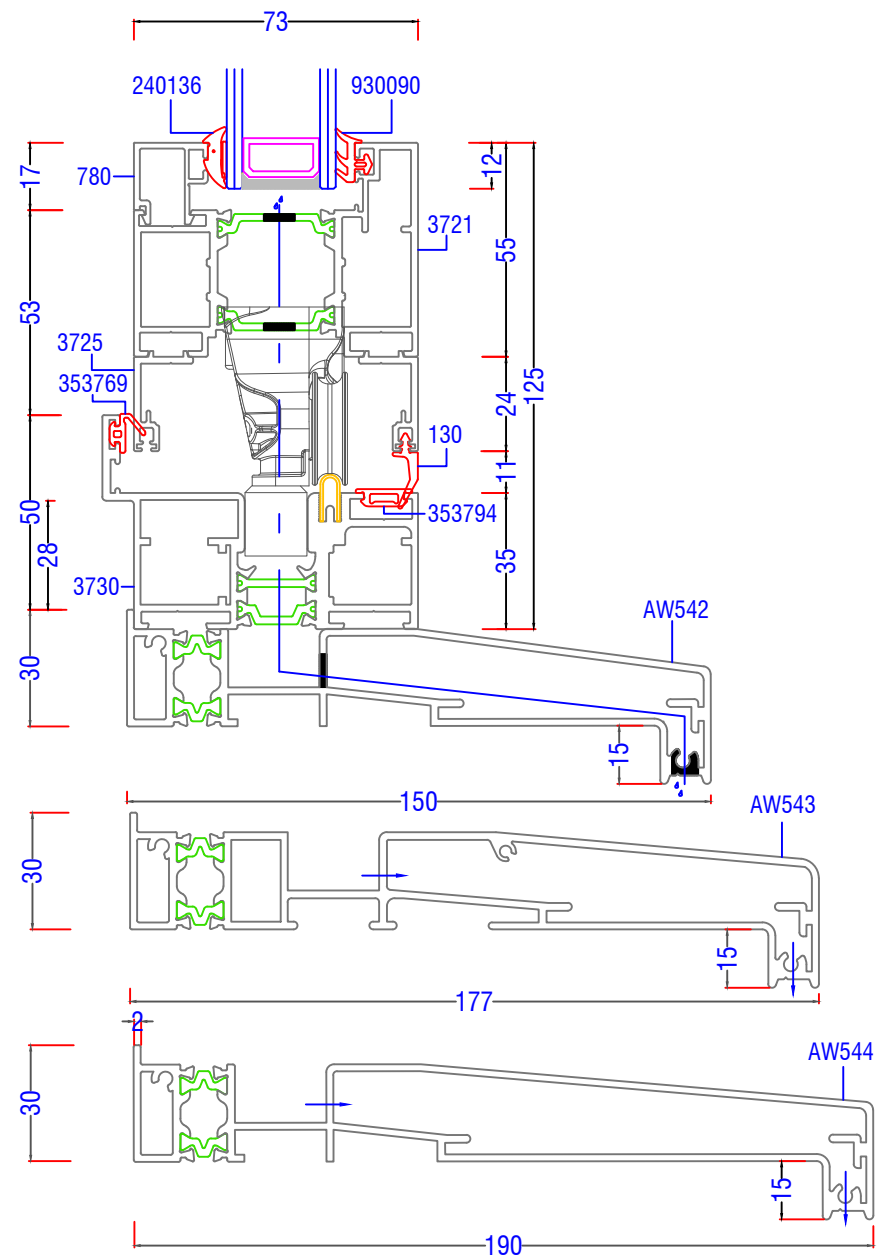
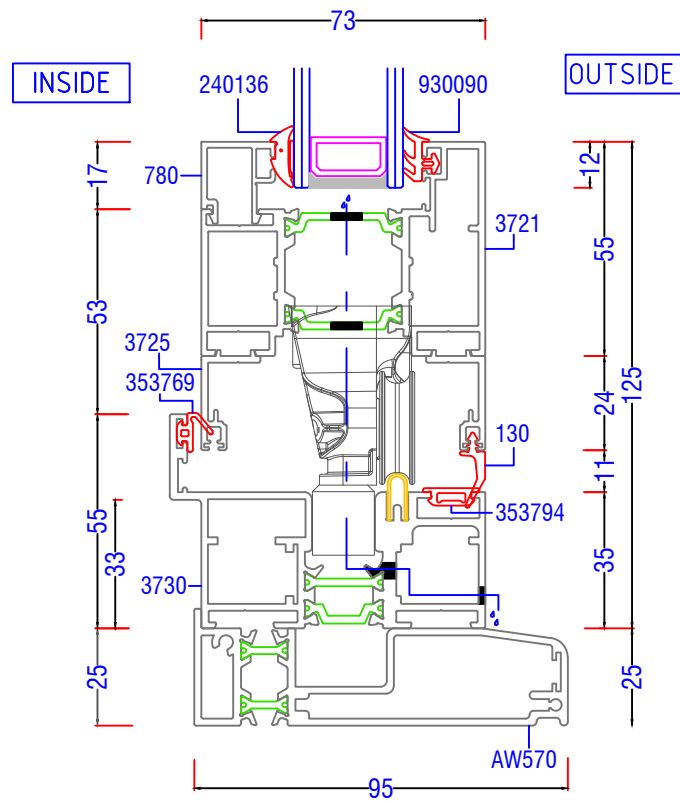
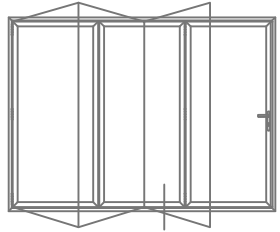

# UNIFOLD - Typical Sections

Threshold - Cill Nose option

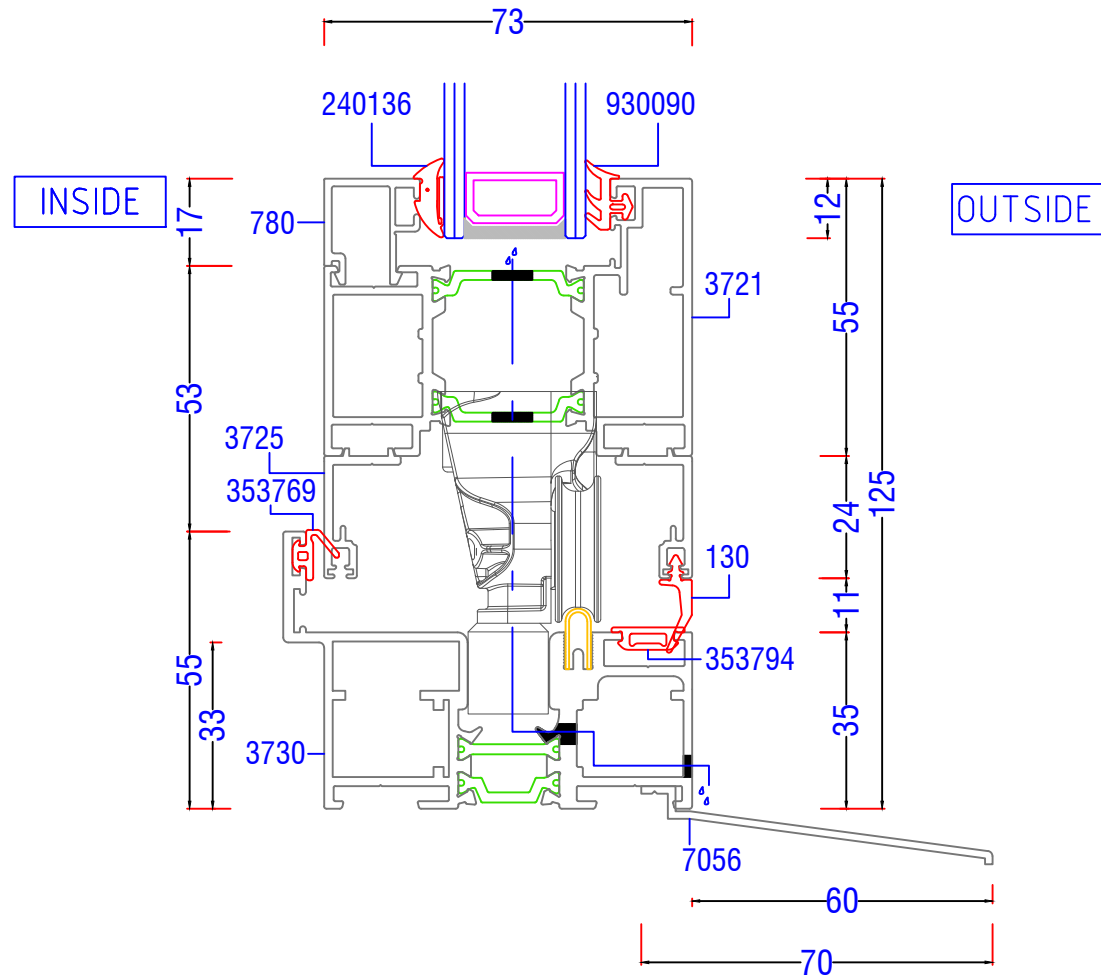
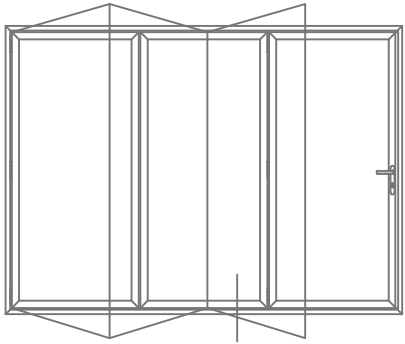





Arkay Windows is a specialist large-scale fabricator with over 30 years experience based in Watford, North West London.

Through growth built on putting our customers first, we have risen to supply some of the country's biggest retail companies, contractors and commercial installers.

 **Arkay Windows**

Watford: 01923 803923  
London: 020 8889 6821

[sales@arkaywindows.com](mailto:sales@arkaywindows.com)  
[www.arkaywindows.com](http://www.arkaywindows.com)

