



Arkay Windows

TECHNICAL DOCUMENTS

Aluk BSF70 Bifold

BSF70 - Bifold

ALUK BSF70 BI-FOLD DOOR

An intelligent combination of form and function, our highly versatile and market-leading Bi-fold sliding door system gives you maximum control over the style and operation of the doors.

Multiple panels can be added to accommodate the design specifications of your building, with the option to open in or out as required. The system also boasts a unique flush line pop-out handle that allows for square flush stacking panels when doors are fully open.

DESIGN FEATURES

- Certified under the Secured By Design scheme
- Tested to PAS 24
- Unique, pop-out handle that allows for maximum door opening and panels to stack square
- Four stainless steel rollers to ensure smooth and consistent operation

OPTIONS

- Chamfered and square bead options
- Glazing 28mm – 40mm
- Available in a range of opening configurations
- Available with heavy duty rollers; BSF70 HD
- Available in a range of single or dual colour and anodised finishes



Cill Detail

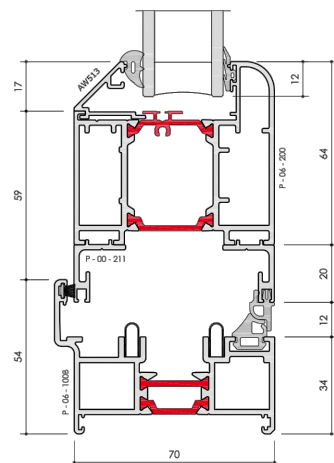

Interlock Detail

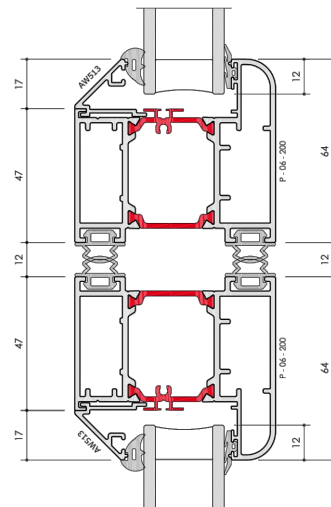

SPECIFICATIONS

PERFORMANCE AND ACCREDITATION	BSF70	BSF70 HD
• U-value (double glazing)	1.6 W/m ² K	1.6 W/m ² K
† U-value (triple glazing)	1.4 W/m ² K	1.4 W/m ² K
Air tightness (Pa) (standard threshold)	Class 4 (600 Pa)	
Water tightness (Pa) (standard threshold)	Class 9a (600 Pa)	
Wind load (Pa)	Class AE2400 (2400 Pa)	
Security	PAS 24	
3rd party certification	Q-mark	
Secured by design	✓	

CONFIGURATIONS

Opening	Open in and open out	Open in and open out
2-2-0	✓	✓
3-3-0	✓	✓
3-2-1	✓	✓
4-4-0	✓	✓
4-2-2	✓	✓
4-3-1	✓	✓
5-5-0	✓	✓
5-3-2	✓	✓
5-4-1	✓	✓
6-6-0	✓	✓
6-3-3	✓	✓
6-4-2	✓	✓
6-5-1	✓	✓
7-7-0	✓	✓
7-4-3	✓	✓
7-5-2	✓	✓
7-6-1	✓	✓

DESIGN FEATURES

Max vent weight	100 kg	130 kg
Sightline (Head)	110mm	110mm
Sightline (Cill)	130mm	130mm
Sightline (Jamb)	110mm	110mm
Sightline (Meeting Stile)	140mm	140mm

SYSTEM FEATURES

Frame depth	70mm	70mm
Dual colour option	✓	✓
Multi-point locking	✓	✓
Glazing options	Internal bead	Internal bead
Glazing thickness	24mm-40mm	24mm-40mm

* Folding Doors are calculated using: EN ISO 10077 - Part 2, 3000mm x 2180mm, 3-3-0 Door with Ug: 1.0 W/m²K (double glazing) / 0.7 W/m²K (triple glazing) using P-06-100 outerframe and P-06-200 vent. Single and Double Door value is calculated using: EN ISO 10077 - Part 2, 2000mm x 2180mm Double Door with Ug: 1.0 W/m²K (double glazing) / 0.7 W/m²K (triple glazing) using P-06-100 outerframe and P-06-200 vent.
 † U-Value (Double Glazing) - Folding Doors are calculated using: EN ISO 10077 - Part 2, 3000mm x 2180mm, 3-3-0 Door with Ug: 1.0 W/m²K using P-06-100 outerframe and P-06-200 vent. Single and Double Door value is calculated using: EN ISO 10077 - Part 2, 2000mm x 2180mm Double Door with Ug: 1.0 W/m²K using P-06-100 outerframe and P-06-200 vent.
 ‡ U-Value (Triple Glazing) - Folding Doors are calculated using: EN ISO 10077 - Part 2, 3000mm x 2180mm, 3-3-0 Door with Ug: 0.7 W/m²K using P-06-100 outerframe and P-06-200 vent. Single and Double Door value is calculated using: EN ISO 10077 - Part 2, 2000mm x 2180mm Double Door with Ug: 0.7 W/m²K using P-06-100 outerframe and P-06-200 vent.

BSF70 - Contents

- 1.0 Typical Elevations
- 2.0 Standard Profiles
- 3.0 Typical Sections
 - 3.1 Threshold - Open Out
 - 3.2 Threshold - Low Threshold
 - 3.3 Threshold - Open In
 - 3.4 Head - Open Out
 - 3.5 Head - Open In
 - 3.6 Head - Trickle Vent + 20mm Add On
 - 3.7 Jamb - Hinged Open Out
 - 3.8 Jamb - Hinged Open In
 - 3.9 Interlock - T-Handle Open Out
 - 3.10 Interlock - T-Handle Open In
 - 3.11 Interlock - Bottom Roller Open Out
 - 3.12 Interlock - Bottom Roller Open In
 - 3.13 Meeting - Traffic to Even Open Out
 - 3.14 Jamb - Traffic Door Open Out
 - 3.15 Jamb - Traffic Door Open In
 - 3.16 Meeting - Traffic to Odd Open Out
 - 3.17 Meeting - Even to Even Open Out
 - 3.18 Jamb - Even Configuration
 - 3.19 Threshold - Cill Options

BSC 94 - Typical Elevations

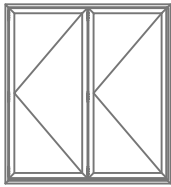

2 PANE - 220

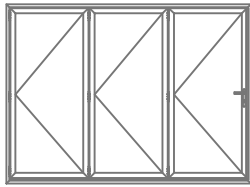

3 PANE - 330

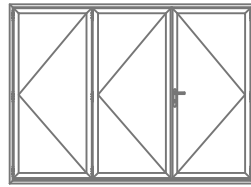

3 PANE - 321

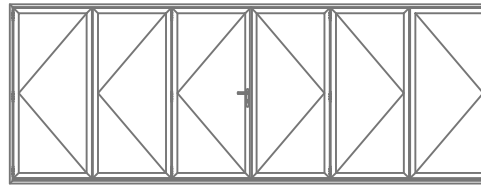

6 PANE - 633

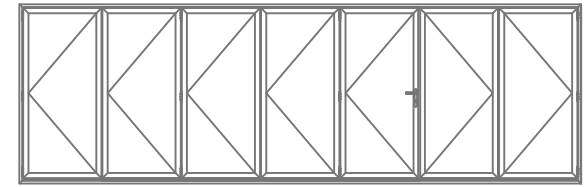

7 PANE - 752

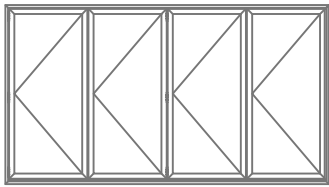

4 PANE - 440

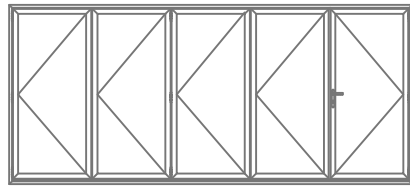

5 PANE - 541

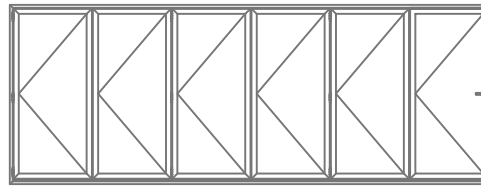

6 PANE - 660

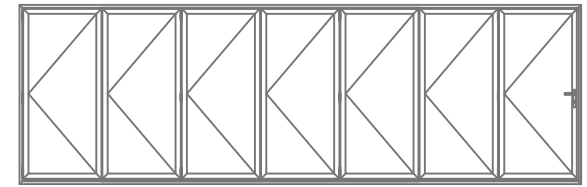

7 PANE - 770

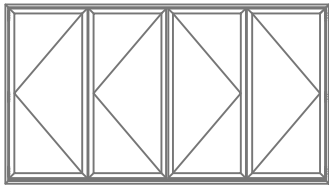

4 PANE - 422

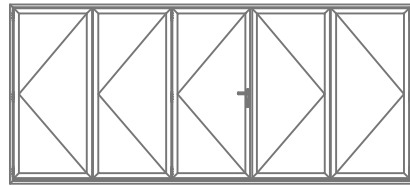

5 PANE - 532

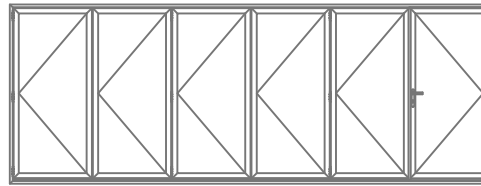

6 PANE - 651

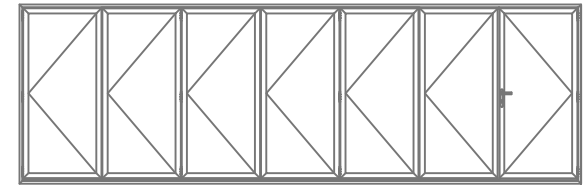

7 PANE - 761

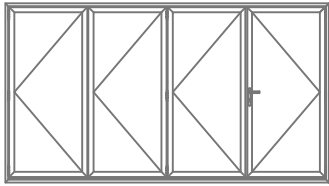

4 PANE - 431

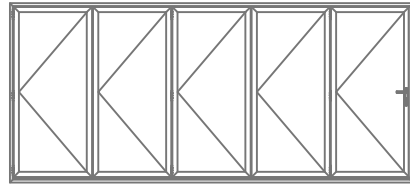

5 PANE - 550

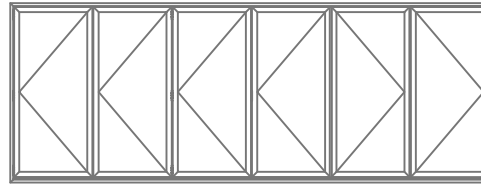

6 PANE - 642

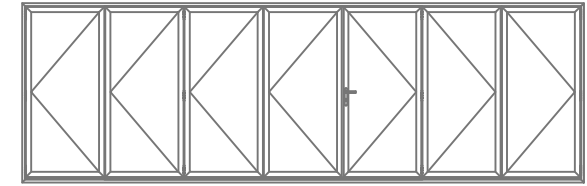

7 PANE - 743

LOW THRESHOLD OPTION AVAILABLE

OPEN IN AND OPEN OUT CONFIGURATIONS AVAILABLE



90deg CORNER OPTION AVAILABLE

BSF 70 - Standard Profiles

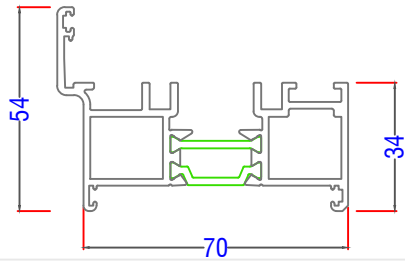

P-06-200 - Duo Rail Outer Frame

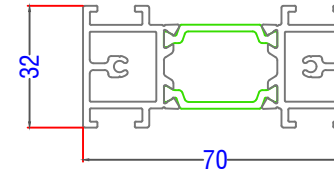

P-06-300 - FSD Floating Mullion

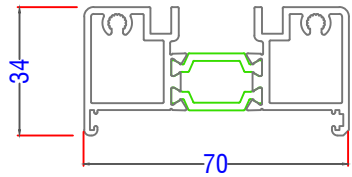

P-06-130 - Low Threshold 34mm

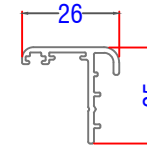

P-00-210 - FSD Rebate Adapter

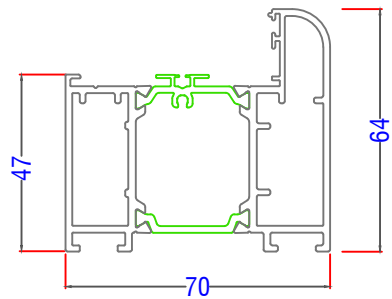

P-06-200 - BSF70 Softline Sash Profile

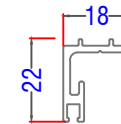

P-00-211 - FSD Threshold Adapter

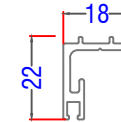

P-00-211 - FSD Threshold Adapter

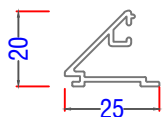

AW513 - Beveled bead 28mm

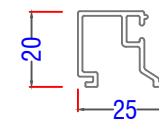

AW660 - Square bead 28mm

BSF 70 - Standard Profiles

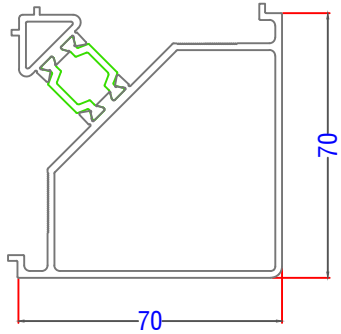

AW720 - 70mm Corner Post

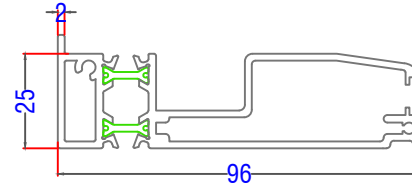

AW570 - 95mm Stub Nose Cill

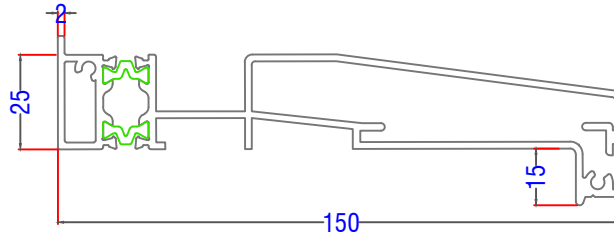

AW542 - 150mm Drop Nose Cill

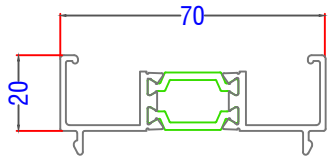

AW724 - 20mm Frame Extender (70mm)

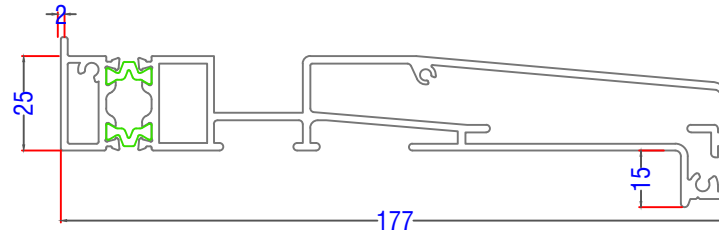

AW543 - 177mm Drop Nose Cill



RX610 - FSD Track Stainless Steel

BSF 70 - Typical Sections

Threshold - Open Out

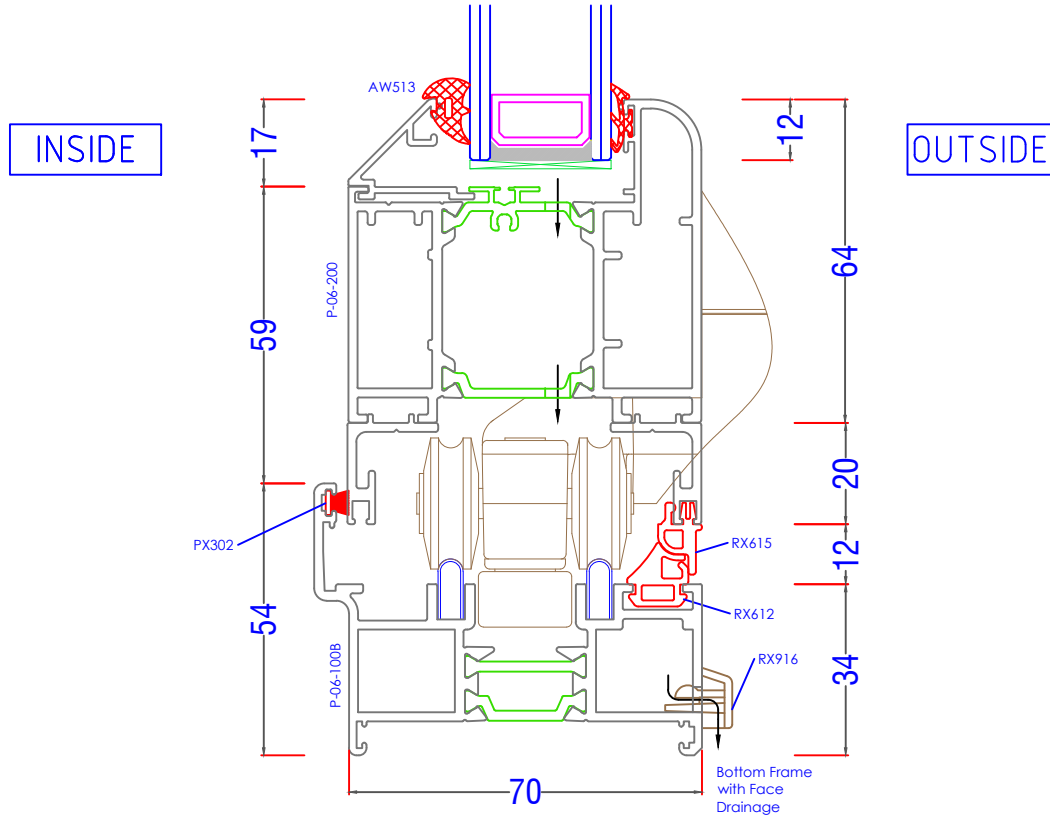
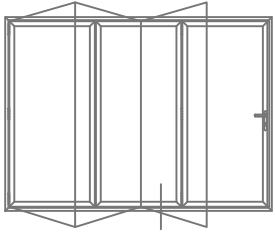

BSF 70 - Typical Sections

Threshold - Low Threshold

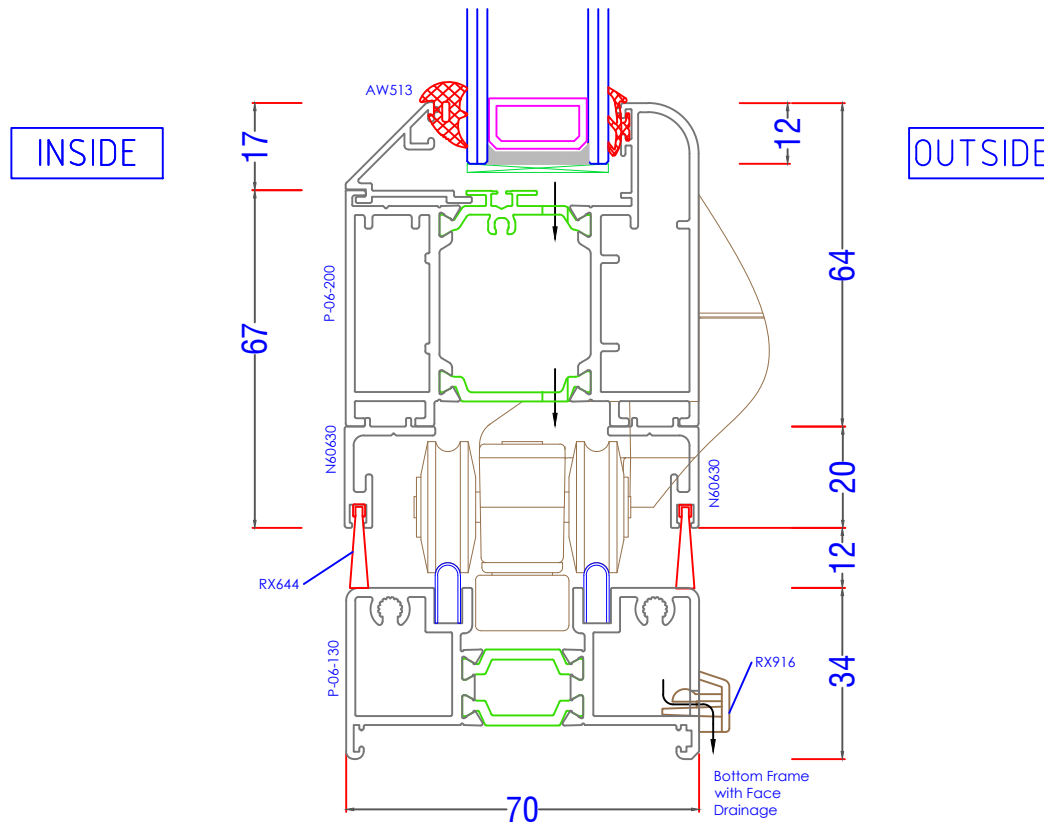
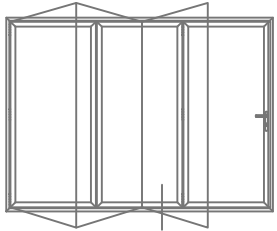

BSF 70 - Typical Sections

Threshold - Open In

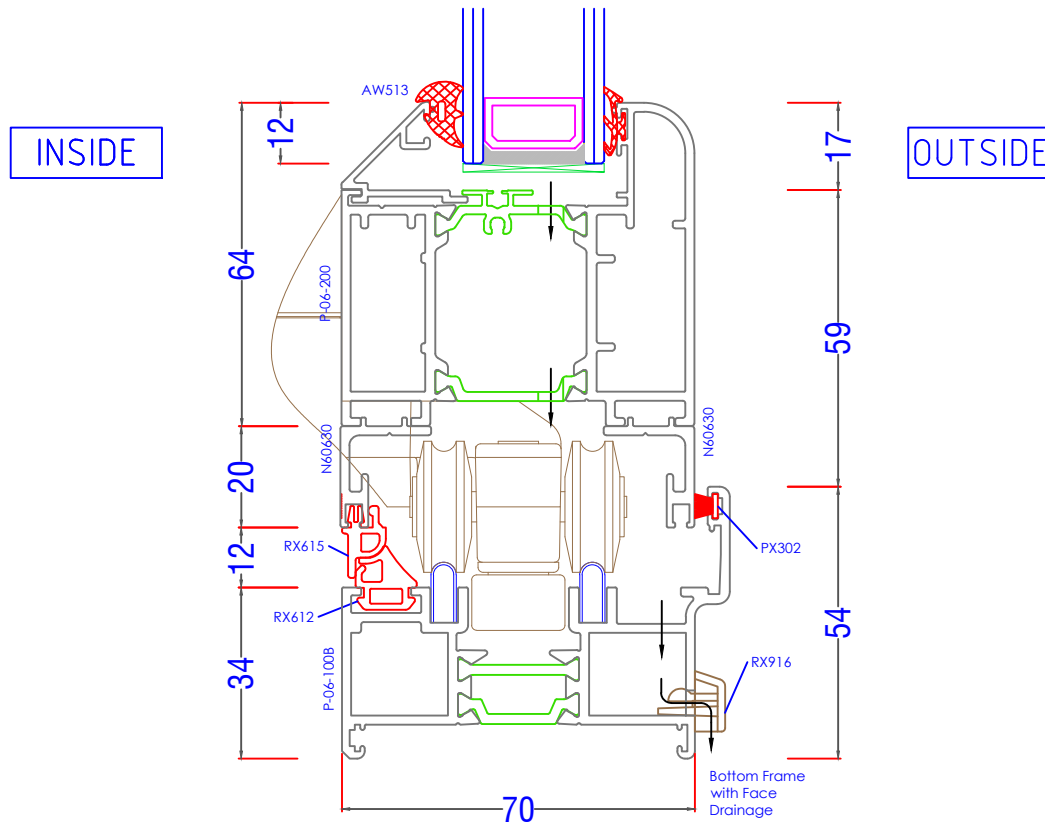
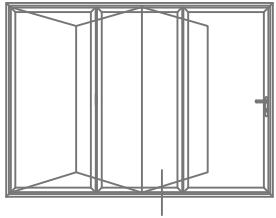

BSF 70 - Typical Sections

Head - Open Out

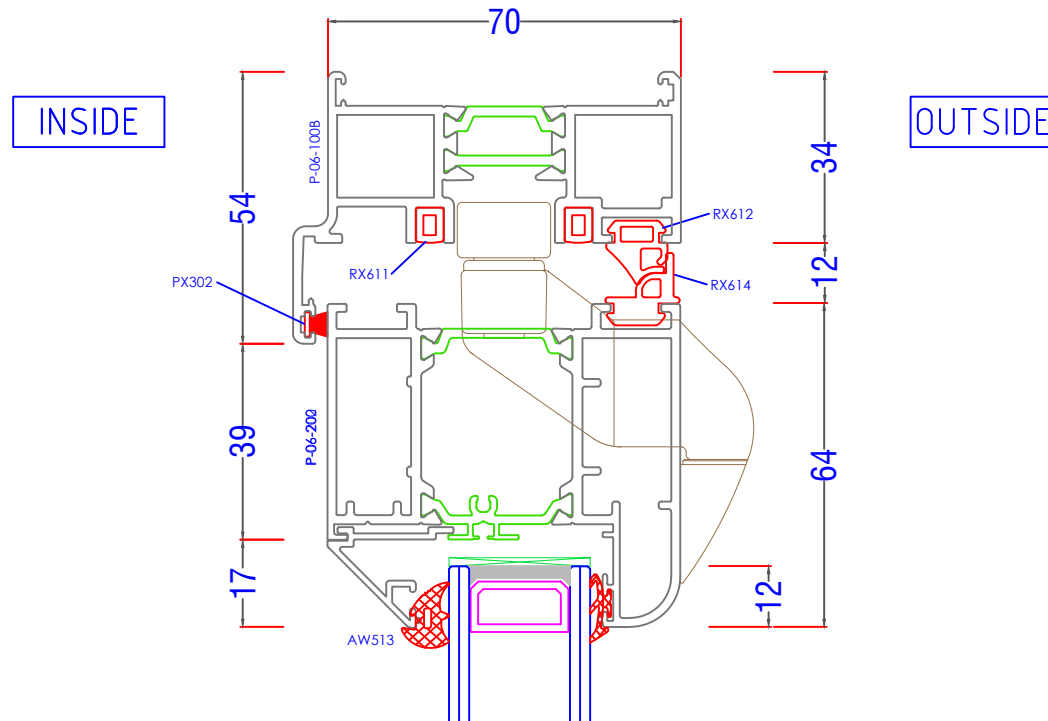
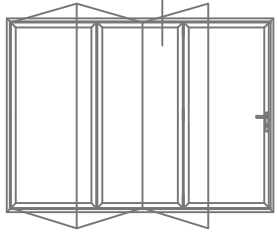

BSF 70 - Typical Sections

Head - Open In

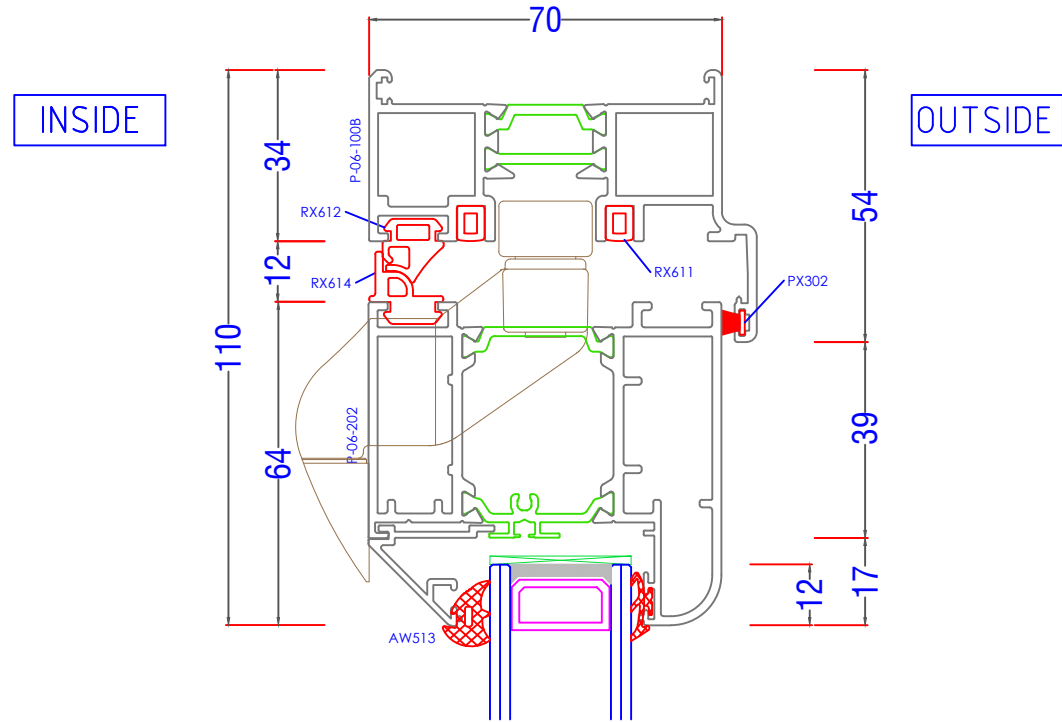
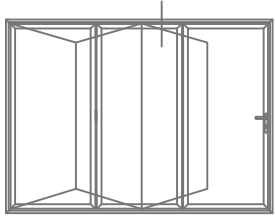

BSF 70 - Typical Sections

Head - Open In with 20mm Extension + Trickle Vent

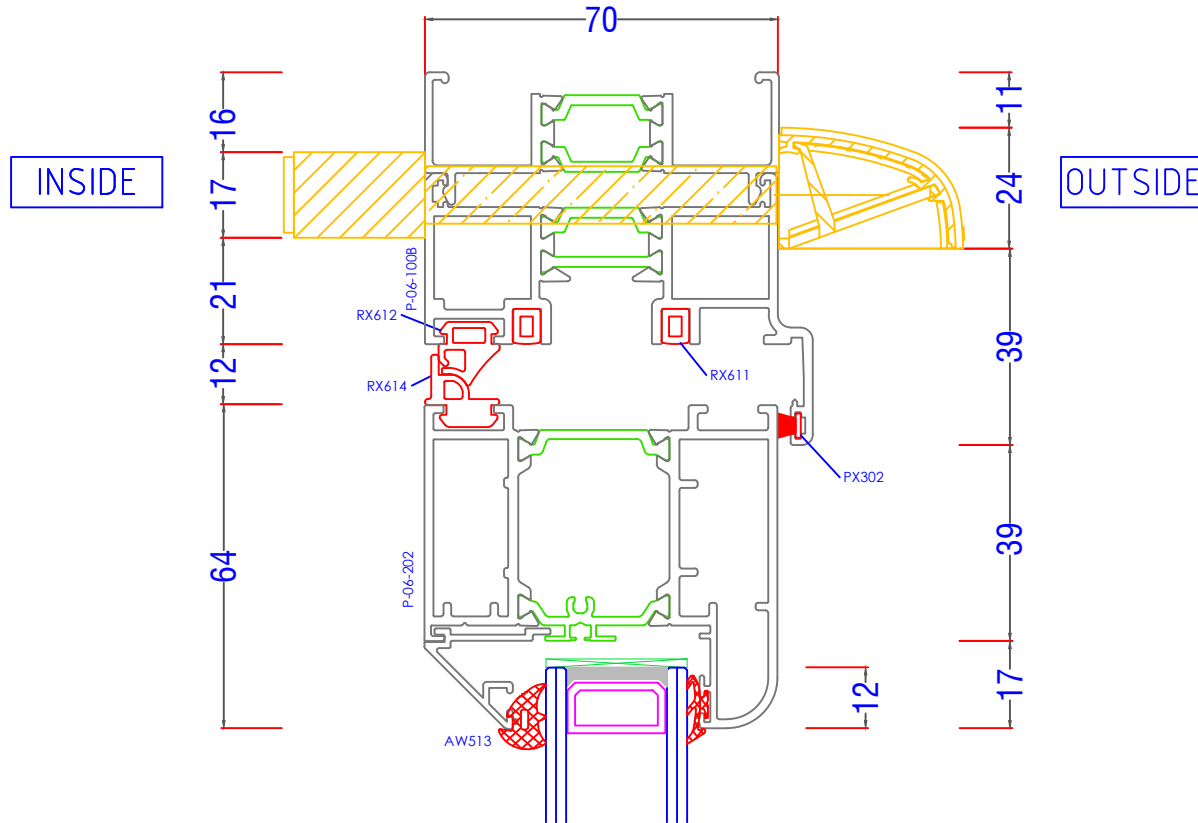
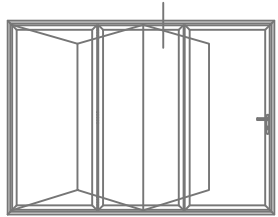

BSF 70 - Typical Sections

Jamb - Hinged Open Out

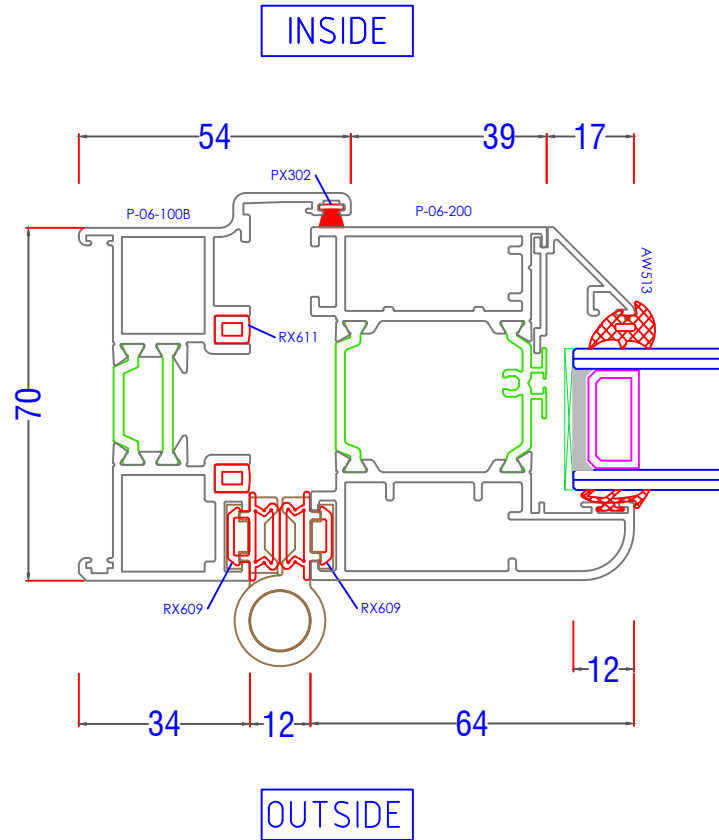
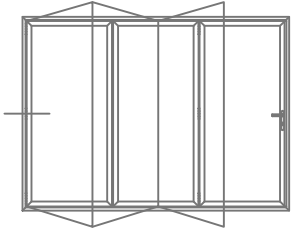

BSF 70 - Typical Sections

Jamb - Hinged Open In

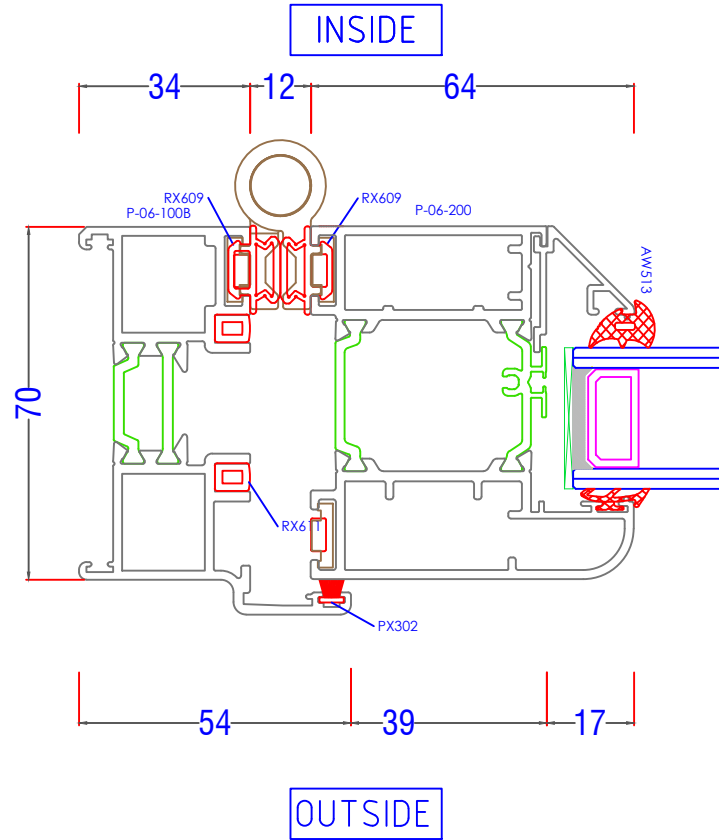
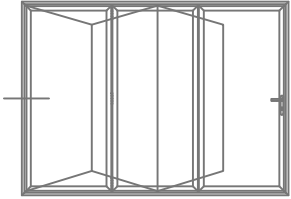

BSF 70 - Typical Sections

Interlock - T-Handle Open Out

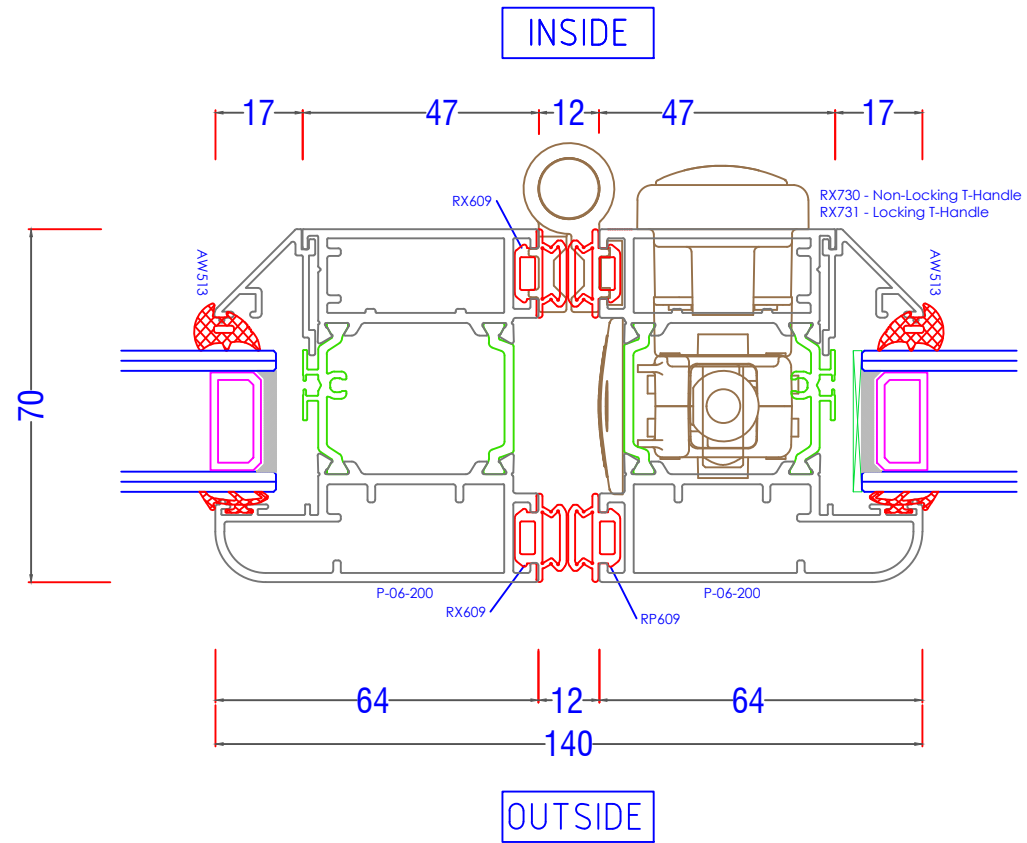
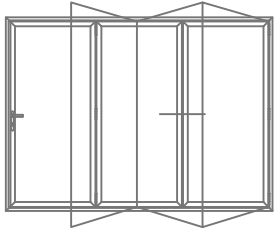

BSF 70 - Typical Sections

Interlock - T-Handle Open In

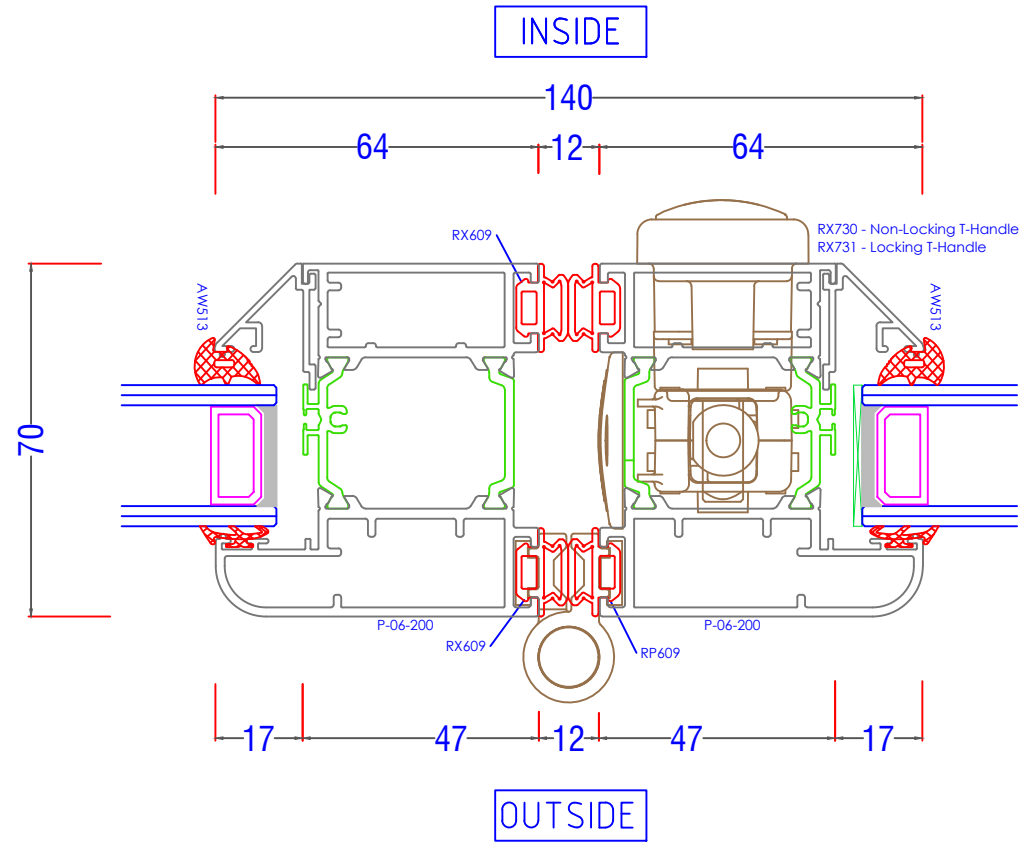
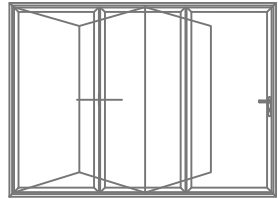

BSF 70 - Typical Sections

Interlock - Bottom Roller Open Out

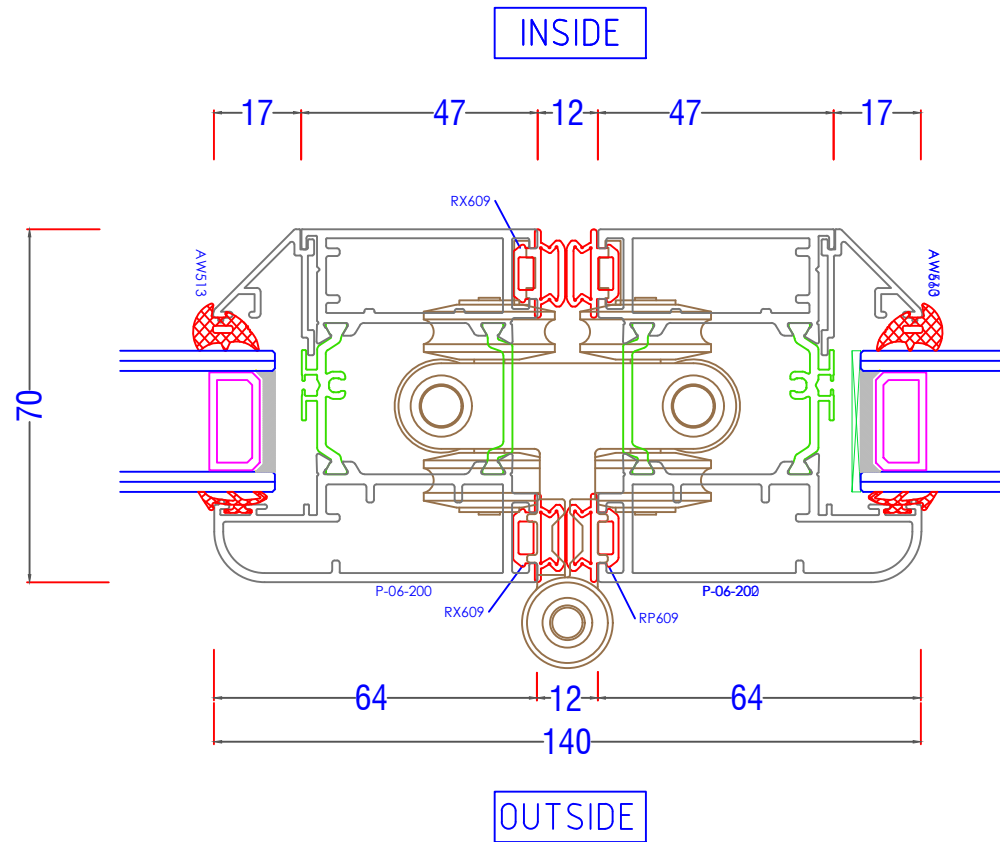
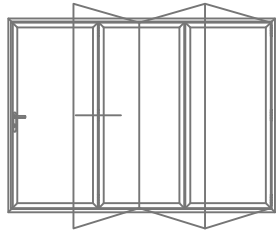

BSF 70 - Typical Sections

Interlock - Bottom Roller Open In

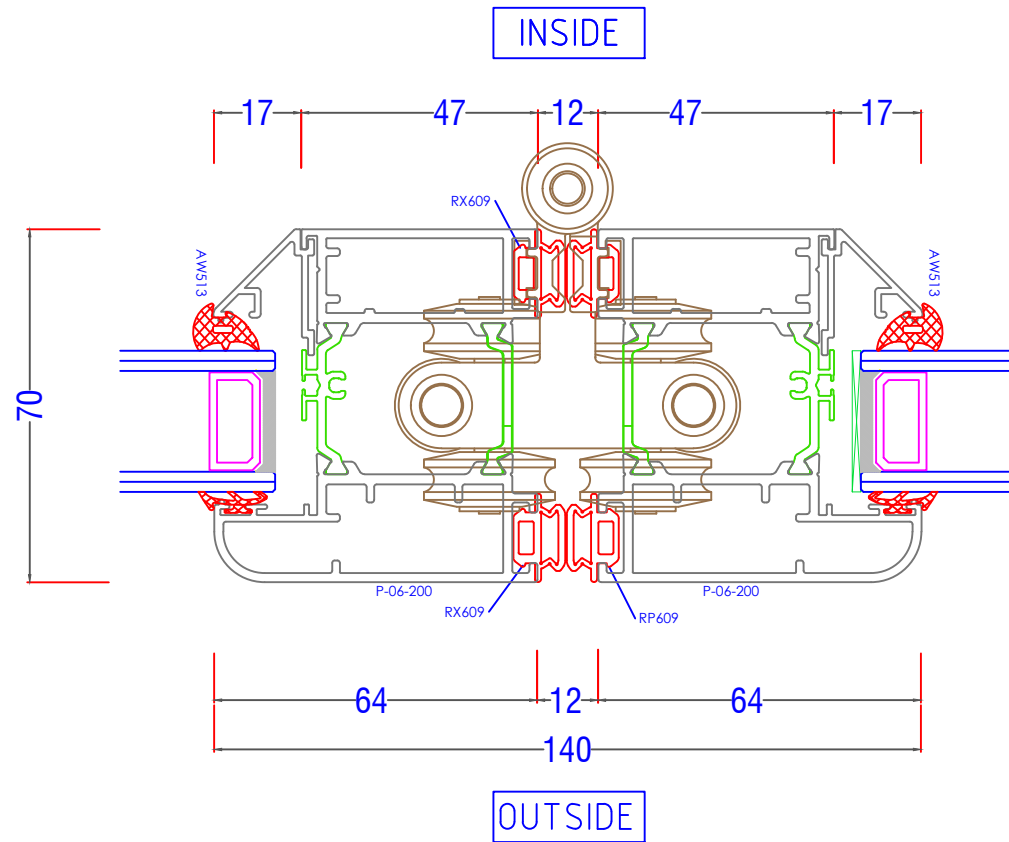
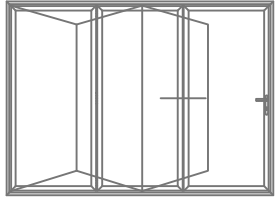

BSF 70 - Typical Sections

Meeting - Traffic To Even Open Out

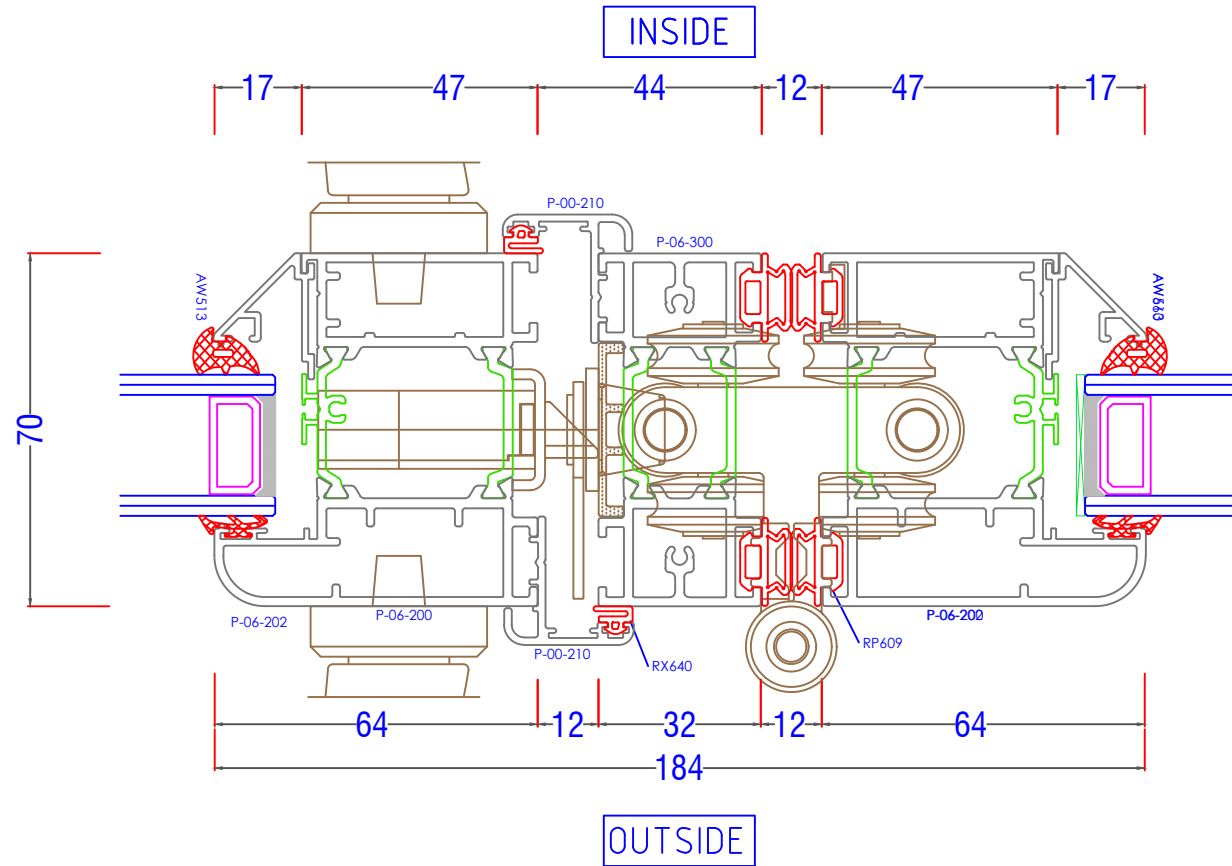
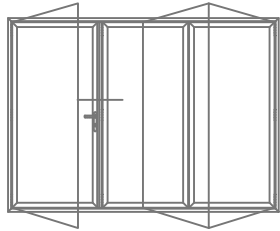

BSF 70 - Typical Sections

Jamb - Traffic Door Open Out

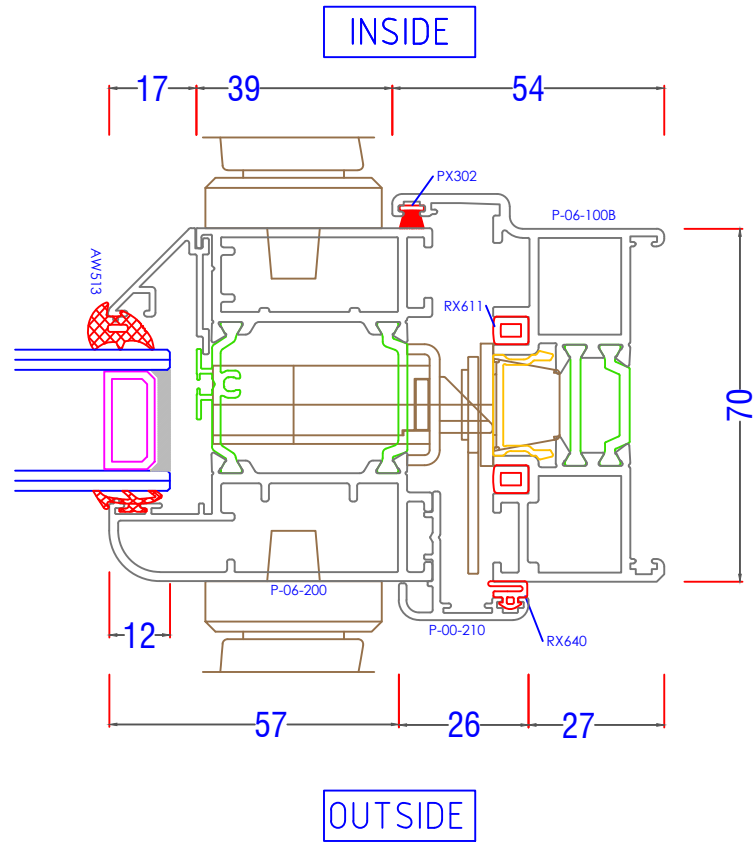
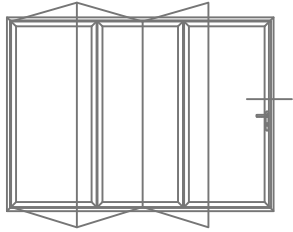

BSF 70 - Typical Sections

Jamb - Traffic Door Open In

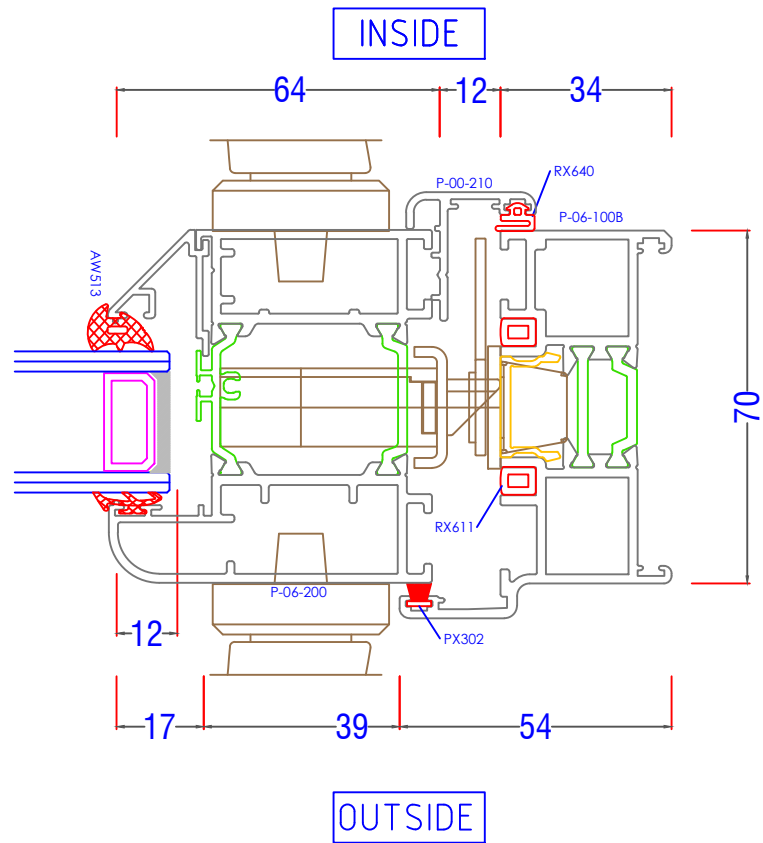
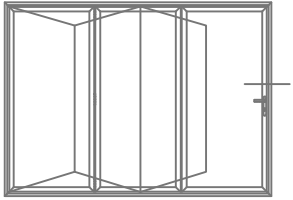

BSF 70 - Typical Sections

Meeting - Traffic To Odd Open Out

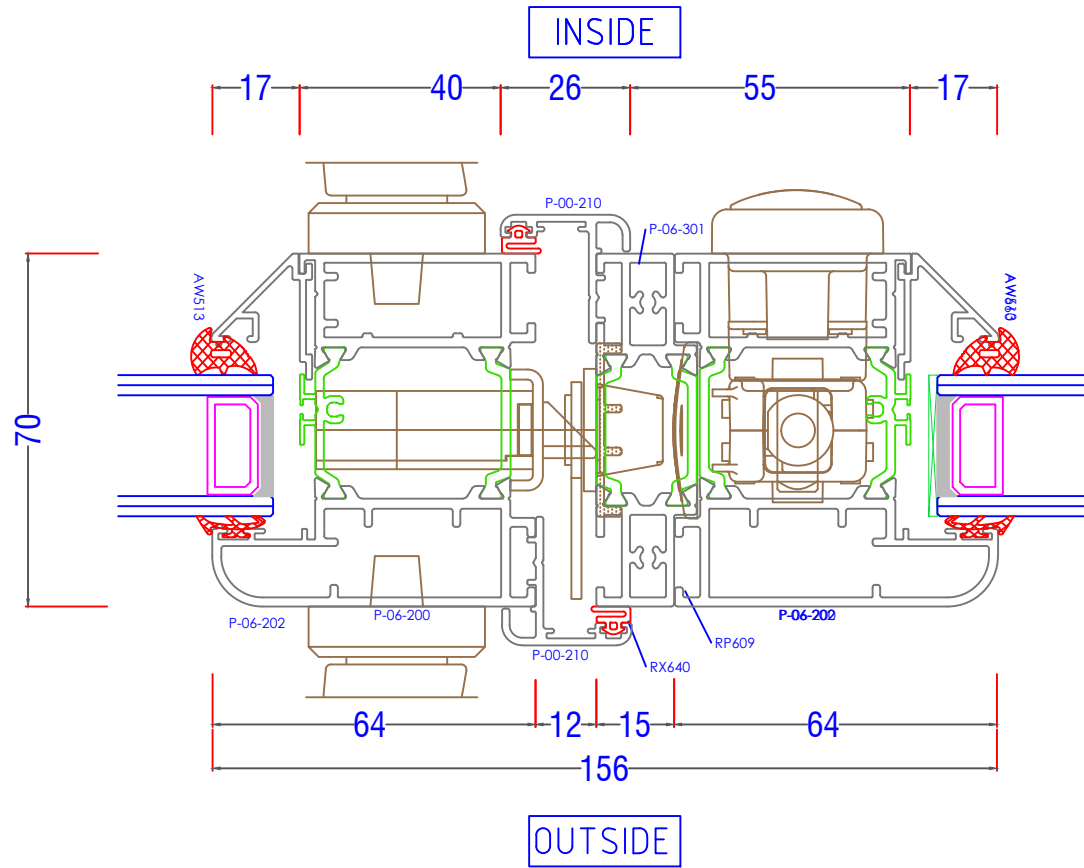
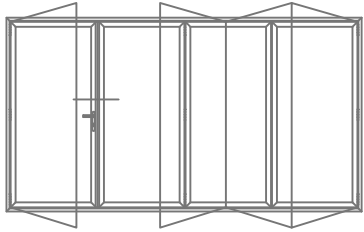

BSF 70 - Typical Sections

Meeting - EvenTo Even Open Out - No Traffic Door

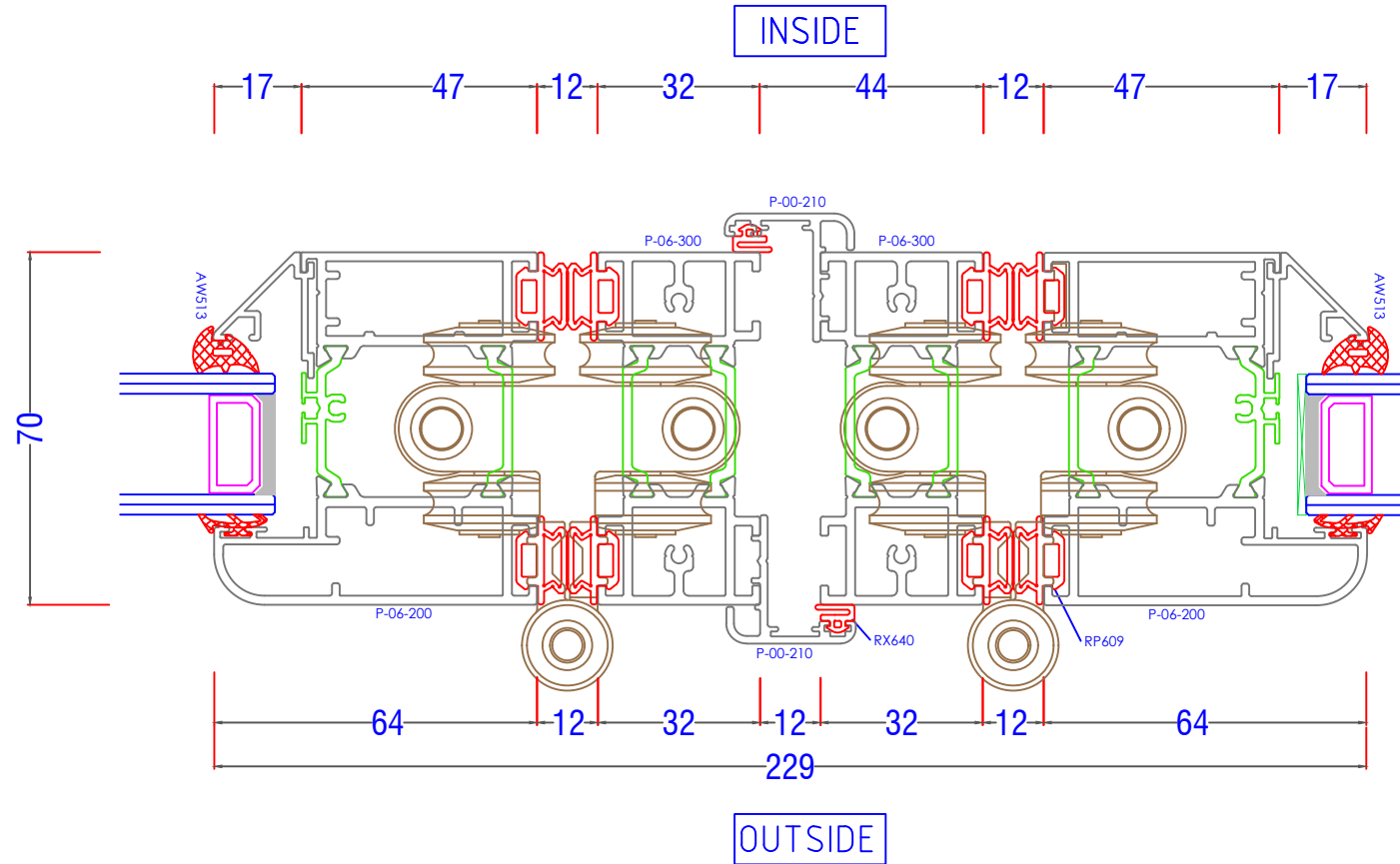
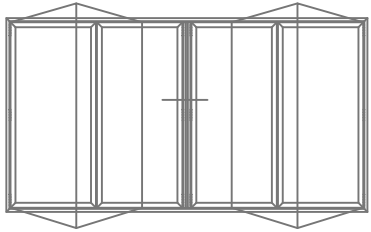

BSF 70 - Typical Sections

Jamb - Even Configuration - No Traffic Door

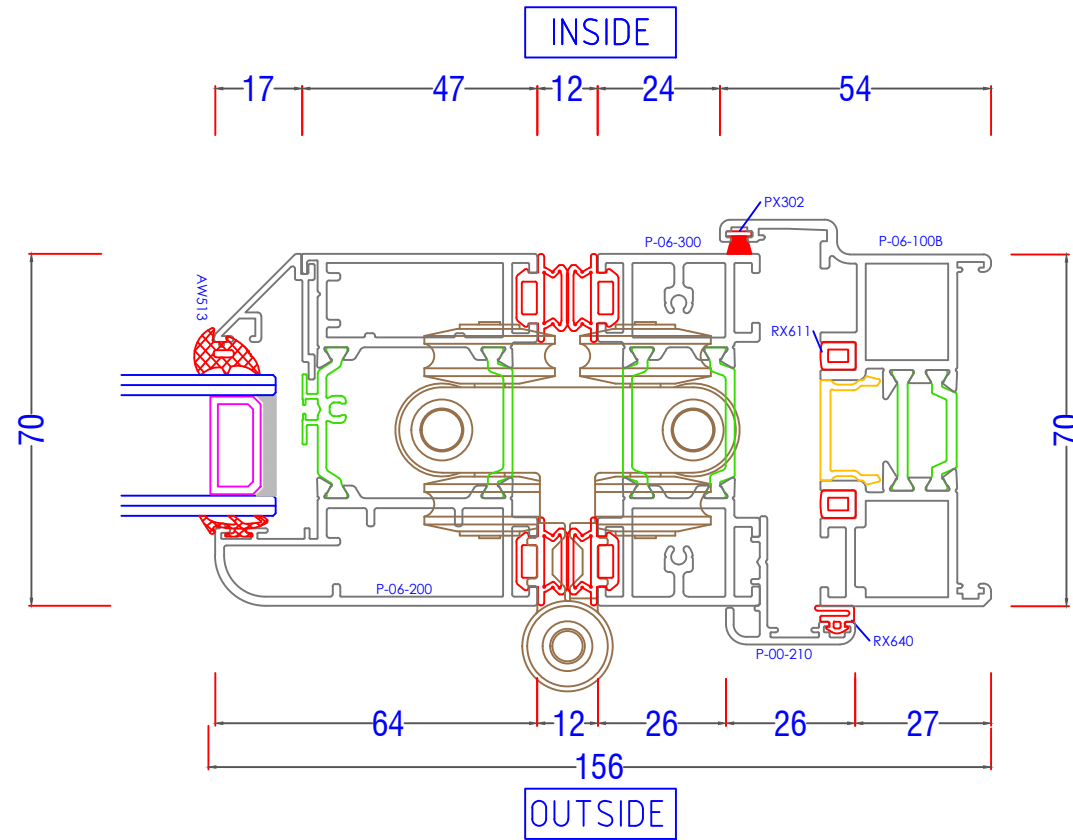
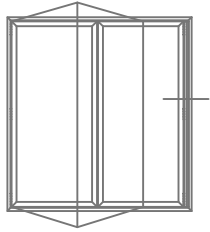

BSF 70 - Typical Sections

Threshold - Cill Options

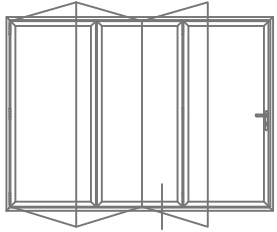

INSIDE

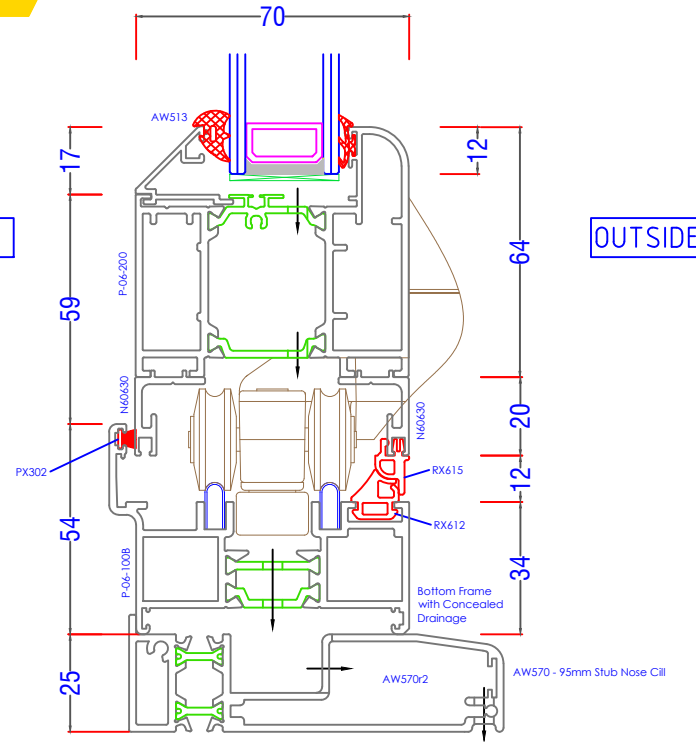

OUTSIDE

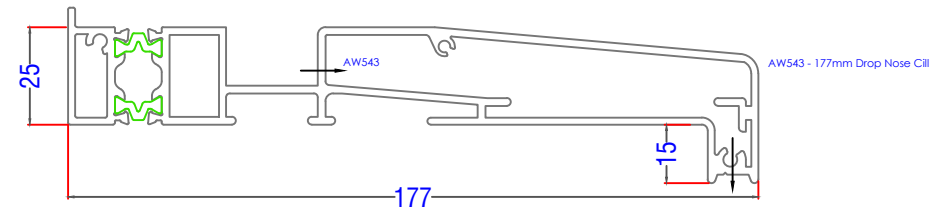
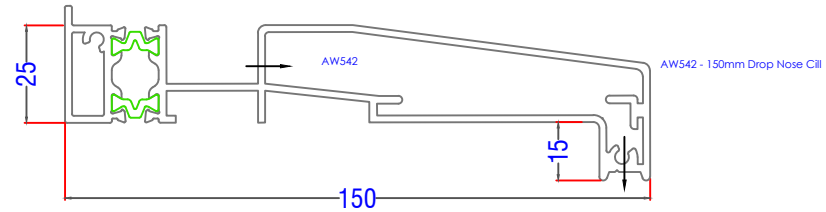

BSF 70 - Typical Sections

Corner Post - 90deg Floating Mullion

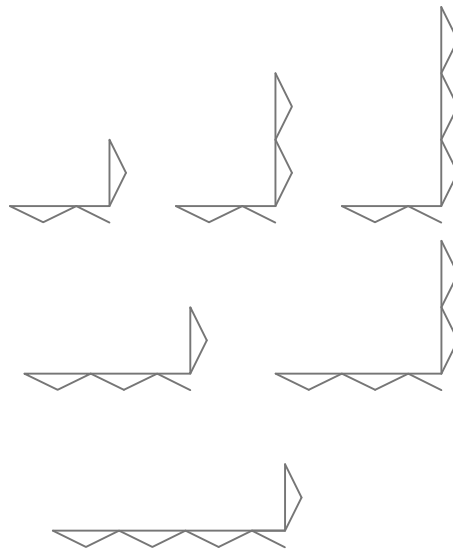
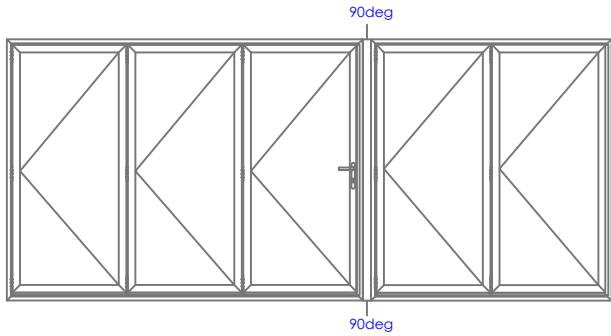

Corner Post configuration
 Odd number of vents one direction,
 Even number of vents in other direction

INSIDE

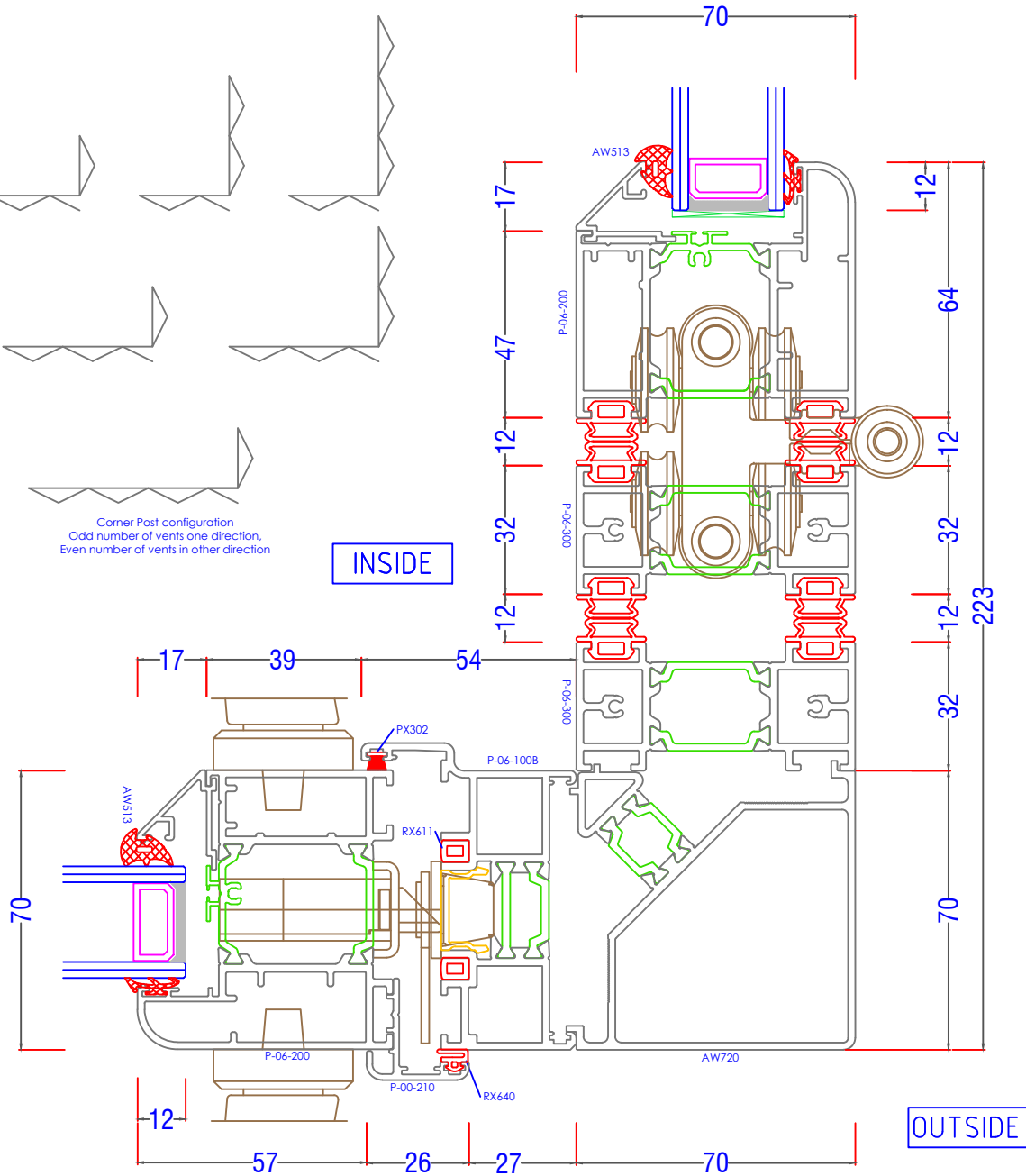



Glass & Glazing Federation Member

Official Police Security Initiative

Arkay Windows is a specialist large-scale fabricator with over 30 years experience based in Watford, North West London.

Through growth built on putting our customers first, we have risen to supply some of the country's biggest retail companies, contractors and commercial installers.

 **Arkay Windows**

Watford: 01923 803923
London: 020 8889 6821

sales@arkaywindows.com
www.arkaywindows.com

