



Arkay Windows

TECHNICAL DOCUMENTS

Aluk BSC94 Patio

BSC 94 Patio Door

BSC94 INLINE SLIDING DOOR

Combining high performance with stunning design, our sliding aluminium door systems provide a versatile solution for any architectural project. Manufactured to the highest UK standards, this multi-configuration inline system offers outstanding thermal performance and a wide range of customisable options.



DESIGN FEATURES

- Accepts 20 – 31mm double glazing
- Max 400kg panel weight
- Certified PAS 24
- Anti bi-metal polyamide strip to allow for varying expansion rates

OPTIONS

- Available as Lift & Slide
- Slimmer sightline of 45mm available
- Multiple sliding configurations
- Mono, Dual or Tri rail options
- Available in single and dual colour, anodised finishes also available
- Range of hardware and security features

Mono Rail — Cill

Dual Rail — Cill

Tri Rail — Cill

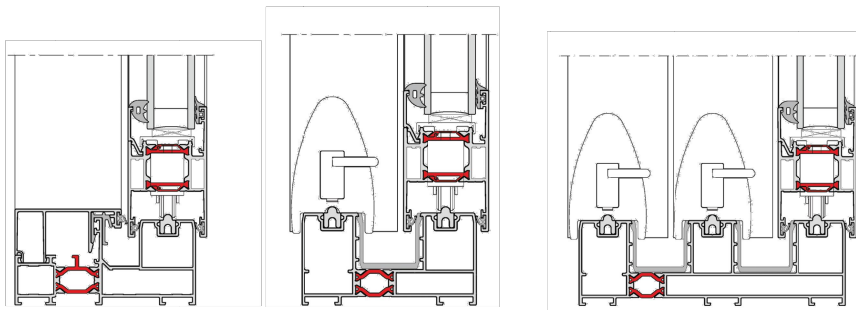

Mono Rail — Interlock

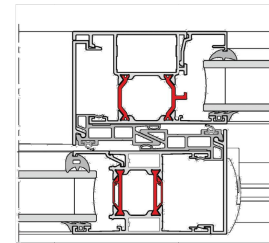

Dual/Tri Rail — Standard Interlock

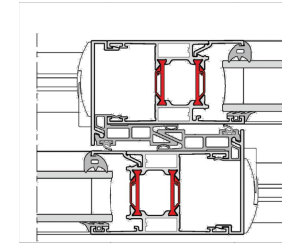

Dual/Tri Rail — Standard Slimline

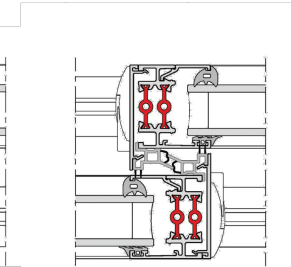

SPECIFICATIONS

PERFORMANCE & ACCREDITATION	BSC94	BSC94SLIM
U-value (Double Glazing)* (Ug = 1.0W/m²K) (Mono Rail)	1.7 W/m²K	✗
U-value (Triple Glazing)* (Ug = 0.7W/m²K) (Mono Rail)	1.5 W/m²K	✗
U-value (Double Glazing)* (Ug = 1.0W/m²K) (Dual Rail)	1.9 W/m²K	1.9 W/m²K
U-value (Triple Glazing)* (Ug = 0.7W/m²K) (Dual Rail)	1.7 W/m²K	1.6 W/m²K
Greer Guide Rating	C Rated	C Rated
Acoustic performance (dB)	Rw (C,Ctr) 36 (-1;-3) dB**	npd
Air Tightness (Pa)***	Class 4 (600 Pa)	Class 4 (600 Pa)
Water Tightness (Pa)***	Class 7a (300 Pa)	Class 7a (300 Pa)
Wind Load (Pa)***	C4 (1600 Pa)	C4 (1600 Pa)
Security — PAS24	✓	✗
CONFIGURATION & FRAME		
Opening	Inline Sliding	Inline Sliding
Mono Rail (105mm)	✓	✗
Dual Rail (94mm)	✓	✓
Tri Rail (155mm)	✓	✓
SIZE LIMITS		
Max Vent Weight****	400 kg	400 kg
Max Frame Height*	3000mm	3000mm
Max Frame Height with Security Features	2600mm	✗
SYSTEM FEATURES		
Sightline	85mm	45mm
Dual Colour Option	✓	✗
Multi-point Locking	✓	✓
Glazing Options	Internal	Internal
Glazing Thickness	20mm-31mm	20mm-31mm

*U-Value (Double Glazing) - Single Doors calculated using EN ISO 10077 - Part 2, 1000mm x 2100mm Single Door with Ug: 1.0W/m²K using AW604 outer frame and AC2000/AC201 vent. Double Doors see calculated using EN ISO 10077 - Part 2, 2000mm x 2100mm Single Door with Ug: 1.0W/m²K using AW604 outer frame and AC2000/AC201 vent.
 **U-Value (Triple Glazing) - Single Doors calculated using EN ISO 10077 - Part 2, 1000mm x 2100mm Single Door with Ug: 0.7W/m²K using AW604 outer frame and AC2000/AC201 vent. Double Doors see calculated using EN ISO 10077 - Part 2, 2000mm x 2100mm Single Door with Ug: 0.7W/m²K using AW604 outer frame and AC2000/AC201 vent.

- 1.0 Typical Elevations
- 2.0 Standard Profiles
- 3.0 Typical Sections
 - 3.1 Duo Frame - Fixed Jamb
 - 3.2 Duo Frame - Locking Jamb
 - 3.3 Tri Frame - Fixed Jamb
 - 3.4 Tri Frame - Locking Jamb
 - 3.5 Duo Frame - Fixed Panel Threshold
 - 3.6 Duo Frame - Sliding Panel Threshold
 - 3.7 Tri Frame - Fixed Panel Threshold
 - 3.8 Tri Frame - Sliding Panel Threshold
 - 3.9 Duo Frame - Fixed Panel Head
 - 3.10 Duo Frame - Sliding Panel Head
 - 3.11 Tri Frame - Fixed Panel Head
 - 3.12 Tri Frame - Sliding Panel Head
 - 3.13 Interlocks - Standard
 - 3.13a Standard Size Limits
 - 3.13b Standard - Reinforced Outside Only
 - 3.13c Standard - Reinforced Inside & Outside
 - 3.14 Interlocks - Slim
 - 3.14a Slim Size Limits
 - 3.14b Slim - Reinforced Outside Only
 - 3.14c Slim - Reinforced Inside & Outside
 - 3.15 Meeting Section
 - 3.16 Duo Frame - Cill Options
 - 3.17 Tri Frame - Cill Options
 - 3.18 Frame Extenders & Trickle Vent

BSC 94 - Typical Elevations

DUAL TRACK
 APPLICABLE FOF IN-LINE SLIDING - STANDARD AND SLIM INTERLOCK

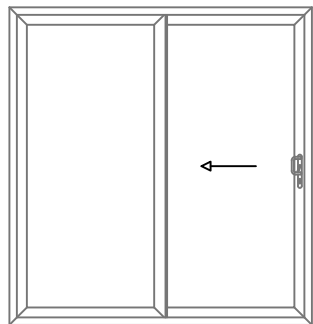

DUO RAIL
 O X

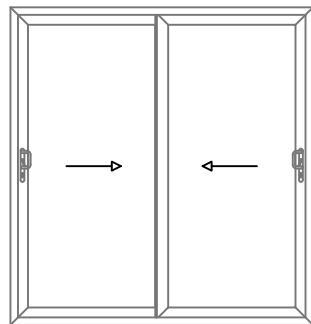

DUO RAIL
 X X

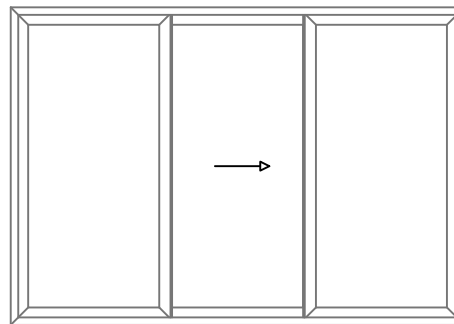

DUO RAIL
 O X O

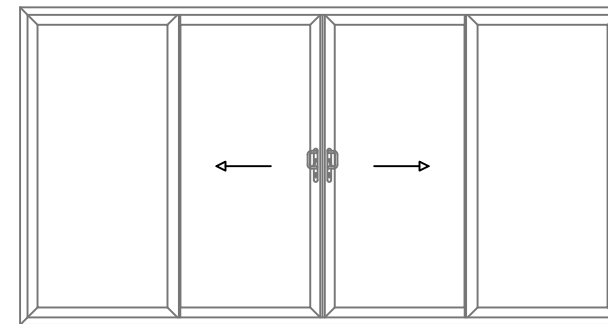

DUO RAIL
 O X X O

DUAL TRACK
 APPLICABLE FOF IN-LINE SLIDING - STANDARD AND SLIM INTERLOCK

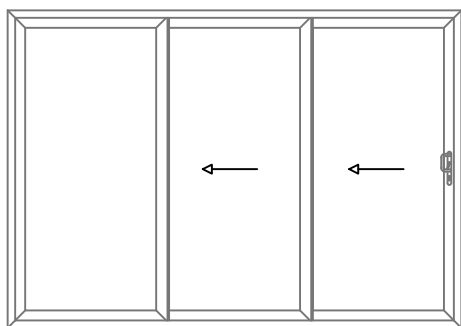

TRI RAIL
 O X X

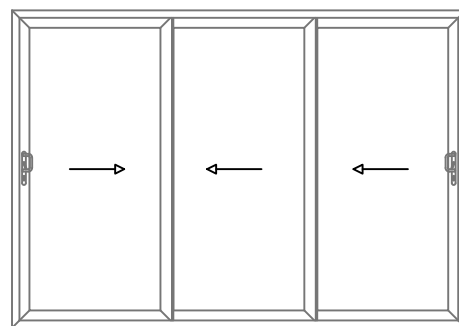

TRI RAIL
 X X X

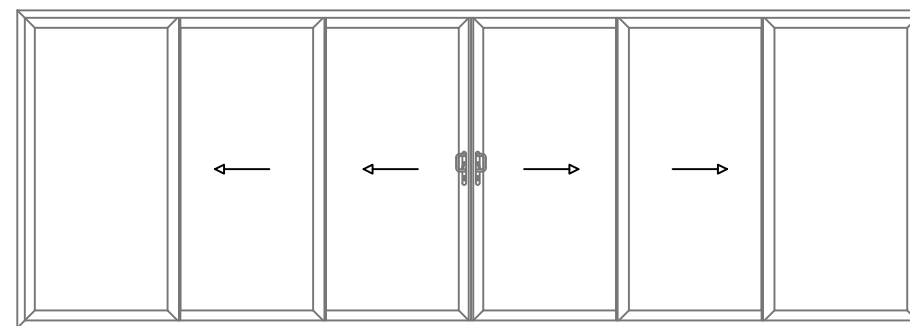

TRI RAIL
 O X X X X O

BSC 94 - Standard Profiles

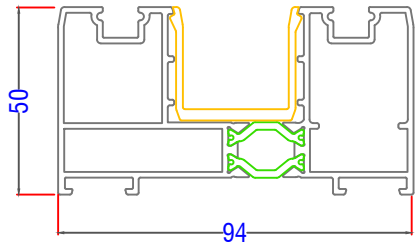

P-15-100 - Duo Rail Outer Frame

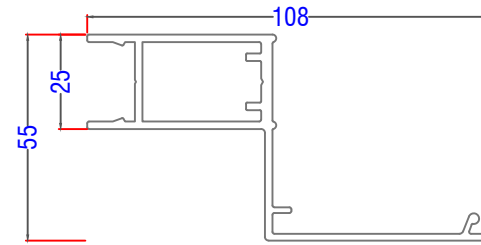

P-15-301 - Reinforced Interlock Finishing Profile

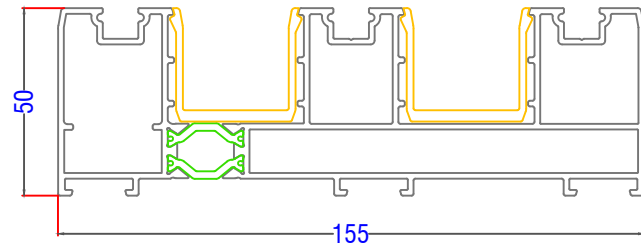

P-15-113 - Tri rail Outer Frame

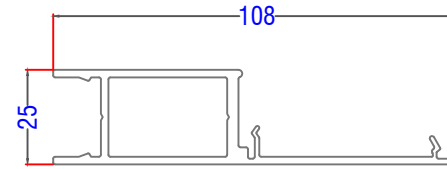

P-15-303 - Inline Slim Reinforced Finishing profile

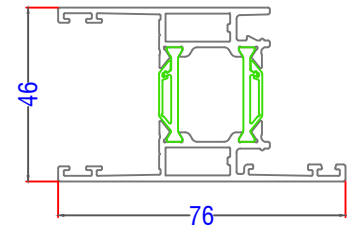

P-15-202 - Inline Sliding Door Vent

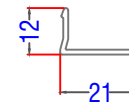

P-00-500 - Reinforced Capping profile

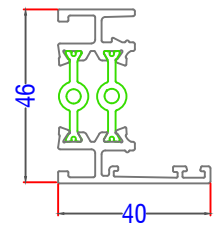

P-15-210 - Inline Slim Interlock

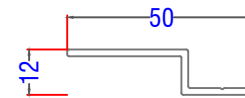

P-00-520 - Z-Profile

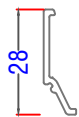

P-6N-003 - Glazing beam 3mm
(28mm IGU)

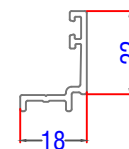

P-00-101 - Outer Frame Extension Profile

BSC 94 - Standard Profiles

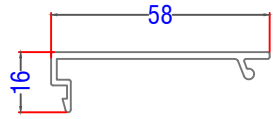

P-15-300 - Interlock Finishing profile

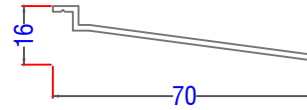

7056 - Cill Extension 70mm

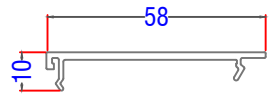

P-15-302 - Slim interlock Finishing Profile

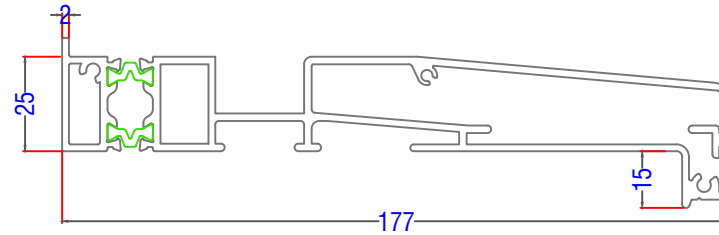

AW543 - 177mm Drop Nose Cill

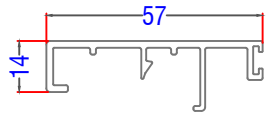

P-15-403 - Outer Frame Plain Plate

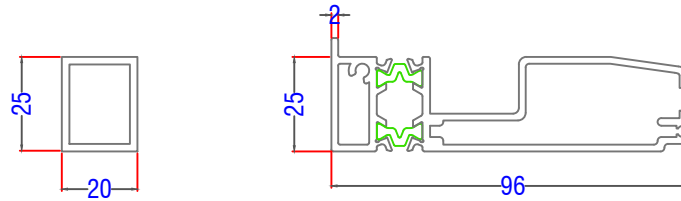

AW570 - 95mm Stub Cill
(use with P-00-940 only)

P-00-940 - Rectangular tube 20x25mm - I
(used with 150mm Drop Nose Cill
on Tri-rail)

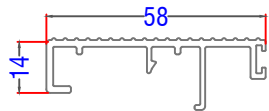

P-15-402 - Cill/Threshold Tread Plate

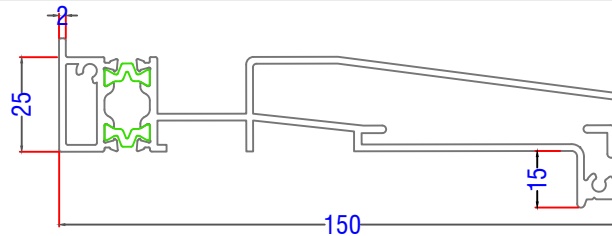

AW542 - 150mm Drop Nose Cill
(used with Rectangular Tube on Tri-rail)



P-05-801 - Sliding Door Track
(Stainless Steel)

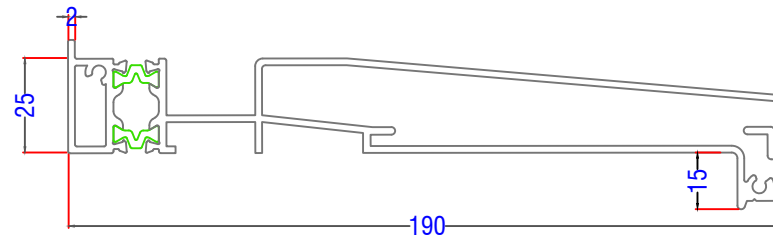

AW544 - 190mm Drop Nose Cill

BSC 94 - Typical Sections

Duo Frame - Fixed Jamb

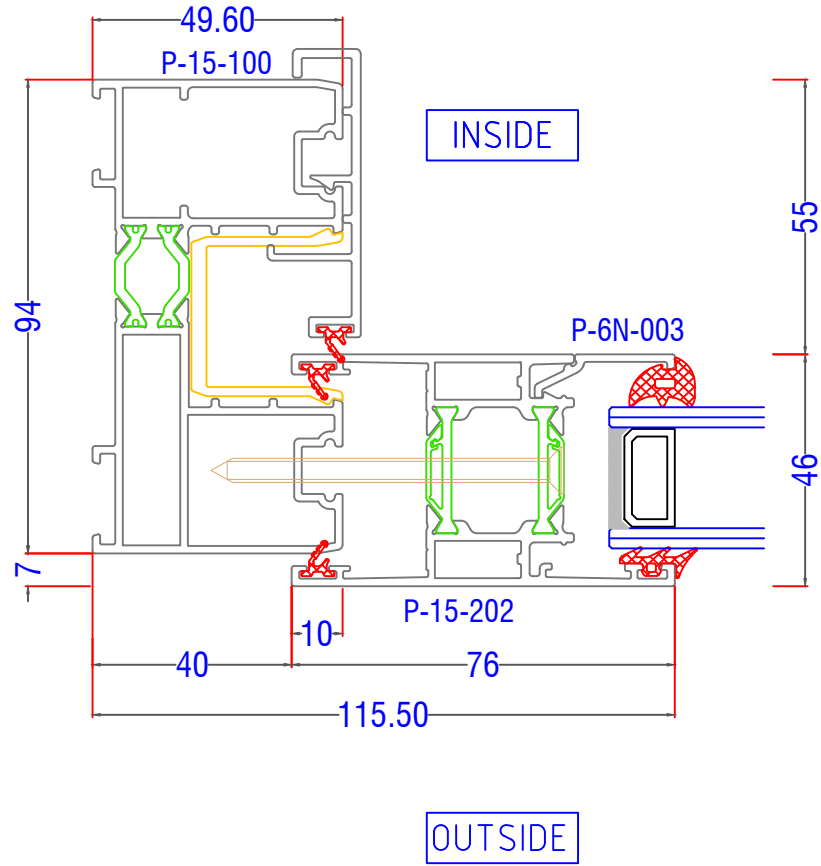
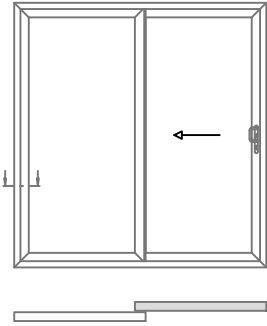

BSC 94 - Typical Sections

Duo Frame - Locking Jamb

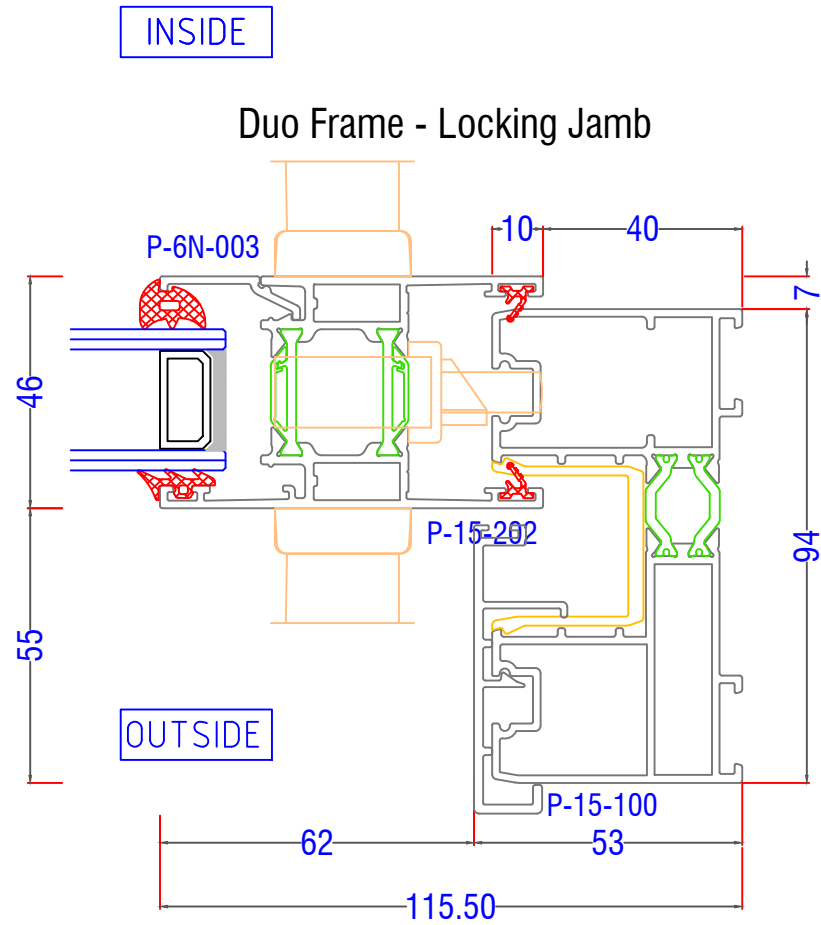
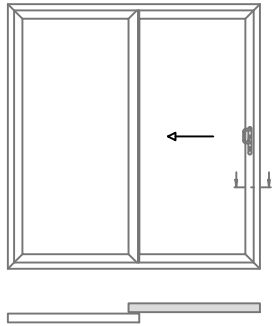

BSC 94 - Typical Sections

Tri Frame - Fixed Jamb

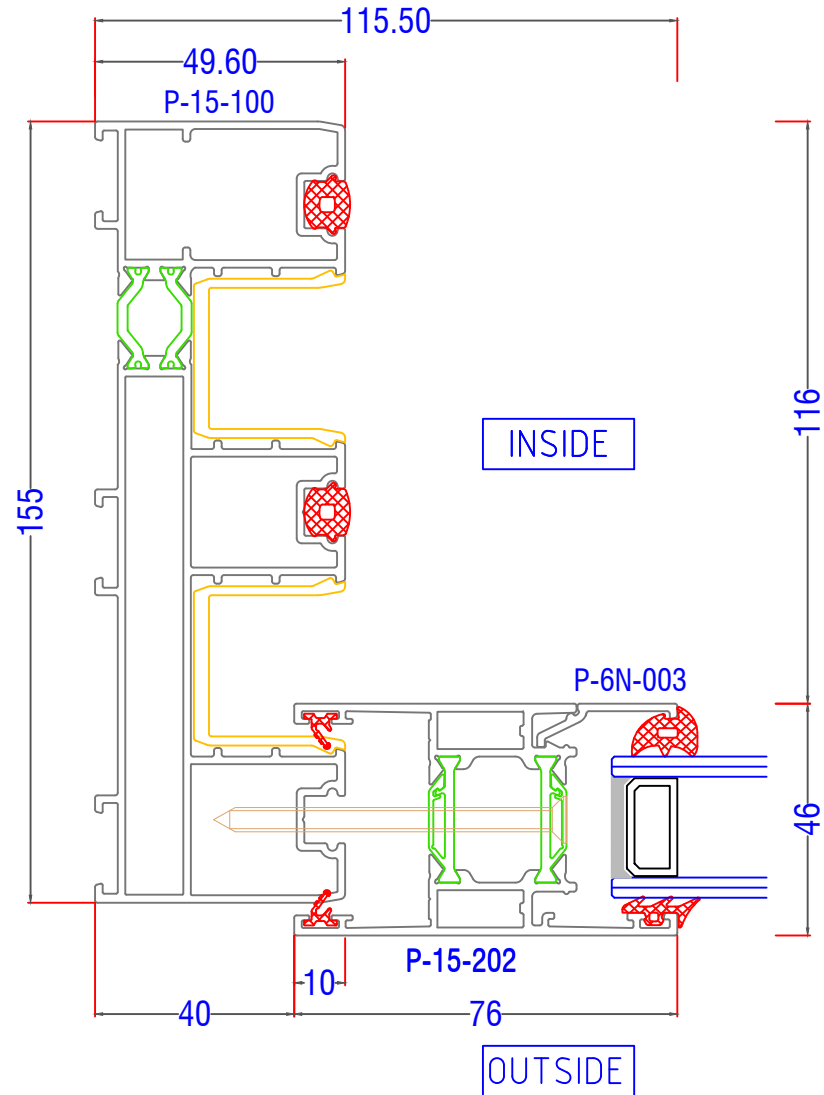
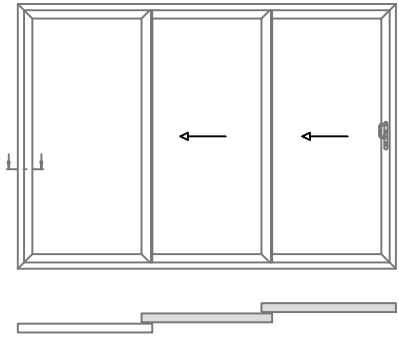

BSC 94 - Typical Sections

Tri Frame - Locking Jamb

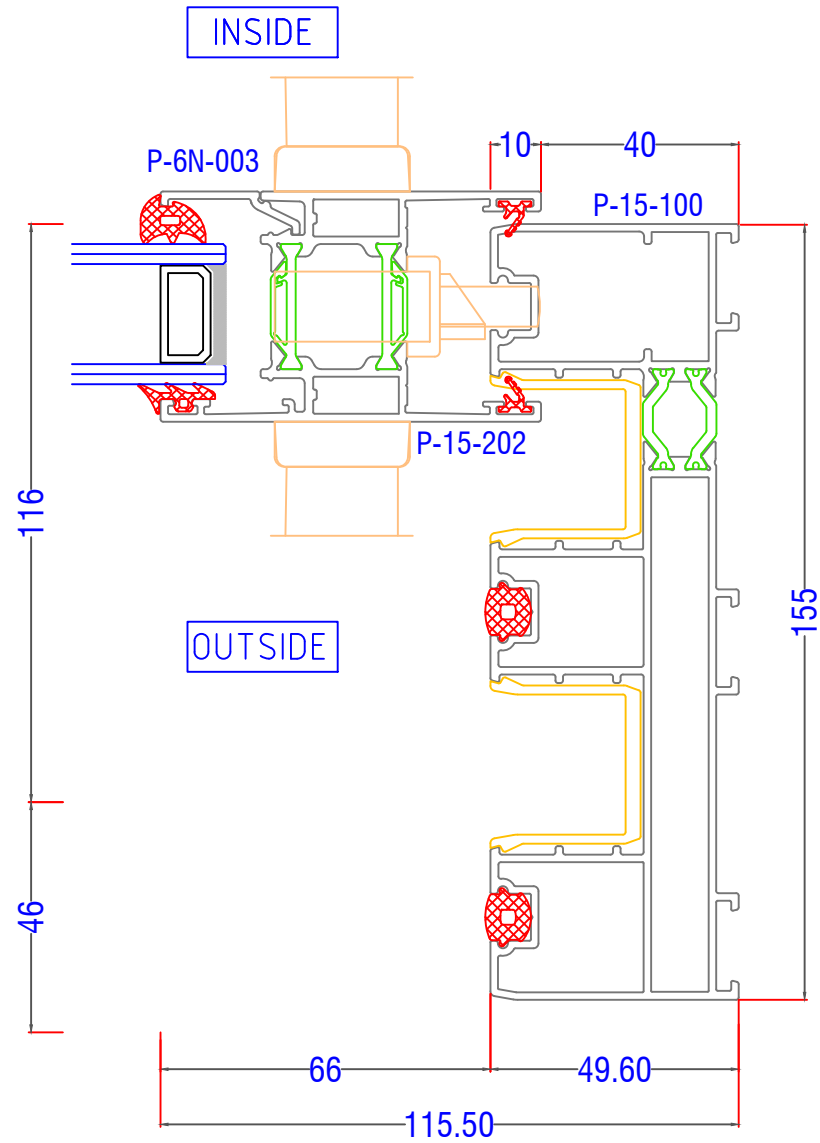
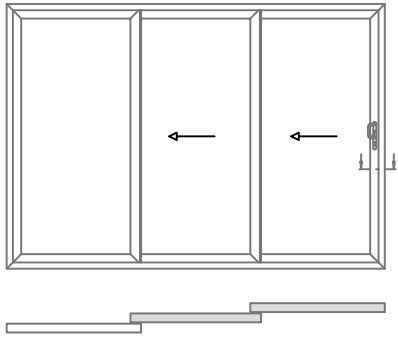

BSC 94 - Typical Sections

Duo Frame - Fixed Panel Threshold

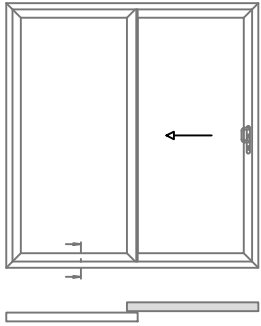

Duo Frame - Fixed Panel

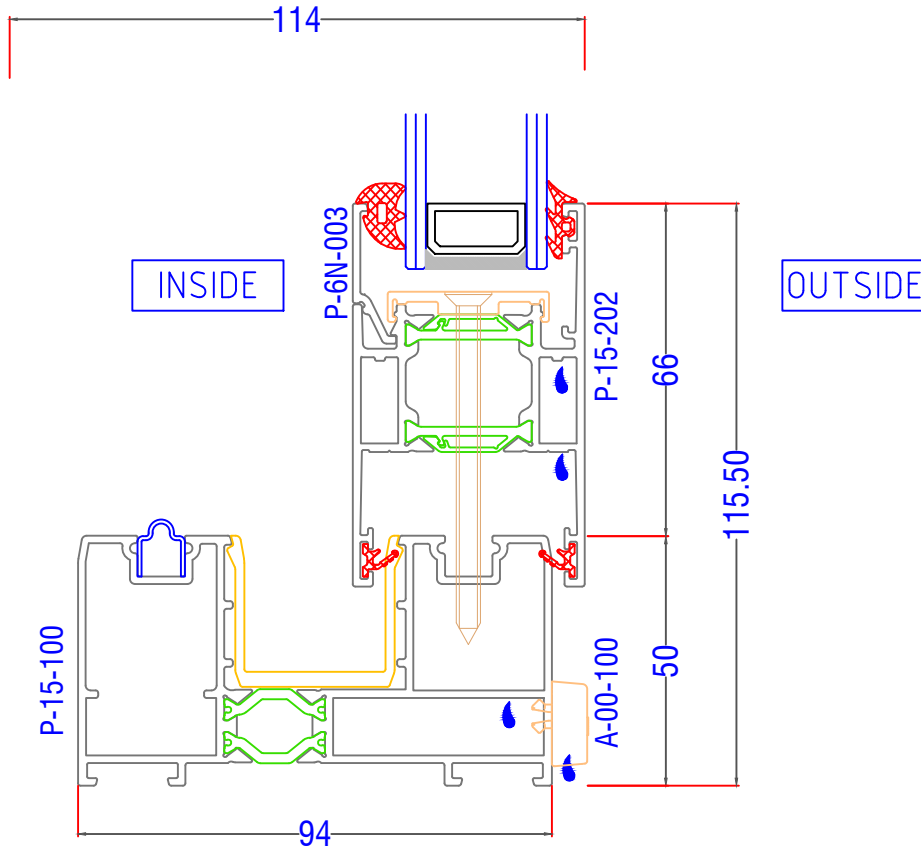

BSC 94 - Typical Sections

Duo Frame - Sliding Panel Threshold

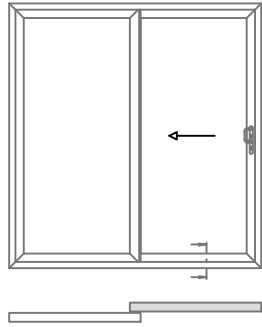

Duo Frame - Sliding Panel

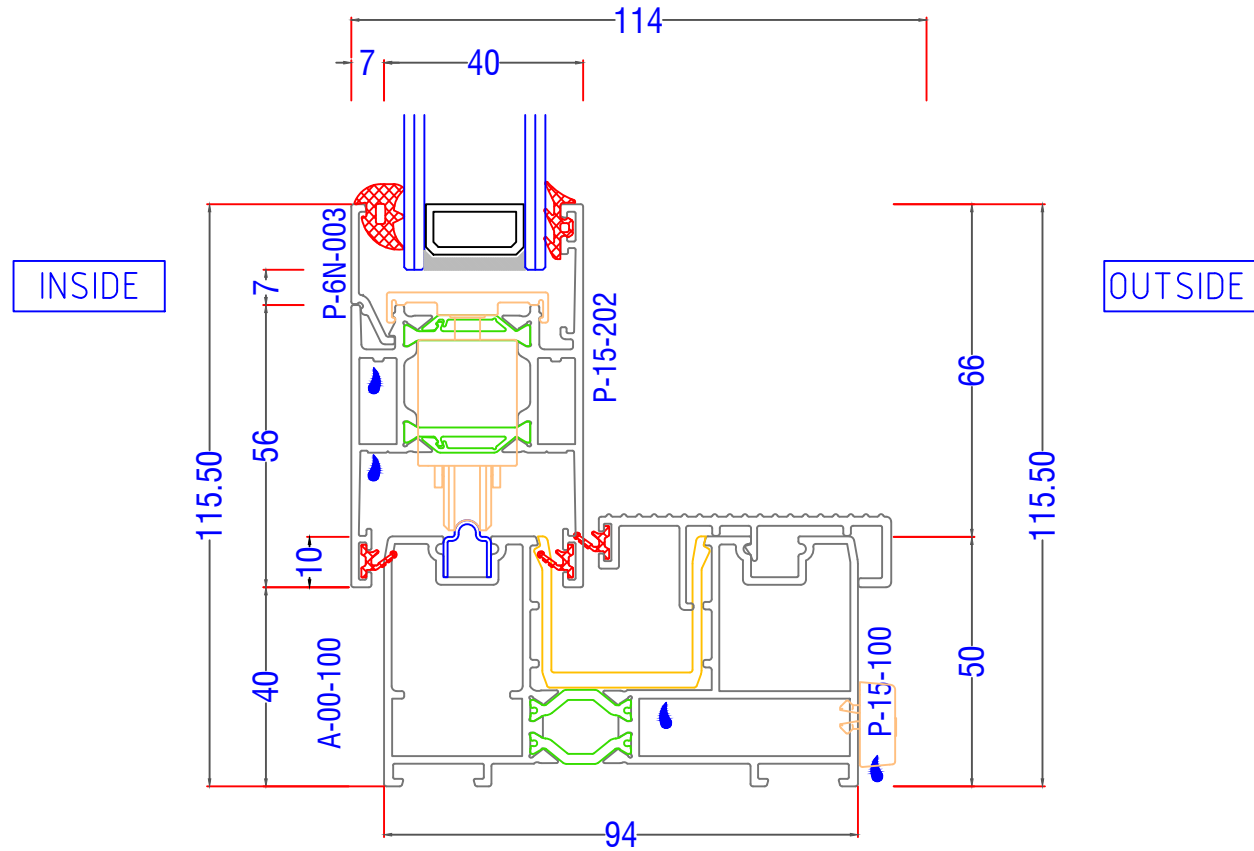

BSC 94 - Typical Sections

Tri Frame - Fixed Panel Threshold

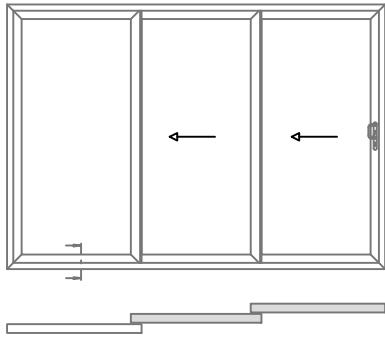

Tri Frame - Sliding Panel

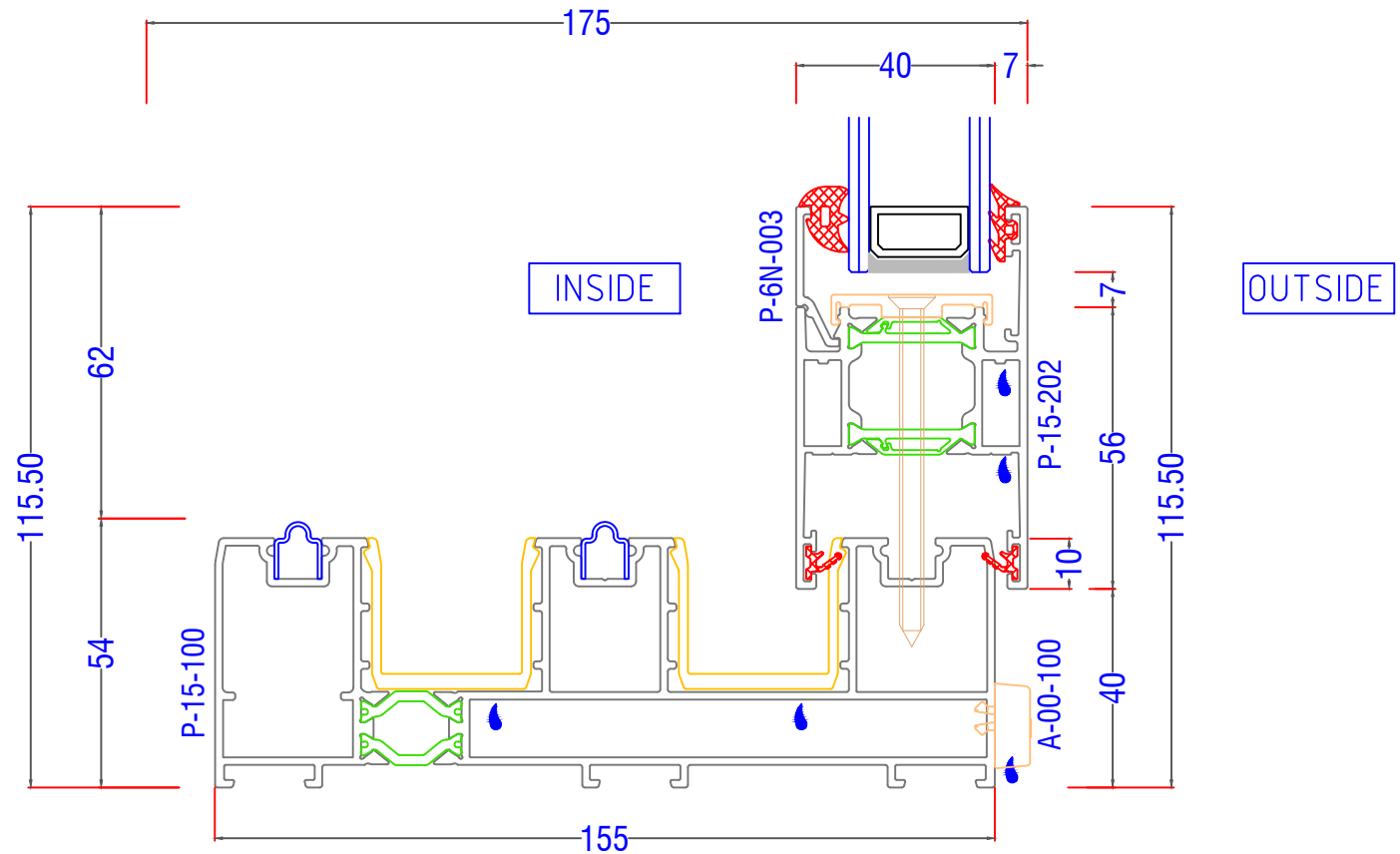

BSC 94 - Typical Sections

Tri Frame - Sliding Panel Threshold

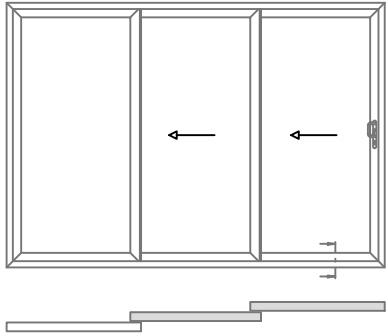

Tri Frame - Sliding Panel

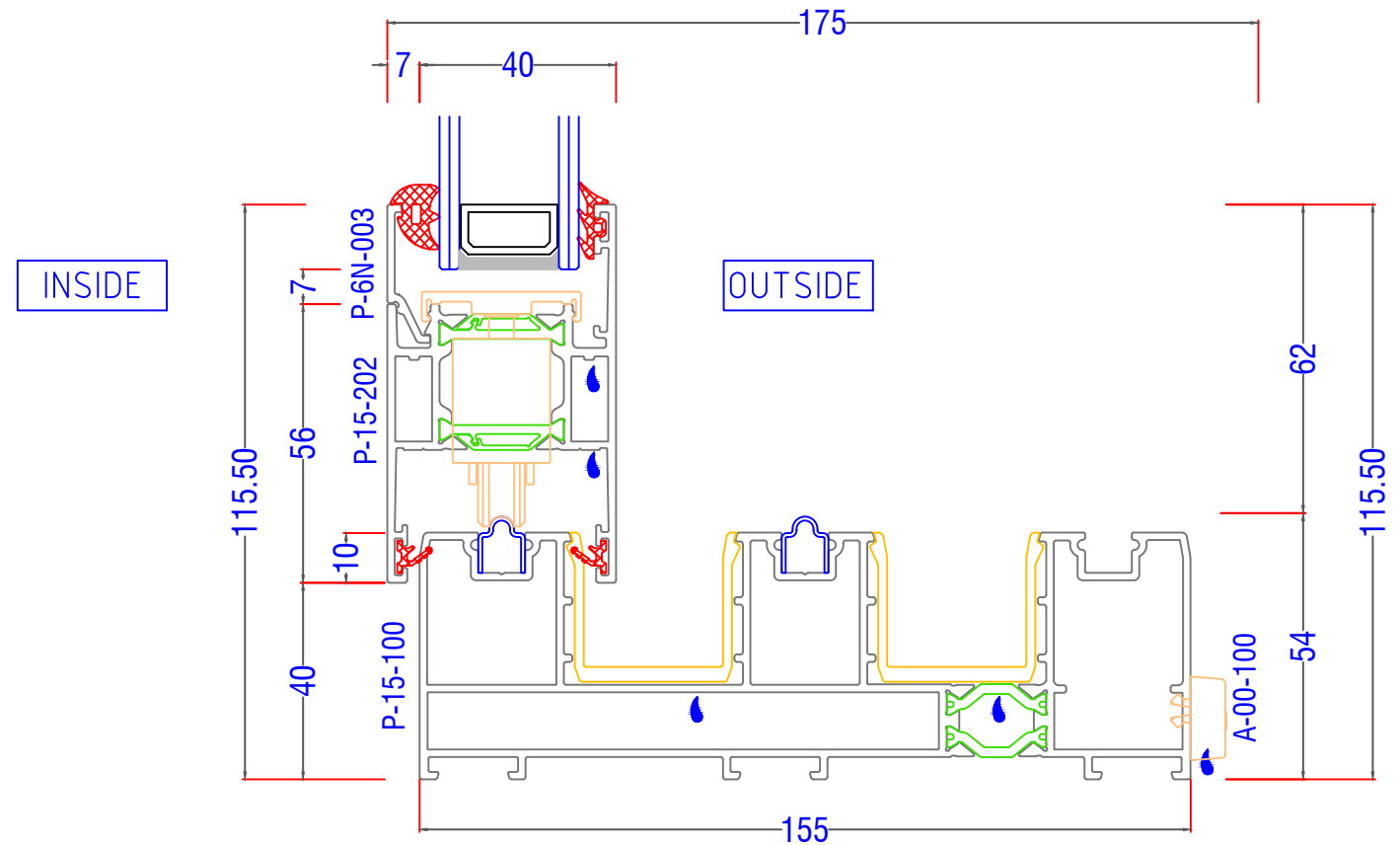

BSC 94 - Typical Sections

Duo Frame - Fixed Panel Head

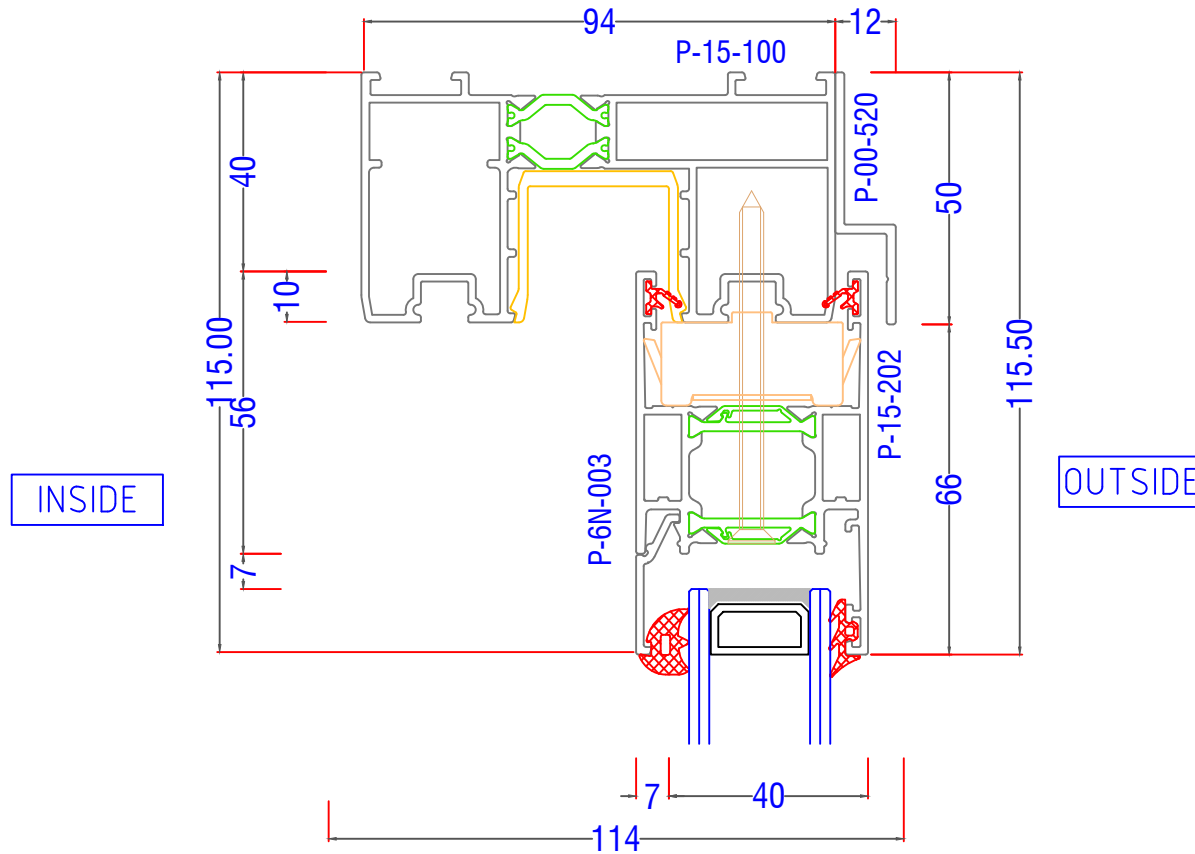
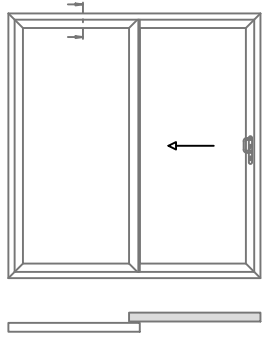

BSC 94 - Typical Sections

Duo Frame - Sliding Panel Head

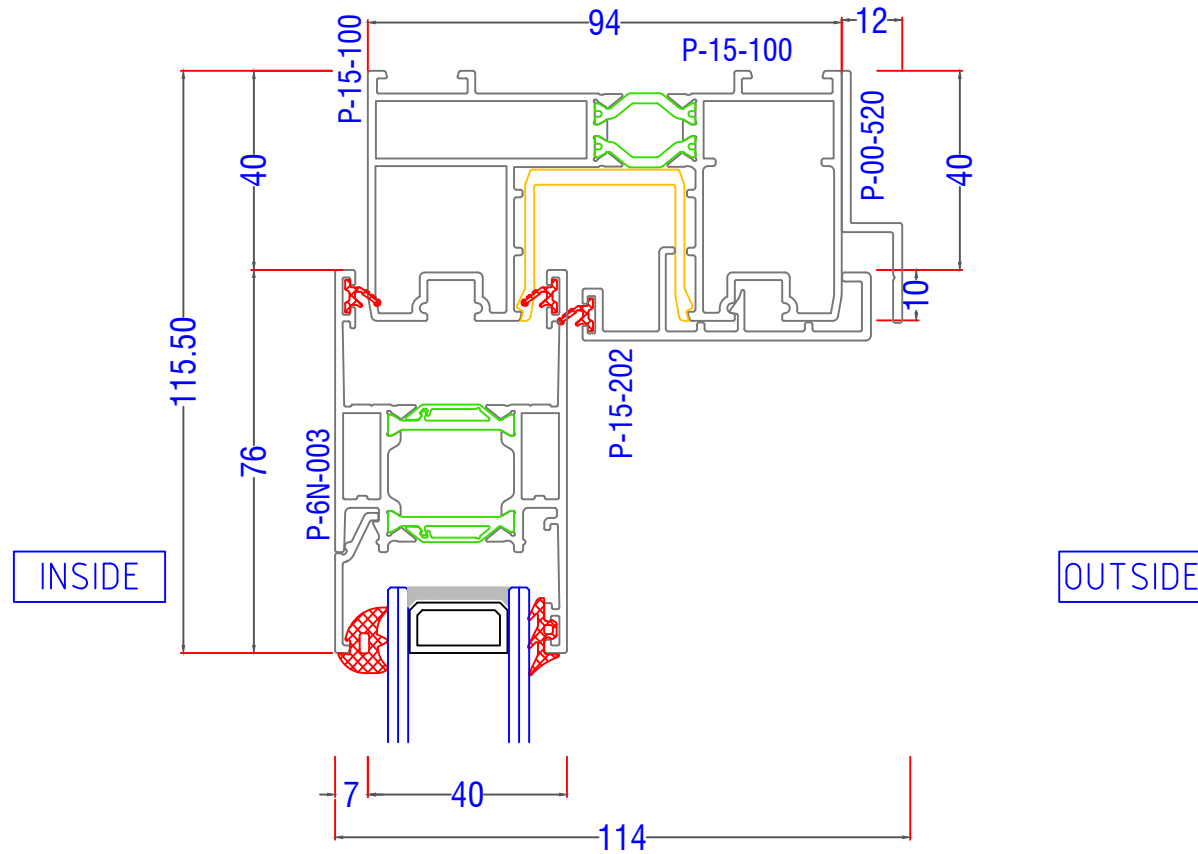
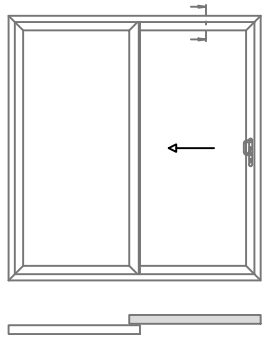

BSC 94 - Typical Sections

Tri Frame - Fixed Panel Head

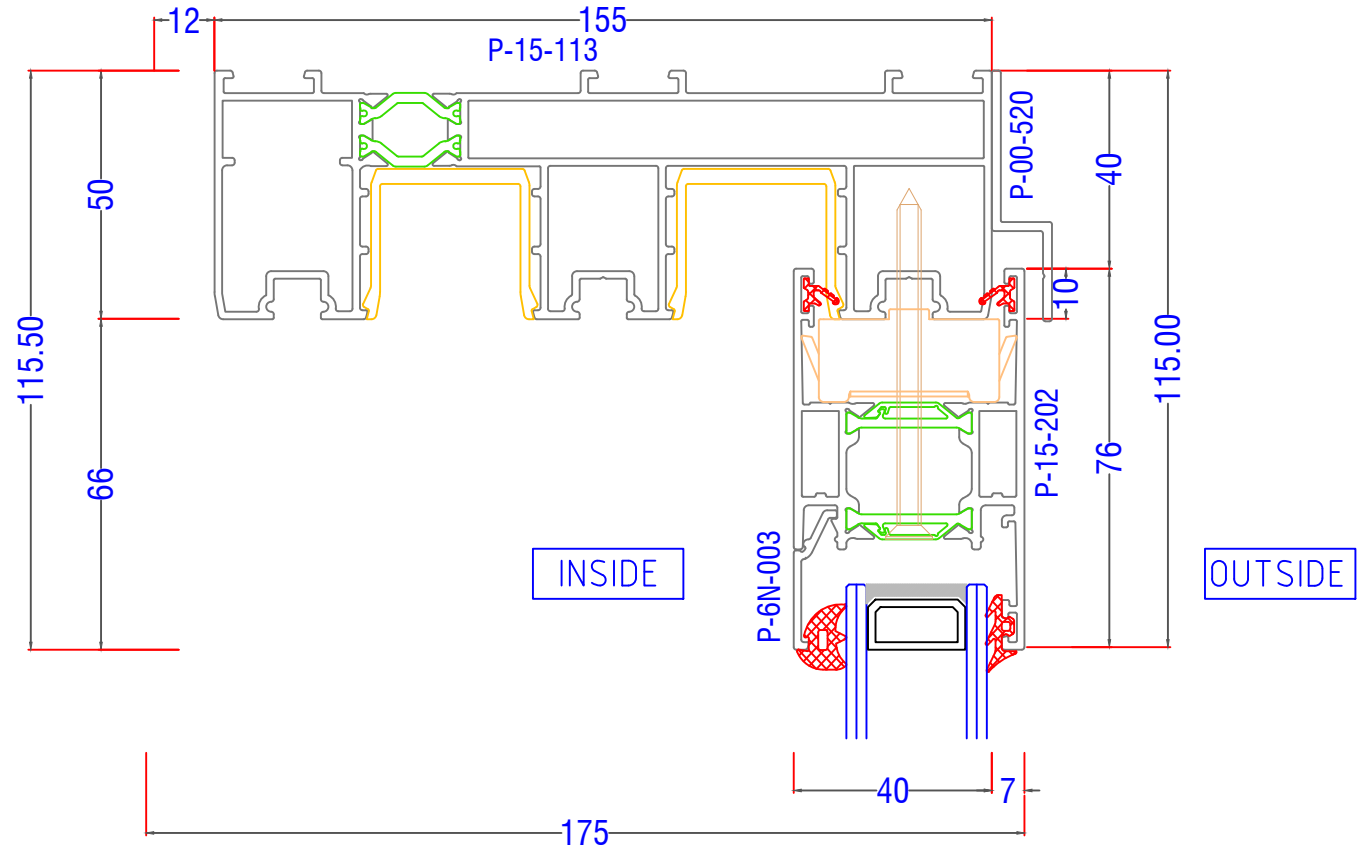
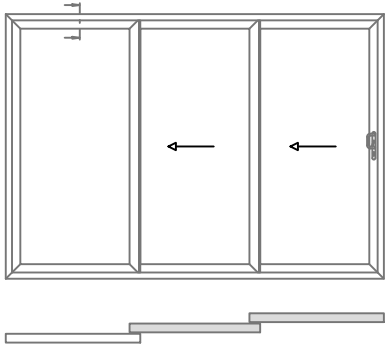

BSC 94 - Typical Sections

Tri Frame - Sliding Panel Head

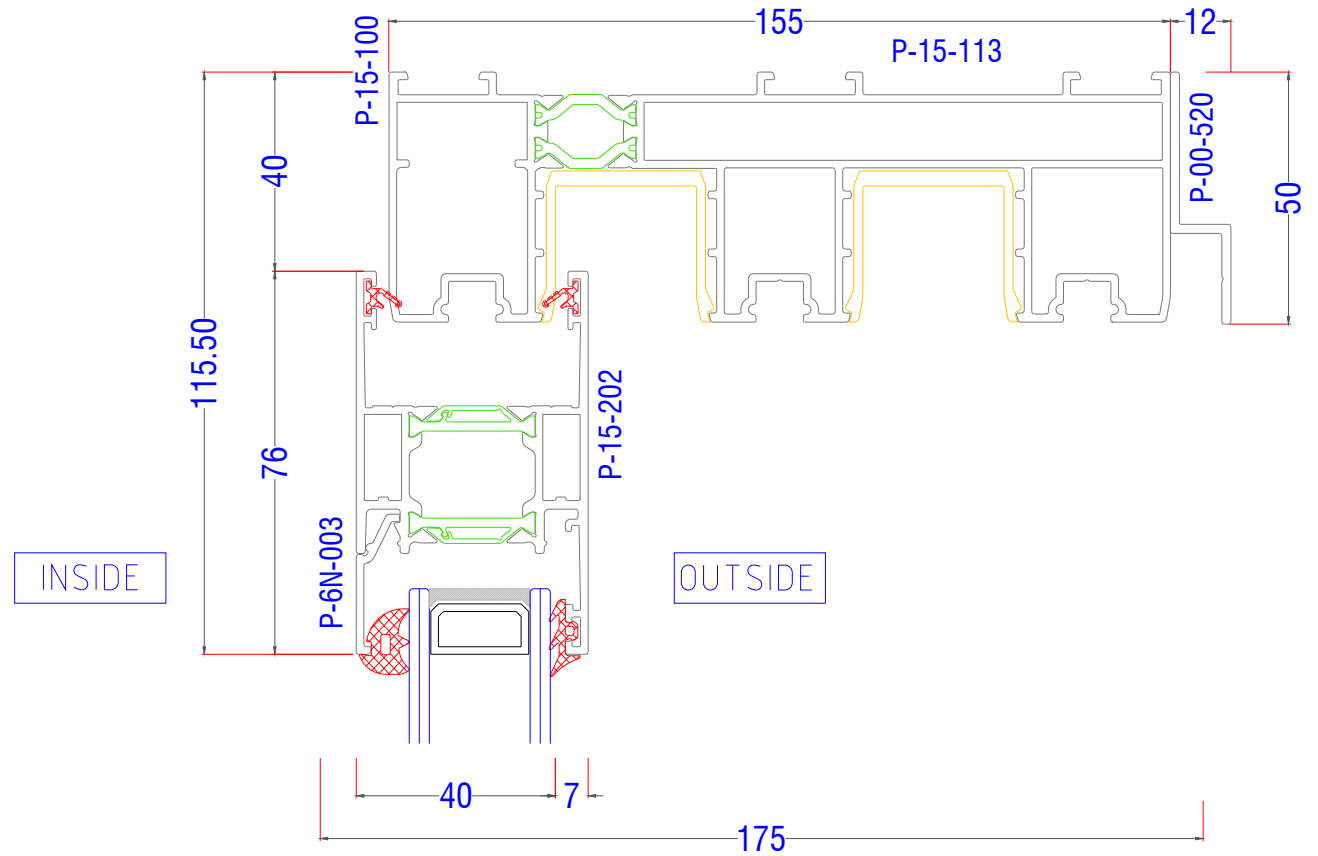
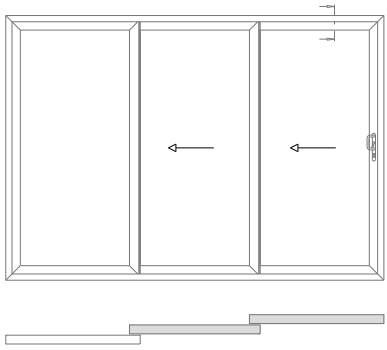

BSC 94 - Typical Sections

Interlock Standard - Standard

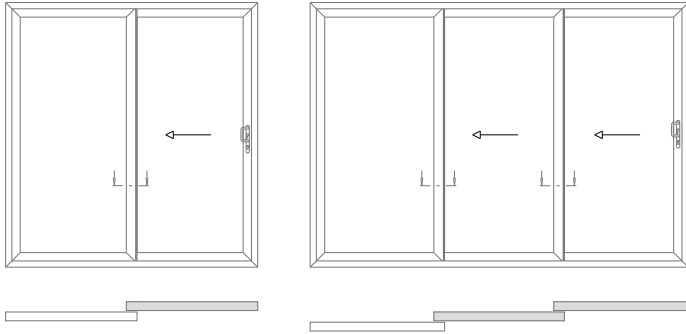

600Pa - Standard Interlock

Door Height	Door Panel Width / interlock Split (mm)															
	500	600	700	800	900	1000	1100	1200	1300	1400	1500	1600	1700	1800	1900	2000
1800																
1900																
2000																
2100																
2200																
2300																
2400																
2500																
2600																
2700																
2800																
2900																
3000																

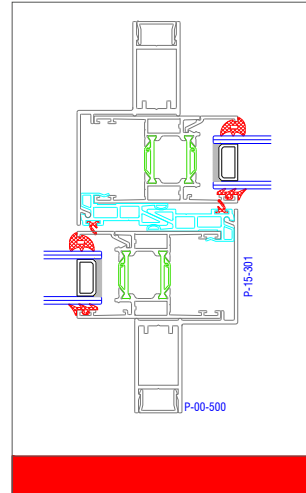
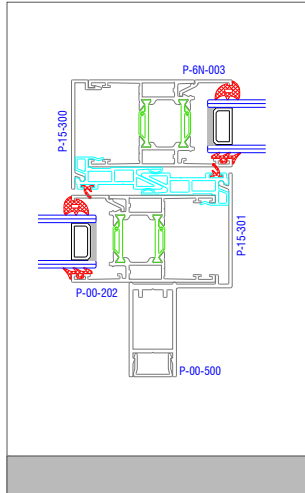
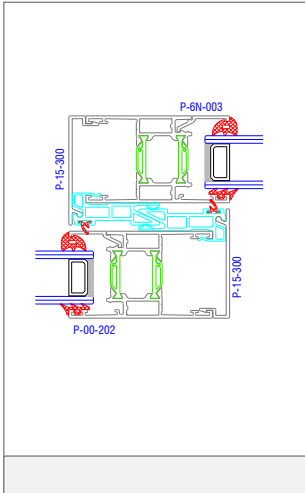

800Pa - Standard Interlock

Door Height	Door Panel Width / interlock Split (mm)															
	500	600	700	800	900	1000	1100	1200	1300	1400	1500	1600	1700	1800	1900	2000
1800																
1900																
2000																
2100																
2200																
2300																
2400																
2500																
2600																
2700																
2800																
2900																
3000																

BSC 94 - Typical Sections

Interlock Standard - Standard

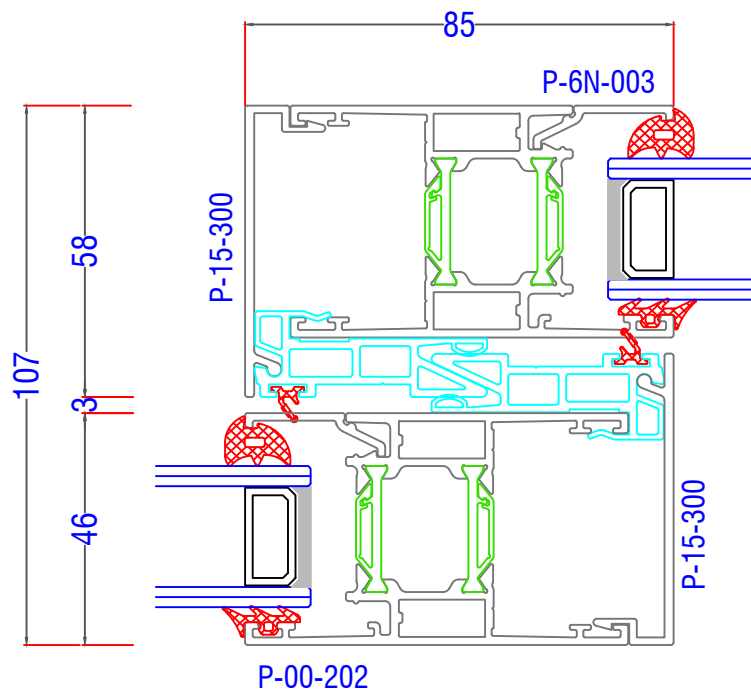
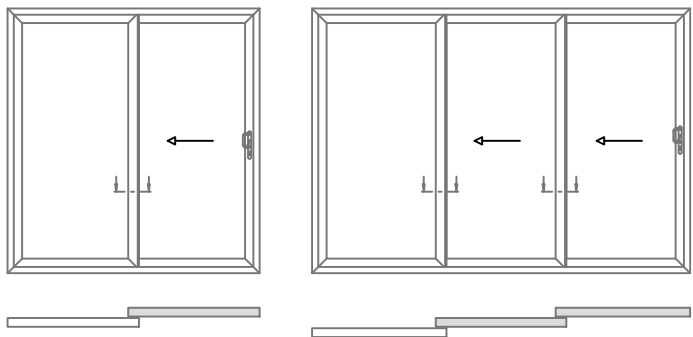

BSC 94 - Typical Sections

Interlock Standard - Reinforced Profile Outside Only

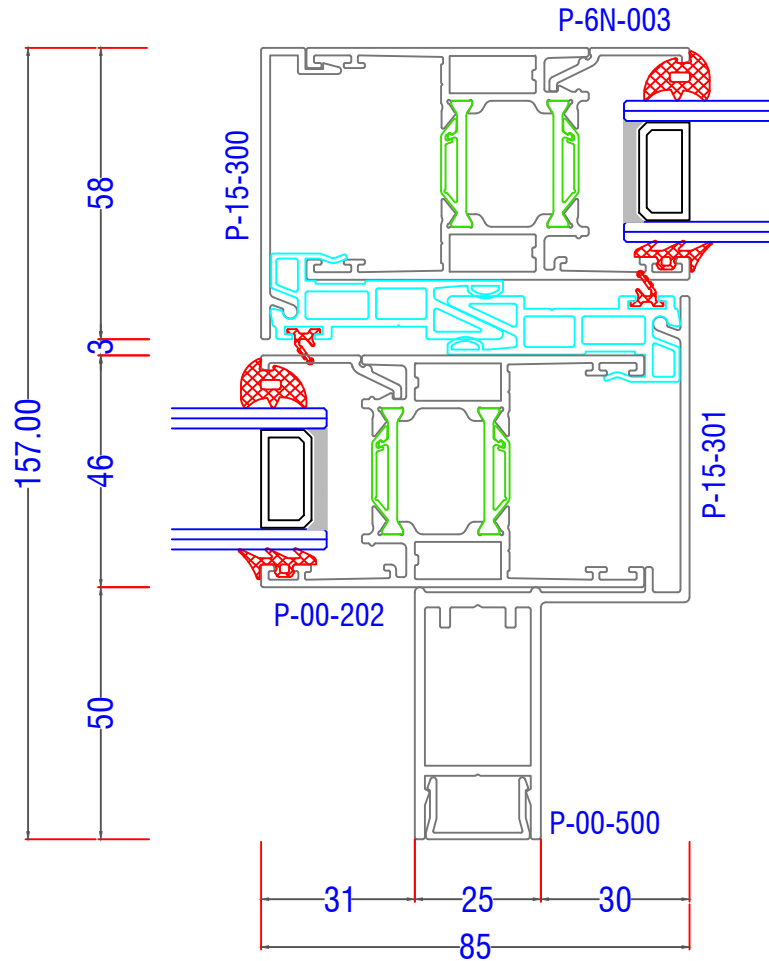
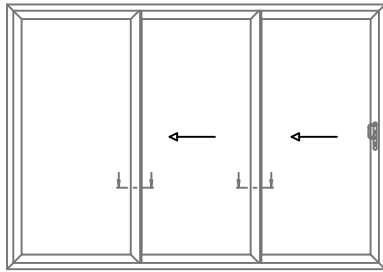
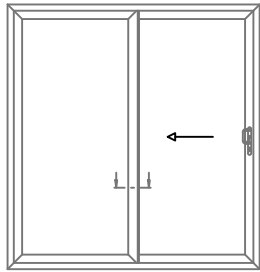

BSC 94 - Typical Sections

Interlock Standard - Reinforced Profile Inside and Outside

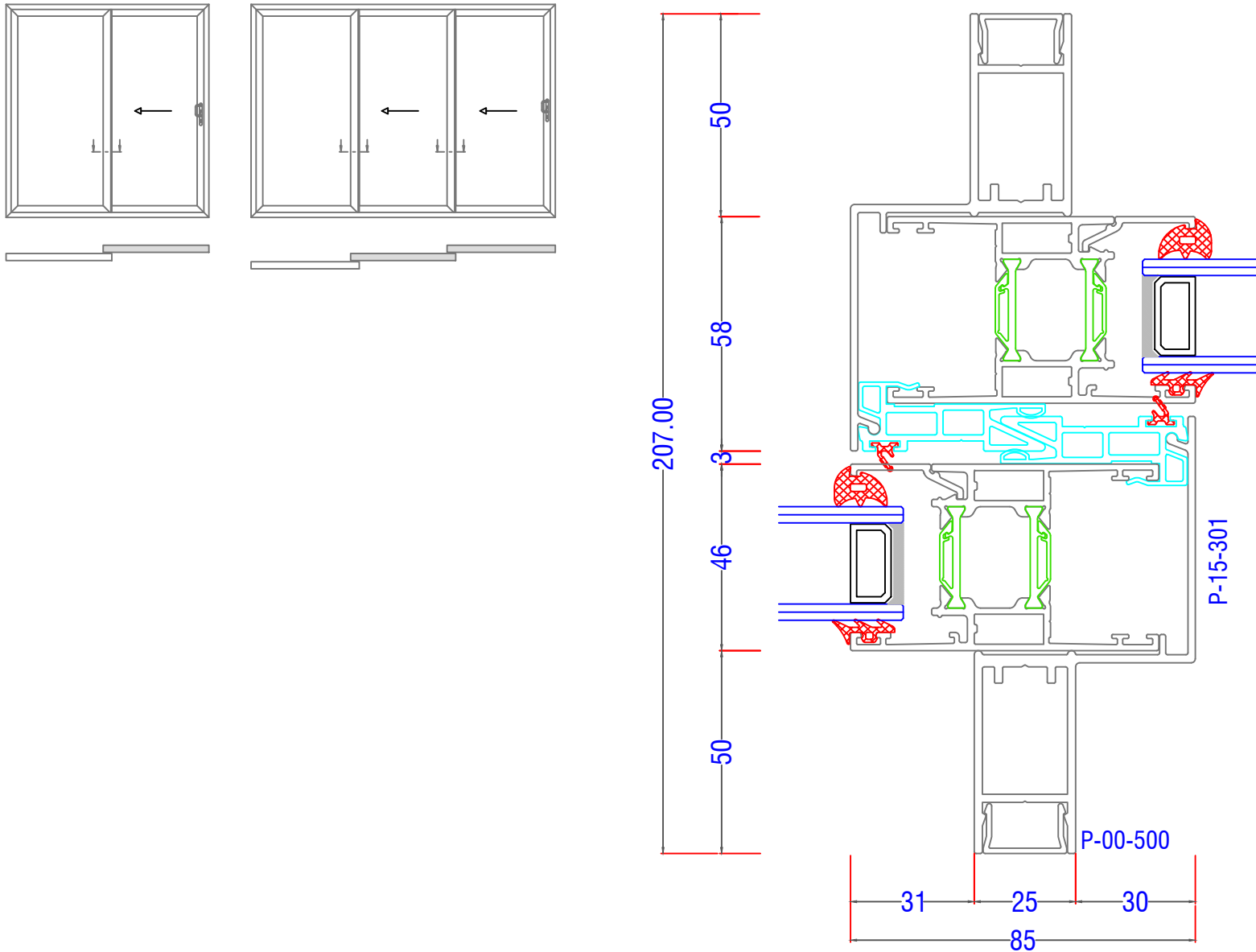

BSC 94 - Typical Sections

Interlock Standard - Standard

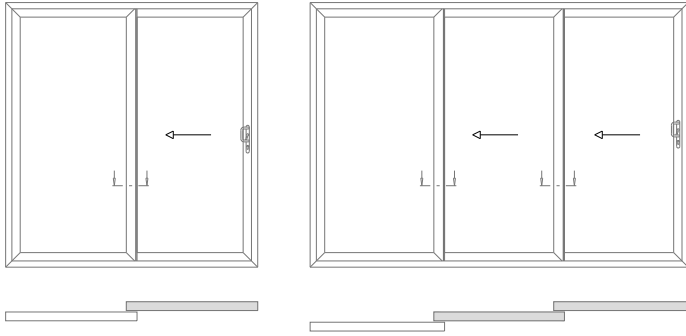

600Pa - Slim Interlock

Door Height	Door Panel Width / interlock Split (mm)															
	500	600	700	800	900	1000	1100	1200	1300	1400	1500	1600	1700	1800	1900	2000
1800																
1900																
2000																
2100																
2200																
2300																
2400																
2500																
2600																
2700																
2800																
2900																
3000																

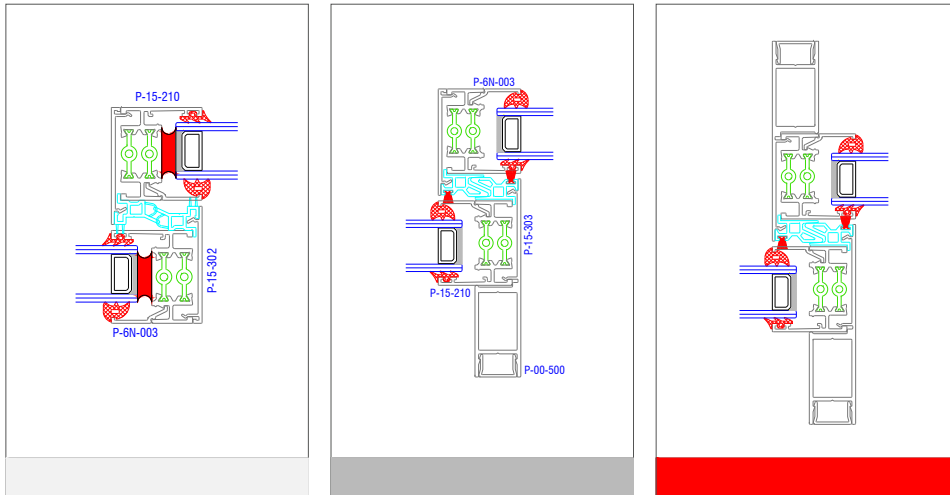

800Pa - Slim Interlock

Door Height	Door Panel Width / interlock Split (mm)															
	500	600	700	800	900	1000	1100	1200	1300	1400	1500	1600	1700	1800	1900	2000
1800																
1900																
2000																
2100																
2200																
2300																
2400																
2500																
2600																
2700																
2800																
2900																
3000																

BSC 94 - Typical Sections

Interlock Slim - Standard

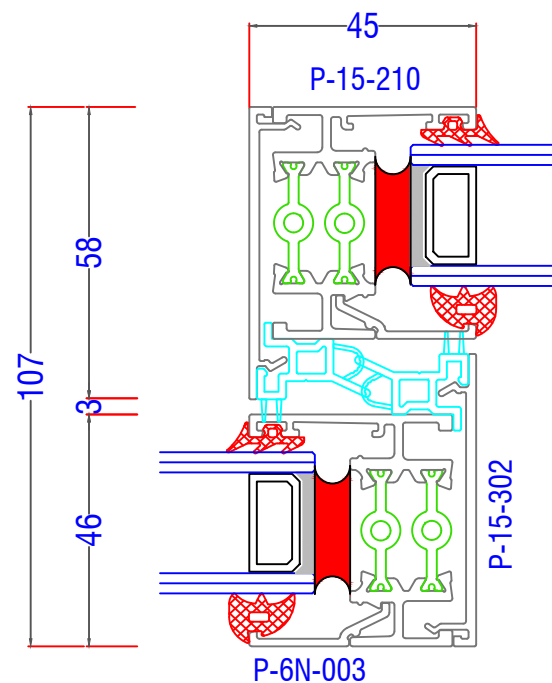
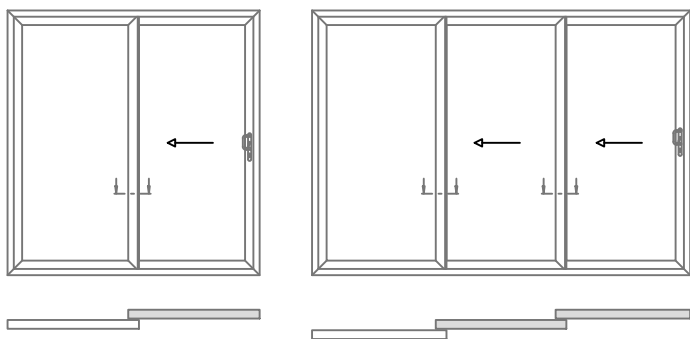

BSC 94 - Typical Sections

Interlock Slim - Reinforced Profile Outside Only

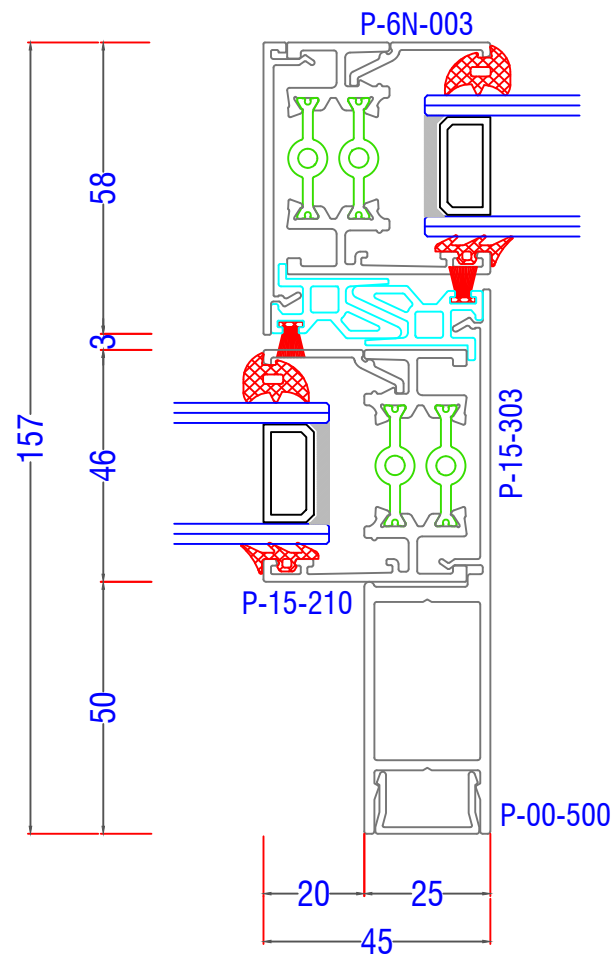
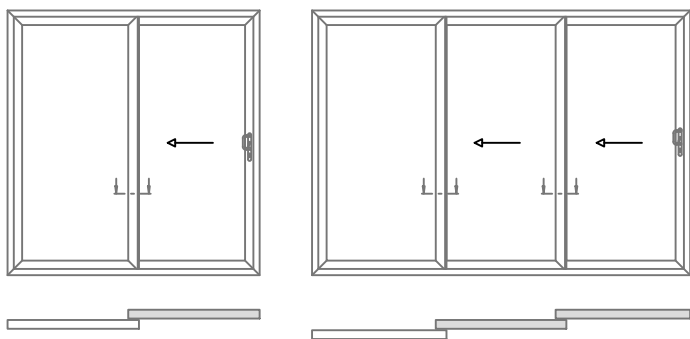

BSC 94 - Typical Sections

Interlock Slim - Reinforced Profile Inside and Outside

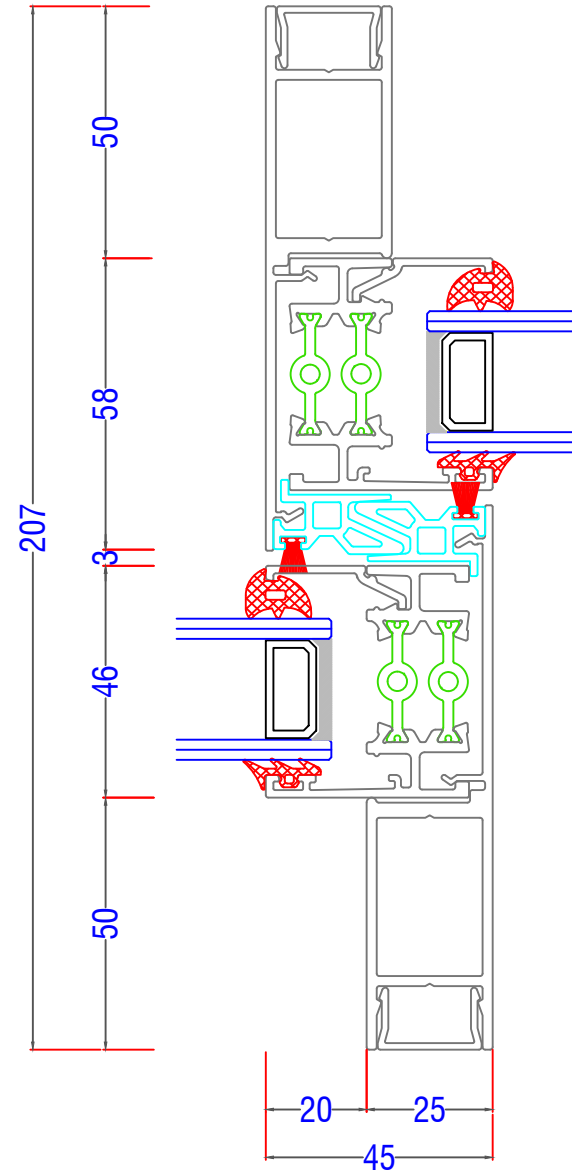
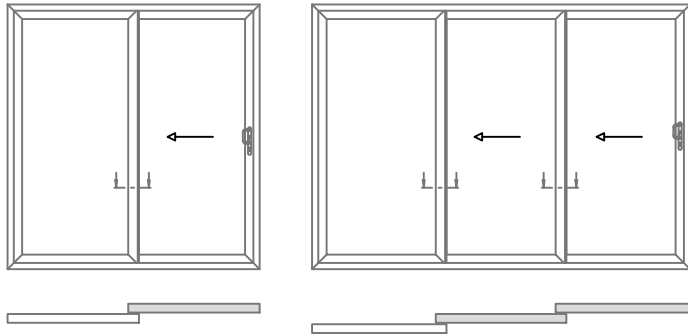

BSC 94 - Typical Sections

Meeting Profile

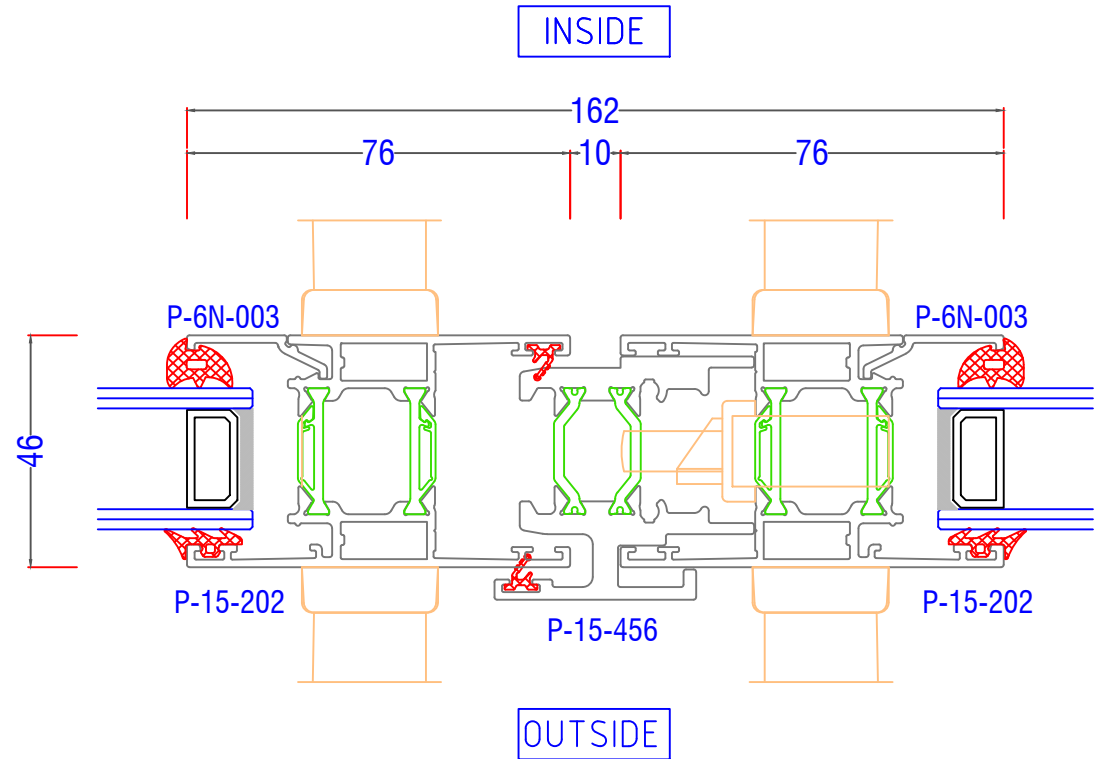
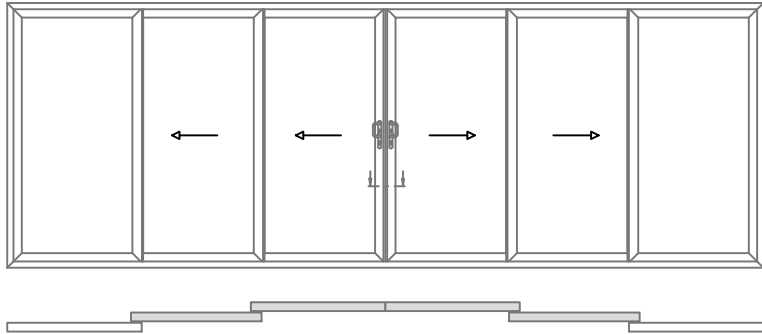
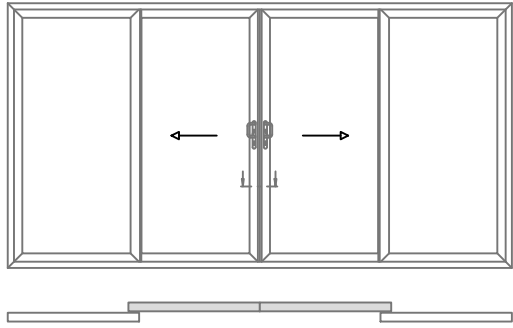

BSC 94 - Typical Sections

Duo Frame - Cill Options

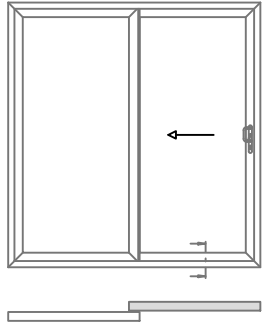

INSIDE

OUTSIDE

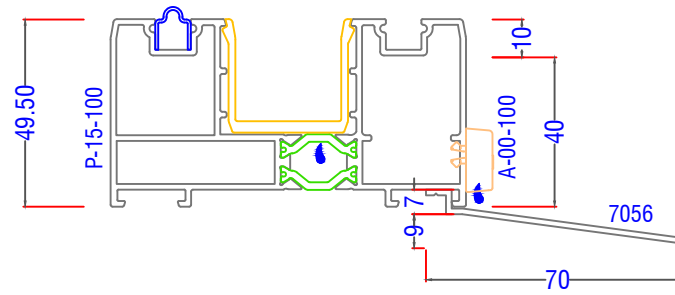
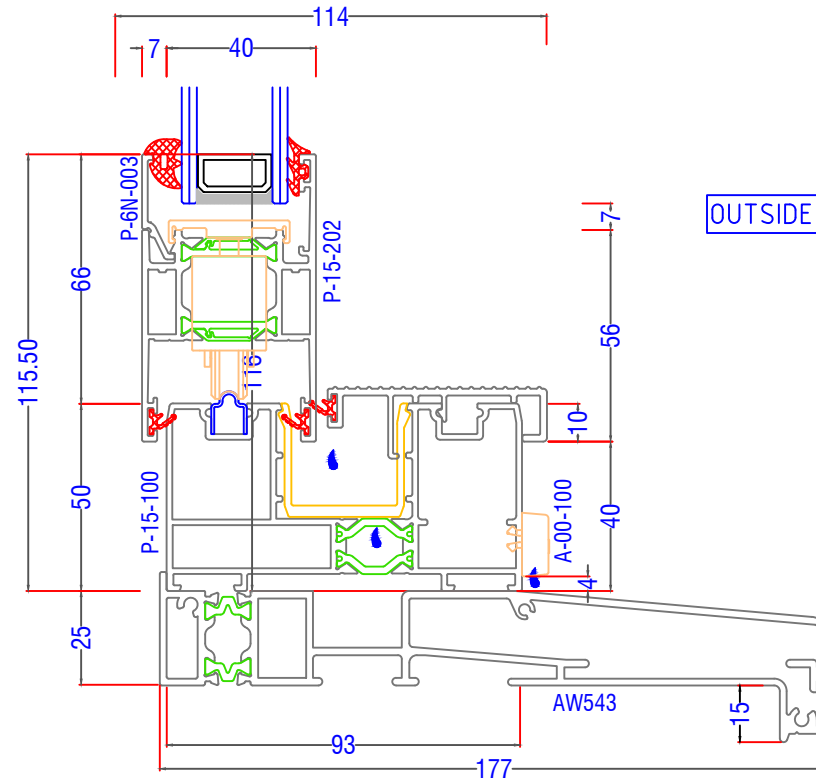

BSC 94 - Typical Sections

Duo Frame - Cill Options

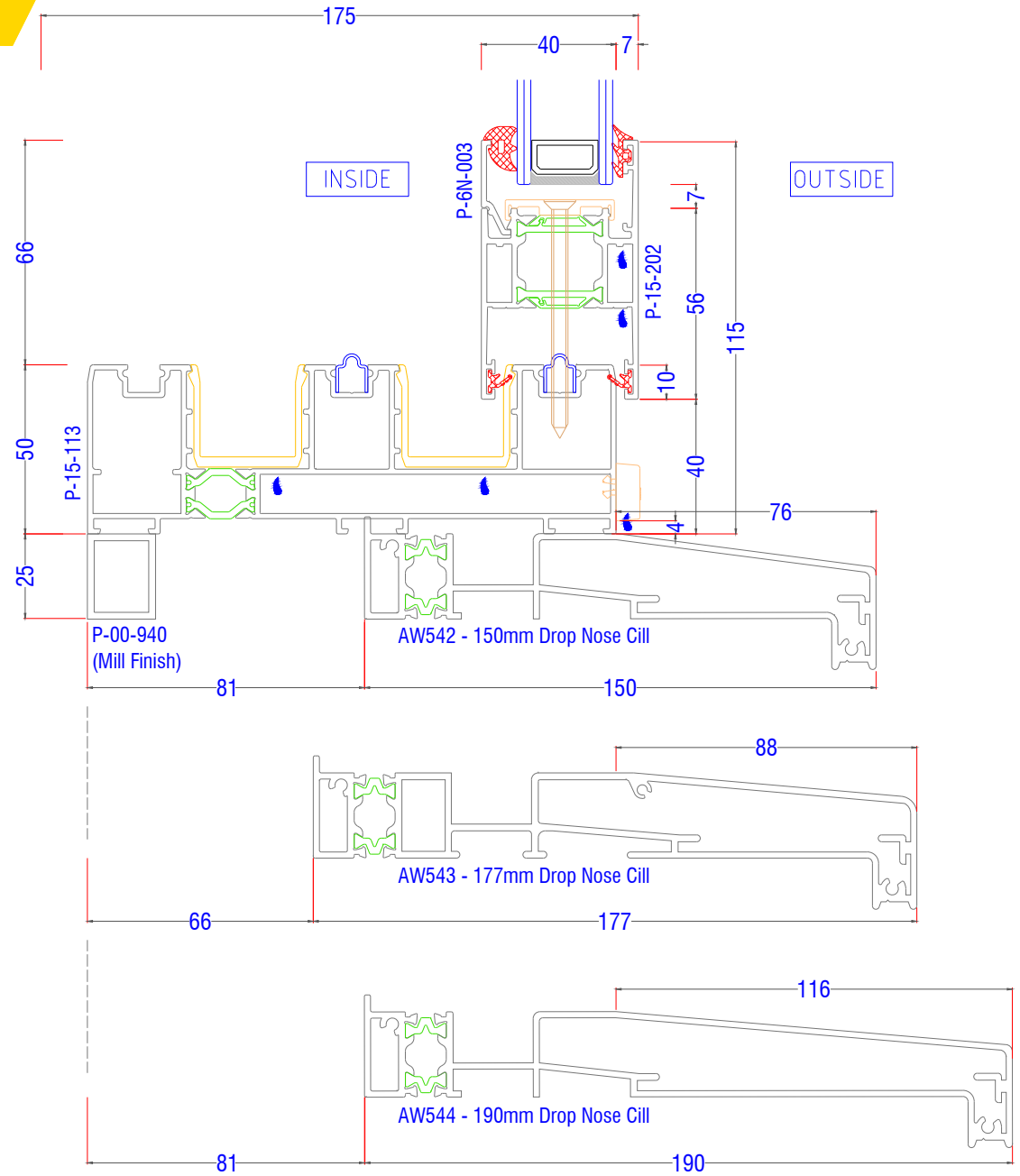
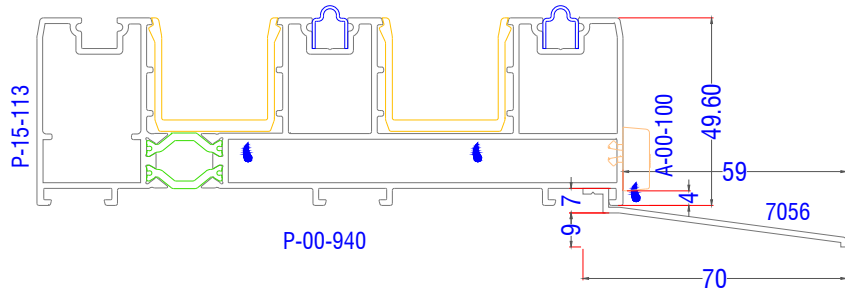
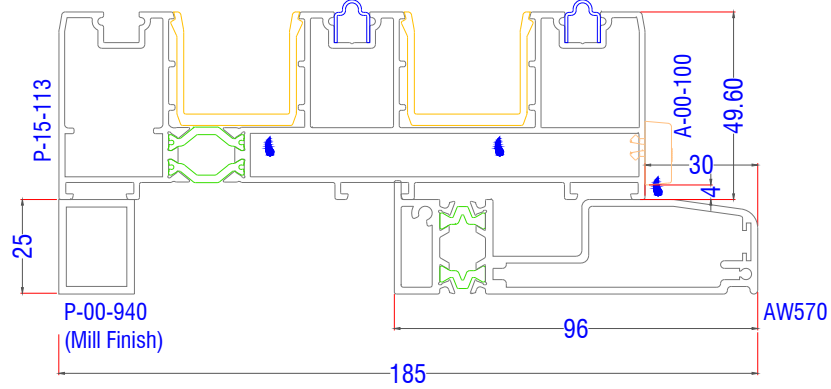
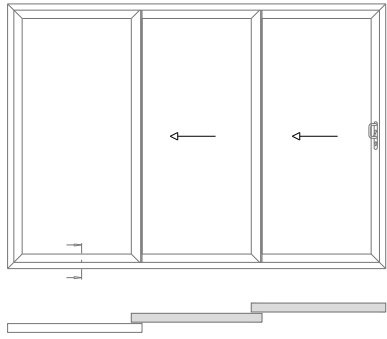

BSC 94 - Typical Sections

Duo / Tri Frame - Frame Extender + Trickle Vent

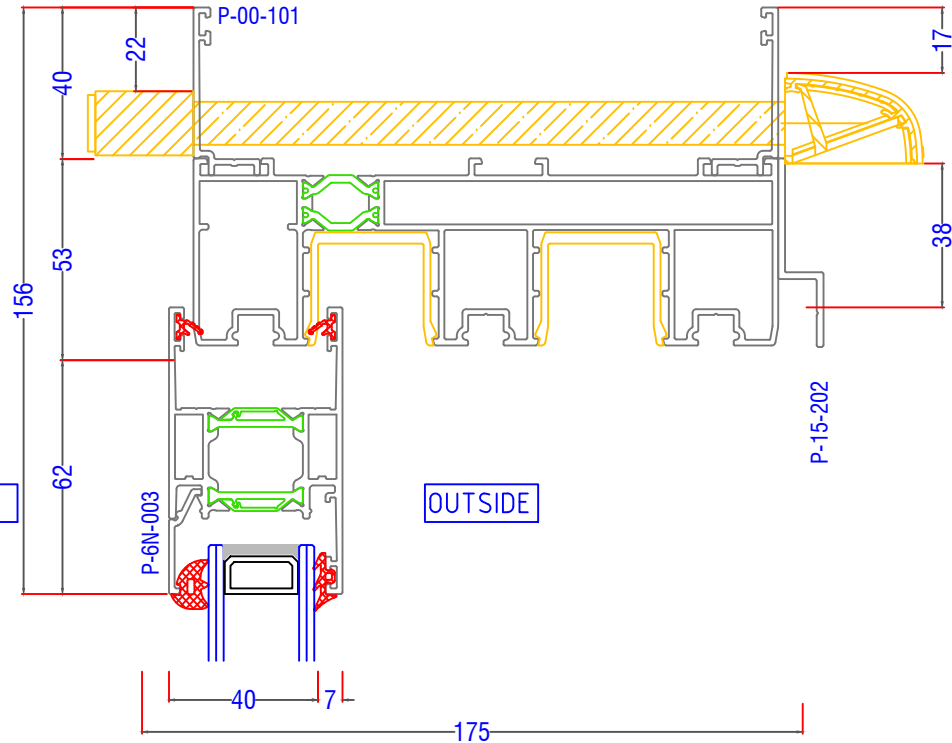
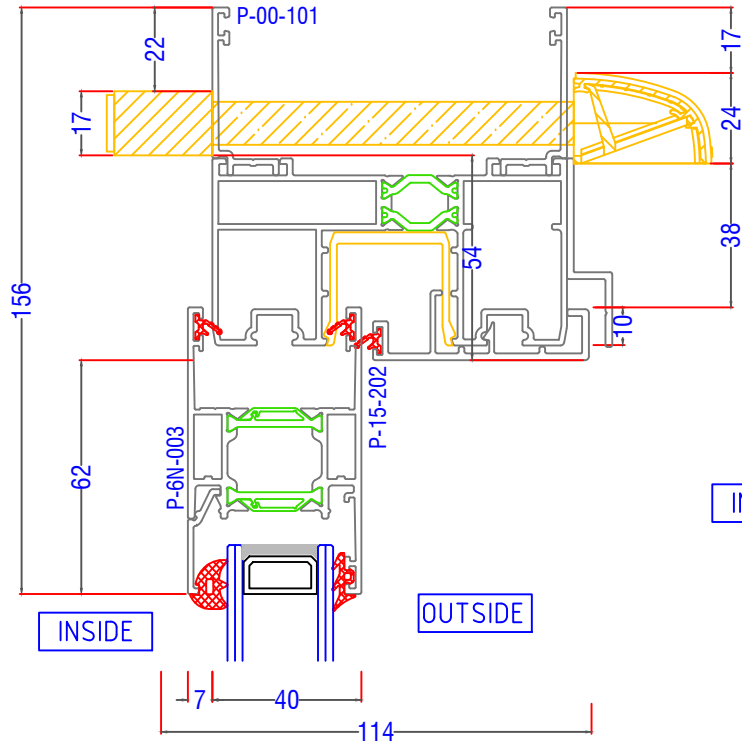
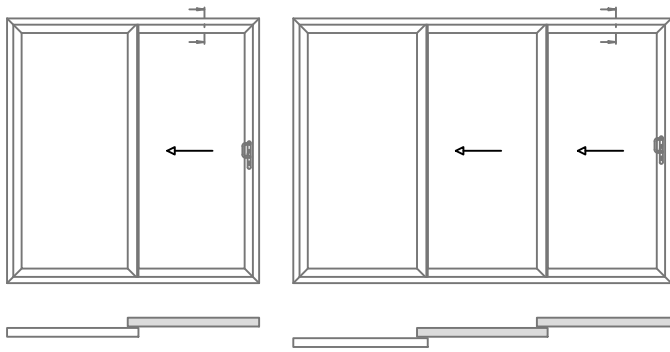



Glass & Glazing Federation Member

Official Police Security Initiative

Arkay Windows is a specialist large-scale fabricator with over 30 years experience based in Watford, North West London.

Through growth built on putting our customers first, we have risen to supply some of the country's biggest retail companies, contractors and commercial installers.

 **Arkay Windows**

Watford: 01923 803923
London: 020 8889 6821

sales@arkaywindows.com
www.arkaywindows.com

