



**Arkay Windows**

**TECHNICAL DOCUMENTS**

**ALUK 58 BW TBT**

# ALUK 58 BW TBT

Z:\Aluminium\Brochures\Arkay\PDF Images\ALUK 58 BW - Product Sheet - Digital.0bb91753.png



## HIGH PERFORMANCE SOLUTION

**An effective and high performance solution** - offering clean lines and advanced functionality for both new build and residential replacement applications. This window system is available in a range of configurations from Casement, tilt-before-turn and top-swing-reverse.

### DESIGN FEATURES

- Certified under the Secured By Design scheme
- Tested to PAS 24
- Green guide rated A
- Integrated deep head profiles for ease of trickle ventilation
- Unique polamide thermal break design to improve thermal performance

### OPTIONS

- 58mm frame depth
- Project in or project out options
- Internally or externally glazed to accommodate low and high rise projects
- Glazing 24mm - 40mm
- Available in a range of single or dual colour and anodised finishes
- Available for Lifetime Homes (LFT)

### Size Limits

	CASEMENT	TBT	TSR
Top hung (max weight)	180kg	-	-
Tilt before turn (max weight)	-	100kg	-
Side hung (max weight)	55kg	100kg	-
Bottom hung (max weight)	60kg	-	-
Top swing (max weight)	-	-	60kg
Side swing (max weight)	-	-	45kg
Fixed light (max weight)	250kg	250kg	250kg

D:\aluk\Brochures\Arkay\PDF Images\ALUK 58 BW - Product Sheet - Digital.0bb91753.png

	CASEMENT	TBT	TSR
FRAME DEPTH	58mm	58mm	58mm
DUAL COLOUR OPTION	☐	☐	☐
MULTI-POINT LOCKING	☐	☐	☐
GLAZING OPTIONS	Internal and External Bead	Internal and External Bead	Internal Bead
GLAZING THICKNESS	24mm - 40mm	24mm - 40mm	24mm - 28mm
SIGHTLINE (FRAME TO VENT)	75mm	86mm	103mm
SIGHTLINE (VENT TO MULLION)	89mm	100mm	161mm
SIGHTLINE (FIXED LIGHT)	43mm	43mm	-

PERFORMANCE	CASEMENT	TBT	TSR
U-VALUE (DOUBLE GLAZING)	1.4 W/m²K	1.5 W/m²K	1.7 W/m²K
U-VALUE (TRIPLE GLAZING)	1.2 W/m²K	1.3 W/m²K	-
WINDOW ENERGY RATING	B - C	B - C	-
GREEN GUIDE RATING	A Rated	A Rated	A Rated
ACOUSTIC PERFORMANCE	Rw (C;Ctr) 42 (-1;-5) dB	Rw (C;Ctr) 44 (-1;-4) dB	-
AIR TIGHTNESS	Class 4	Class 4	Class 4
WATER TIGHTNESS	Class 9A	Class 9A	Class 9A
WIND LOAD	Class E2400	Class E2400	Class A5
SECURITY	PAS 24	PAS 24	PAS 24
3RD PARTY CERTIFICATION	Q-mark	Q-mark	Q-mark
SECURED BY DESIGN	Yes	Yes	Yes

# ALUK 58 BW TBT- Contents

- 1.0 Typical Elevations
- 2.0 Standard Profiles
- 3.0 Typical Sections
  - 3.1 Fixed Jamb
  - 3.2 Open Out Jamb
  - 3.3 Fixed Head
  - 3.4 Open Out Head
  - 3.5 Head Detail with Trickle Vent
  - 3.6 Base Cill Details:
    - 3.6a 95mm Stub Cill
    - 3.6b 150mm Drop Nose Cill
    - 3.6c 190mm Drop Nose Cill
  - 3.7 Coupling Bars:
    - 3.7a Concealed Coupler
    - 3.7b 25/15 Coupler
    - 3.7c 36/26 Coupler
  - 3.8 Fixed - Open Mullion
  - 3.9 Open - Open Mullion
  - 3.10 Fixed - Fixed Transom
  - 3.11 Fixed - Open Transom
  - 3.12 Open - Open Transom
  - 3.13 Bay Window Baypole / 90° Corner Post
  - 3.14 Frame Extender

# 58BW TBT - Elevation

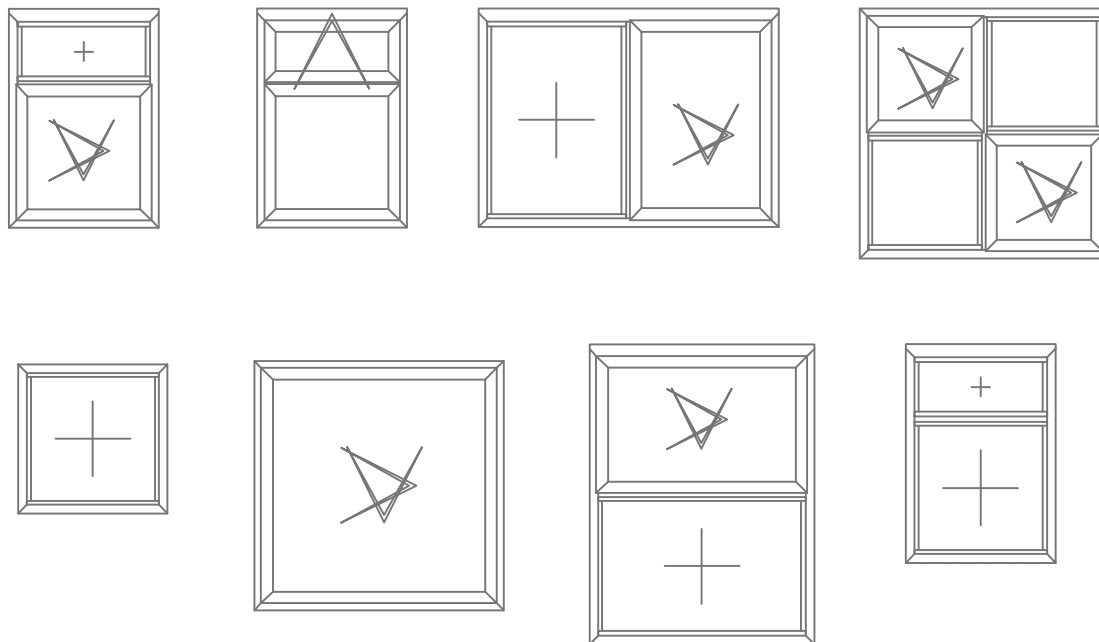

# AL UK 58BW TBT - Standard Profiles

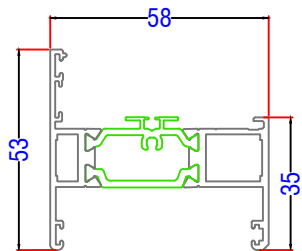

AL UK AW605 - Outer Frame

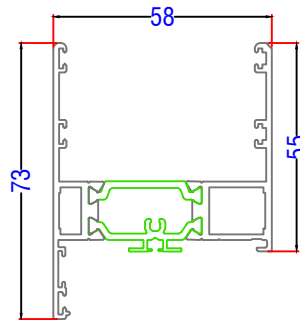

AL UK AW608 - Outer Frame

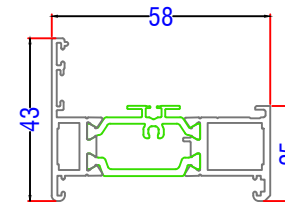

AL UK AW604 - Outer Frame

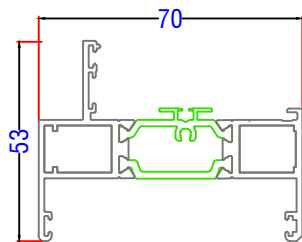

ALU UK AW622 - Outer Frame

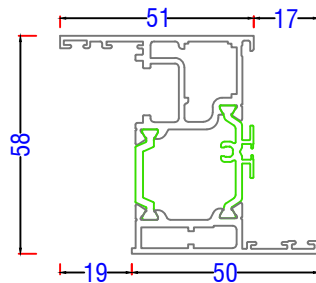

AL UK AW621 - Vent

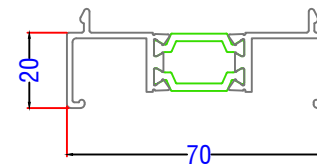

AL UK AW724 - Frame Extender

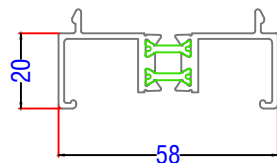

AL UK AW725 - Frame Extender

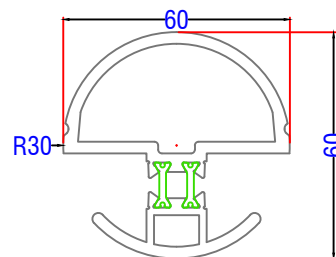

AL UK AW712 - Baypole

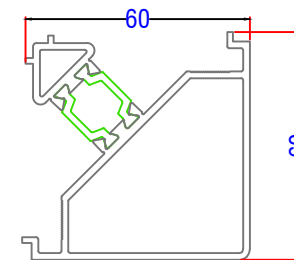

AL UK AW721 - Baypole

# AL UK 58BW TBT - Standard Profiles

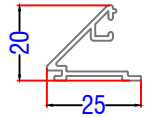

AL UK AW513 - Chamfered Glazing Bead

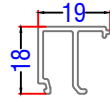

AL UK AW683 - Square Glazing Bead

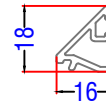

AL UK AW682 - Chamfered Glazing Bead

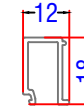

AL UK AW663 - Flat Glazing Bead

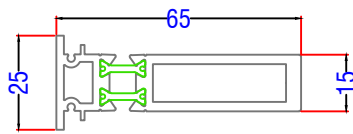

AL UK AW703 - Coupling Bar

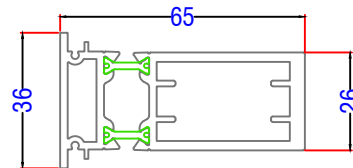

AL UK AW706 - Coupling Bar

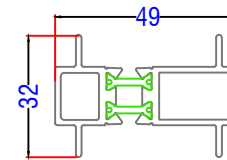

AL UK AW710 - Coupling Bar

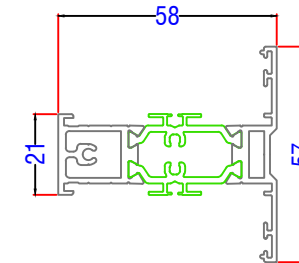

AL UK AW631 - Mullion/Transom

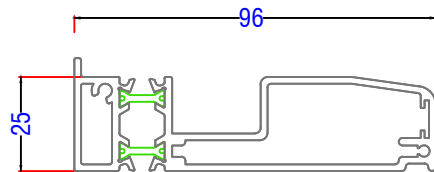

AL UK AW570 - 95mm Stub Cill

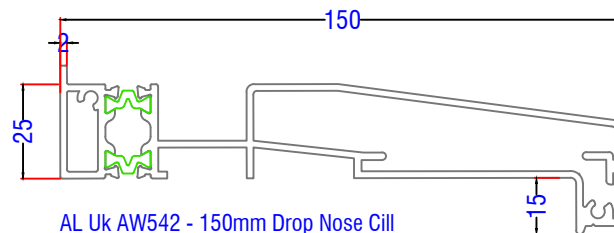

AL UK AW542 - 150mm Drop Nose Cill

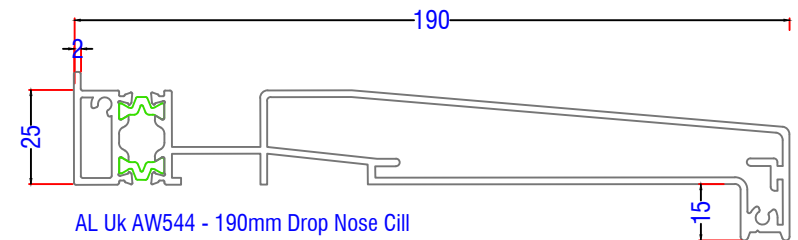

AL UK AW544 - 190mm Drop Nose Cill

# AL UK 58BW TBT - Fixed jamb

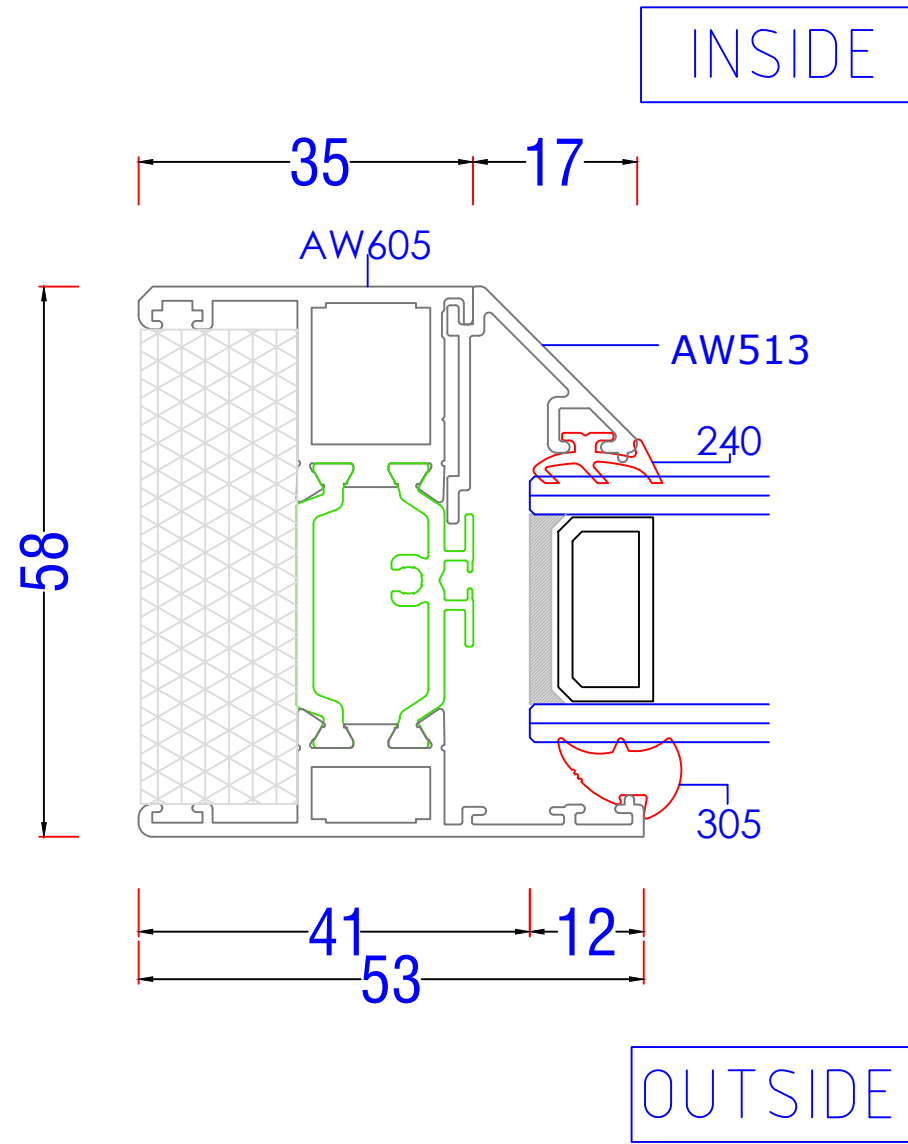
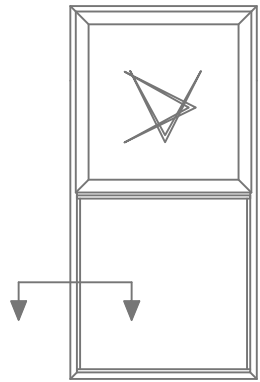

# AL UK 58BW TBT - Fixed head

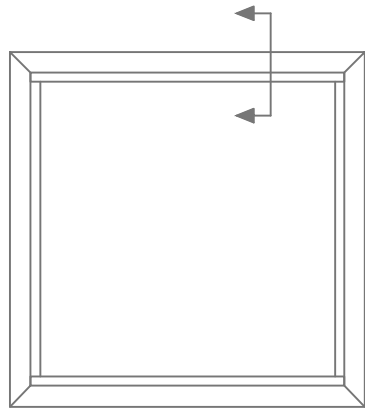

OUTSIDE

INSIDE

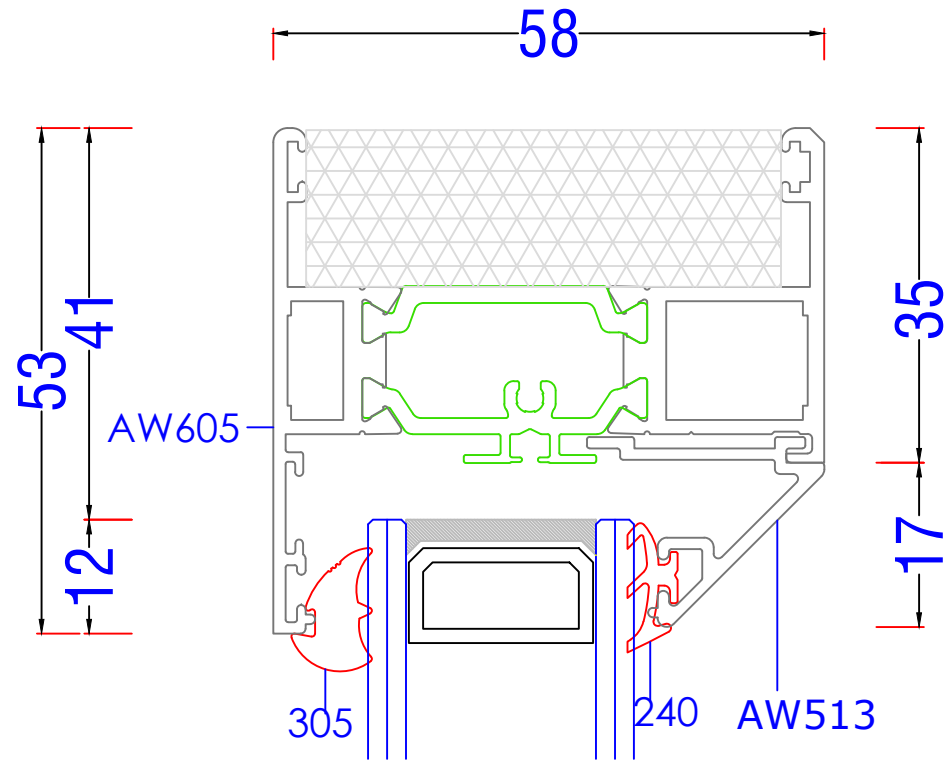



# AL UK 58BW - Open Out Head

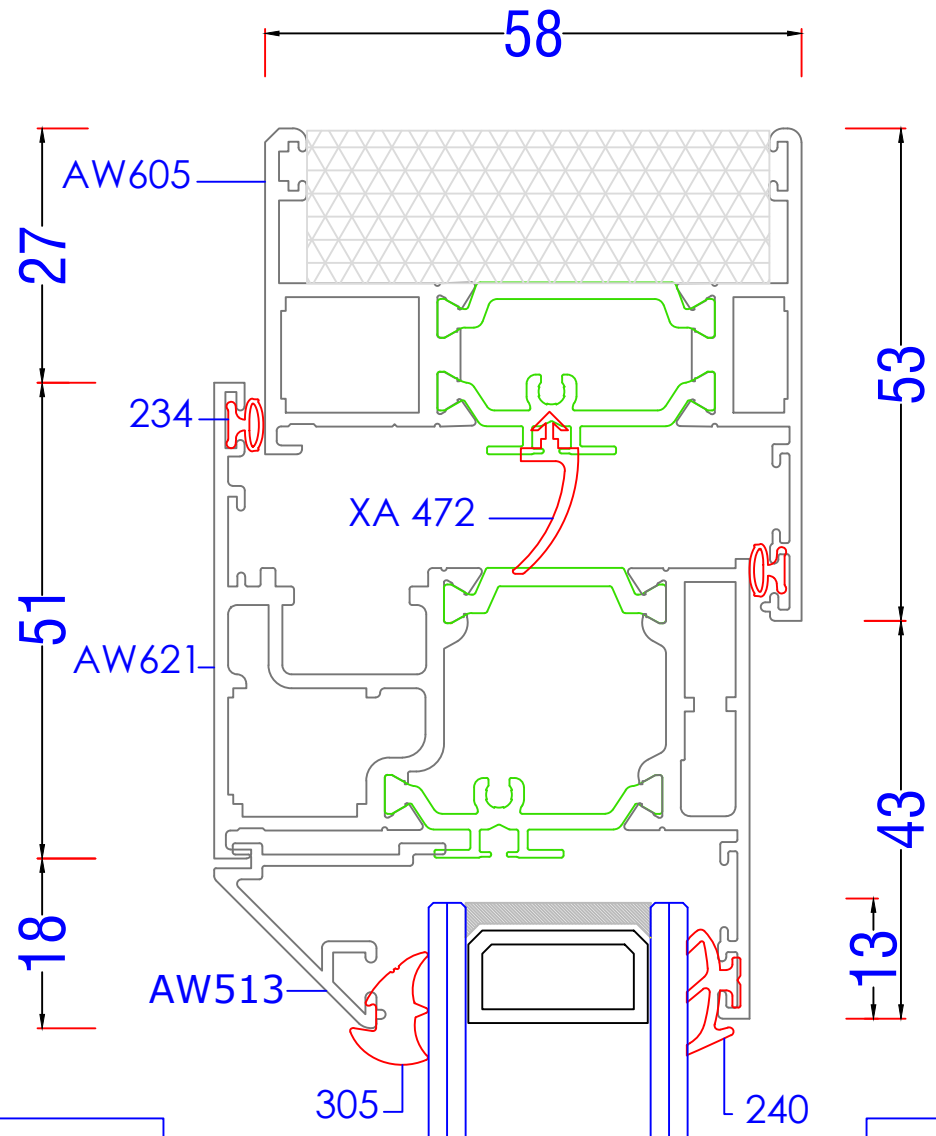
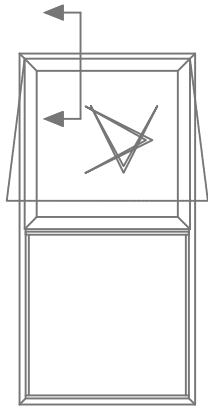

INSIDE

OUTSIDE

# AL UK 58BW TBT - Open Out TV Head

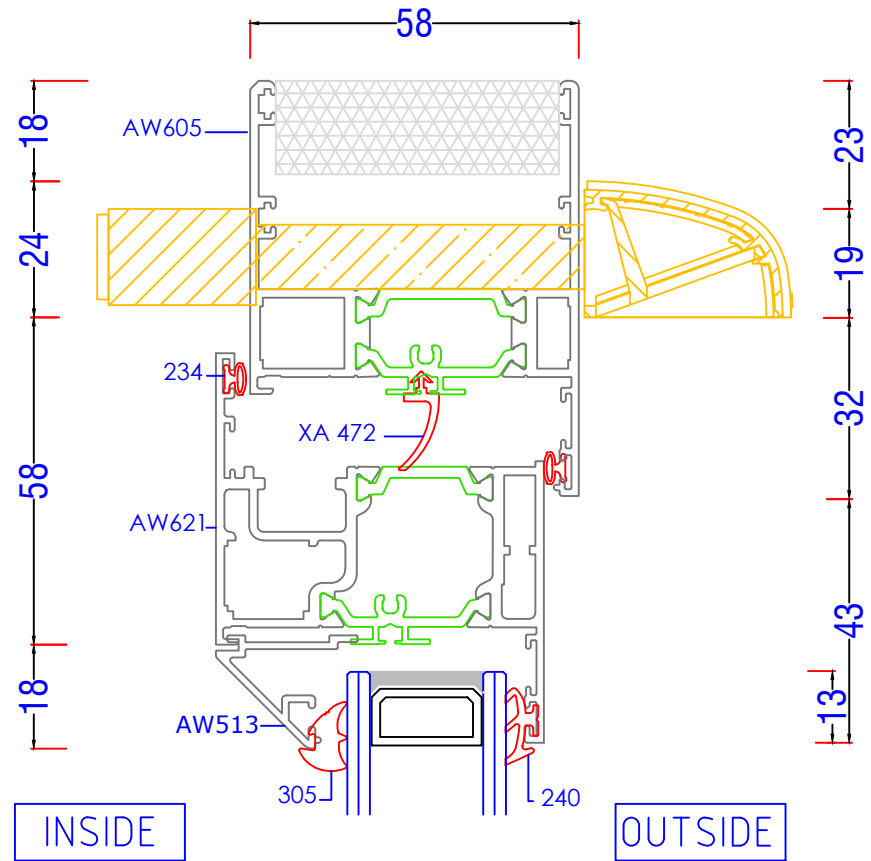
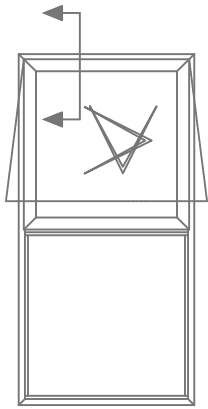

# AL UK 58BW TBT - 90mm Stub Cil

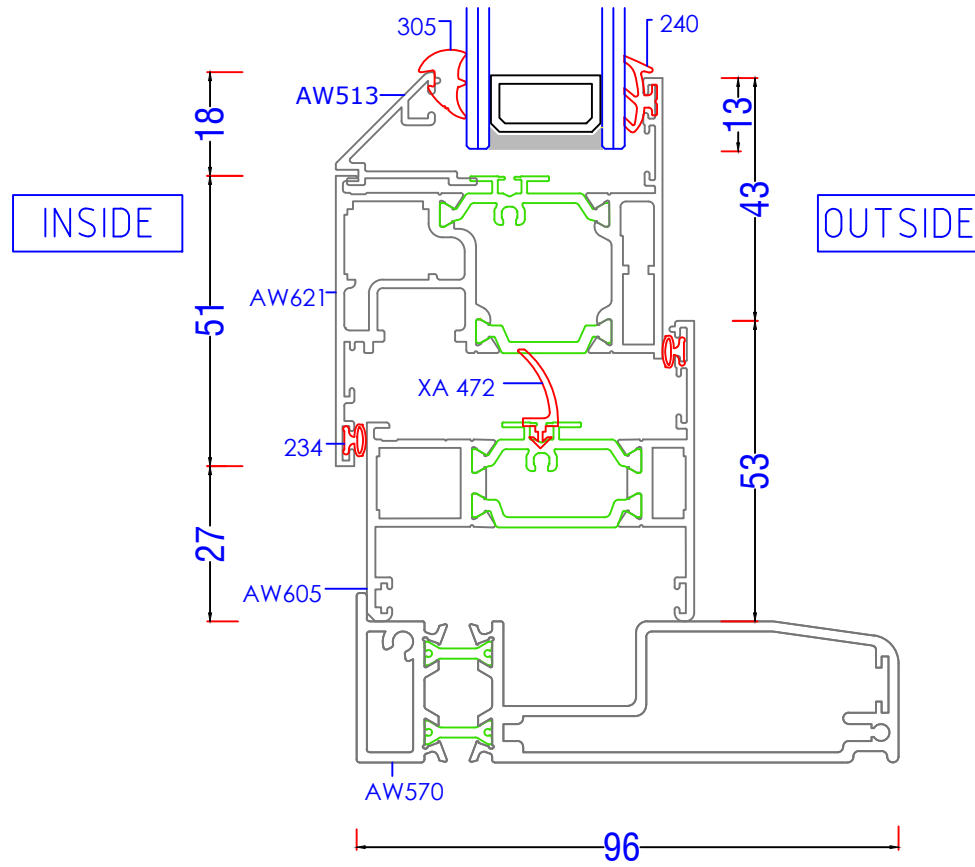
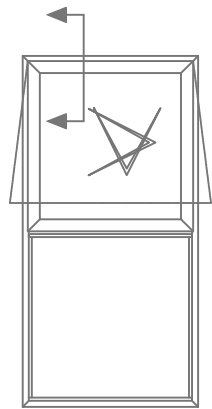

# AL UK 58BW TBT- 150mm Cil

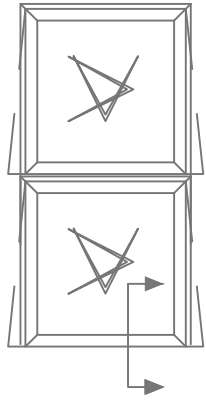

INSIDE

OUTSIDE

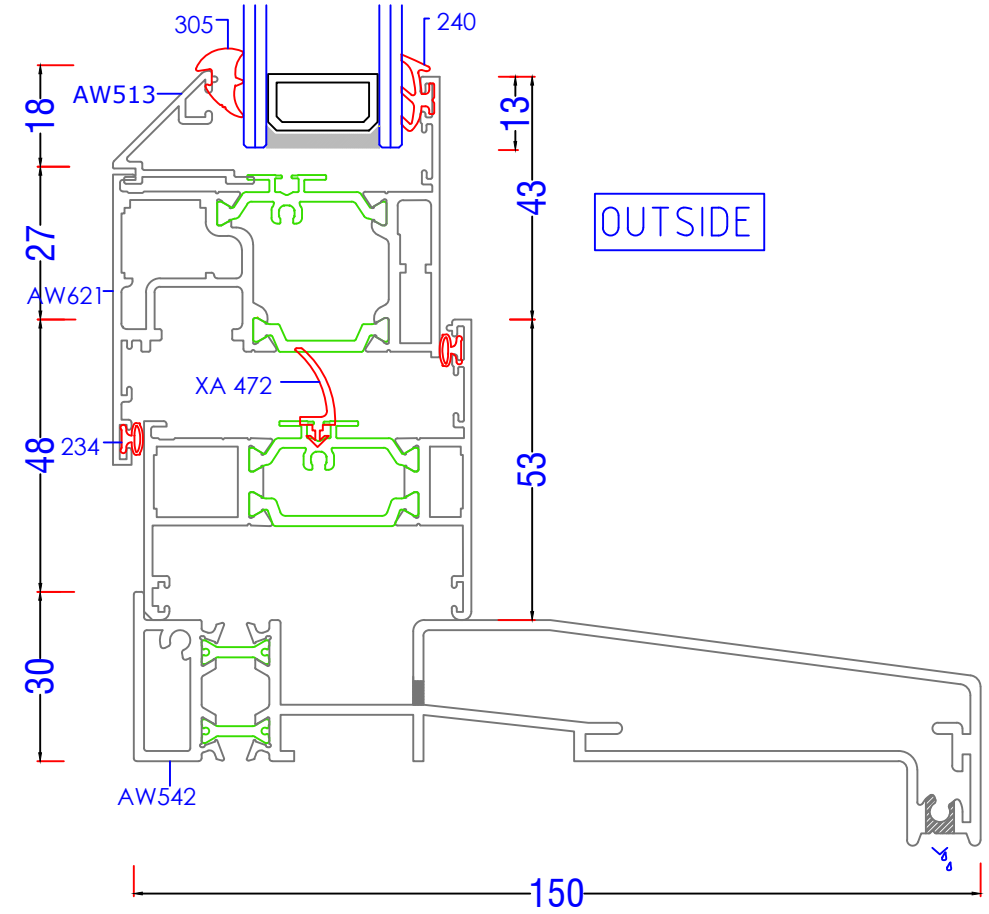

# AL UK 58BW TBT- 190mm Cil

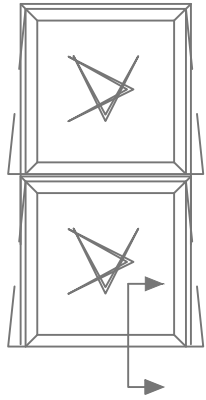

INSIDE

OUTSIDE

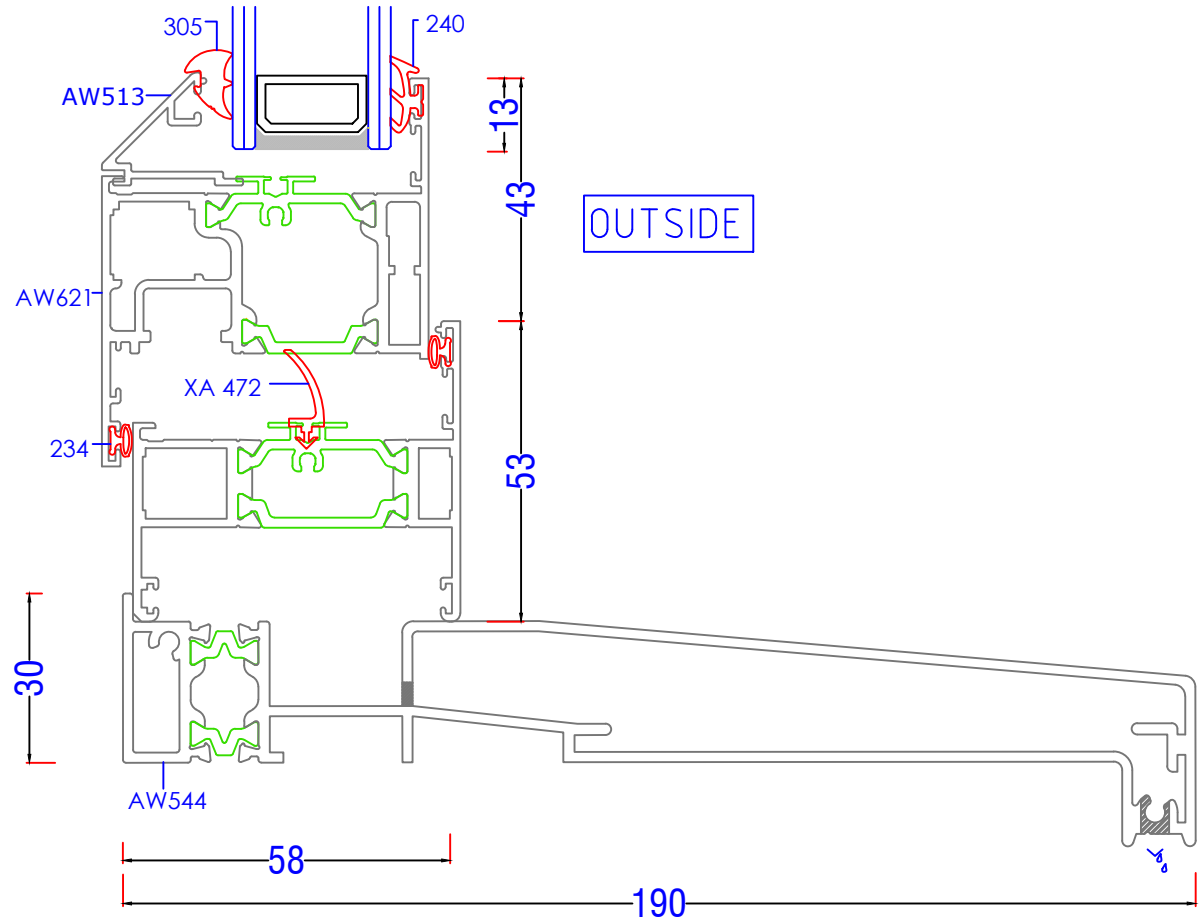

# AL UK 58BW TBT - Concealed Coupler

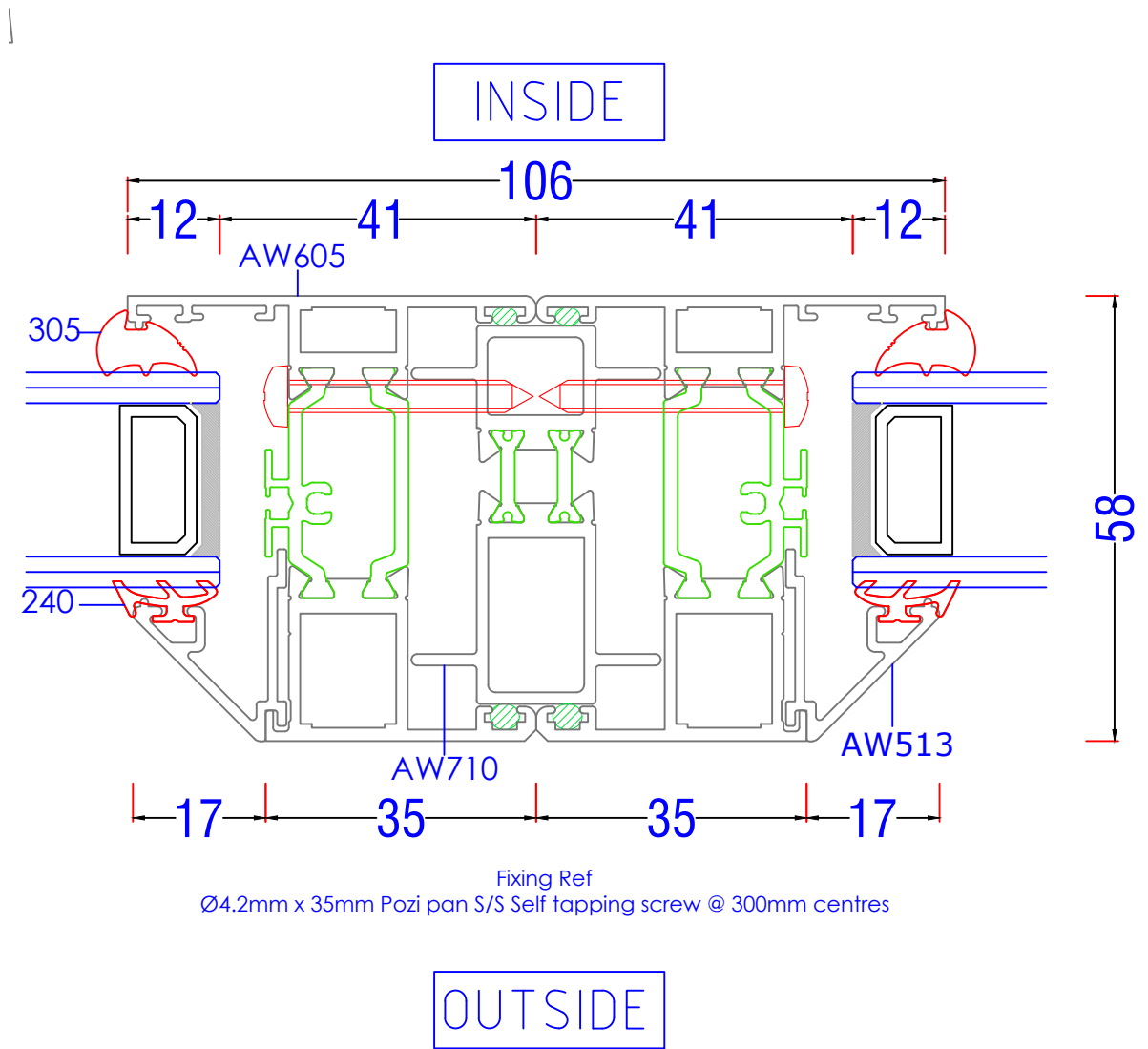
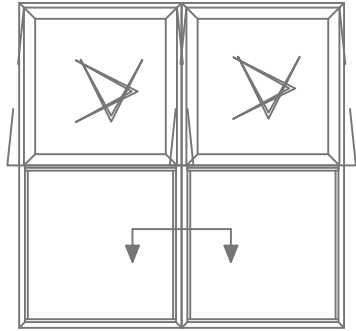

# AL UK 58BW TBT - 25/15 Coupler

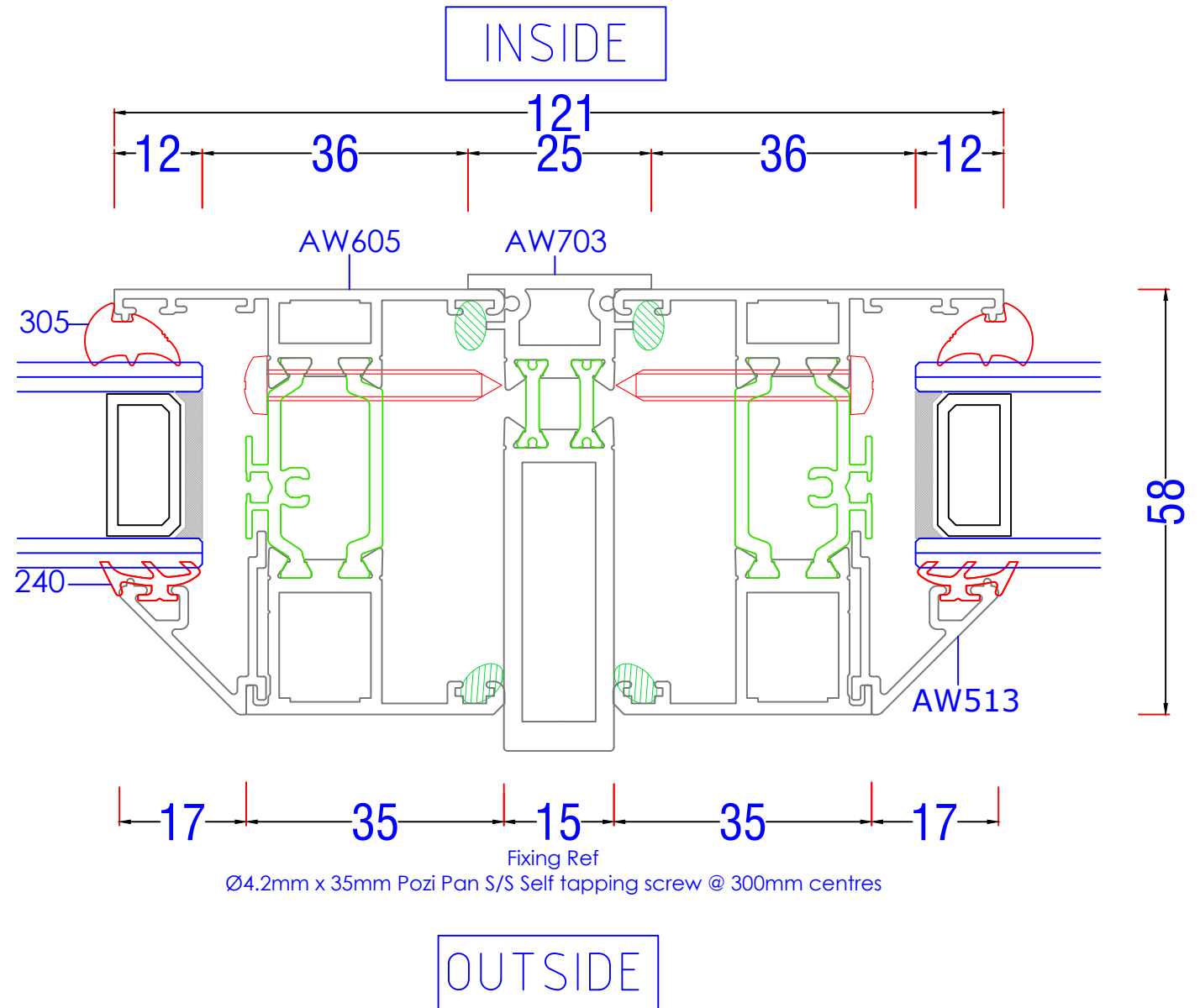
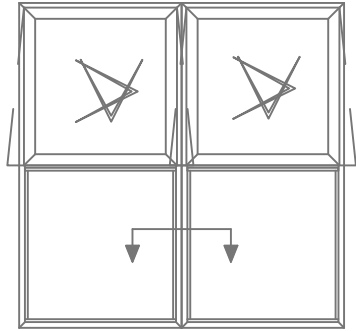

# AL UK 58BW TBT- 36/26 Coupler

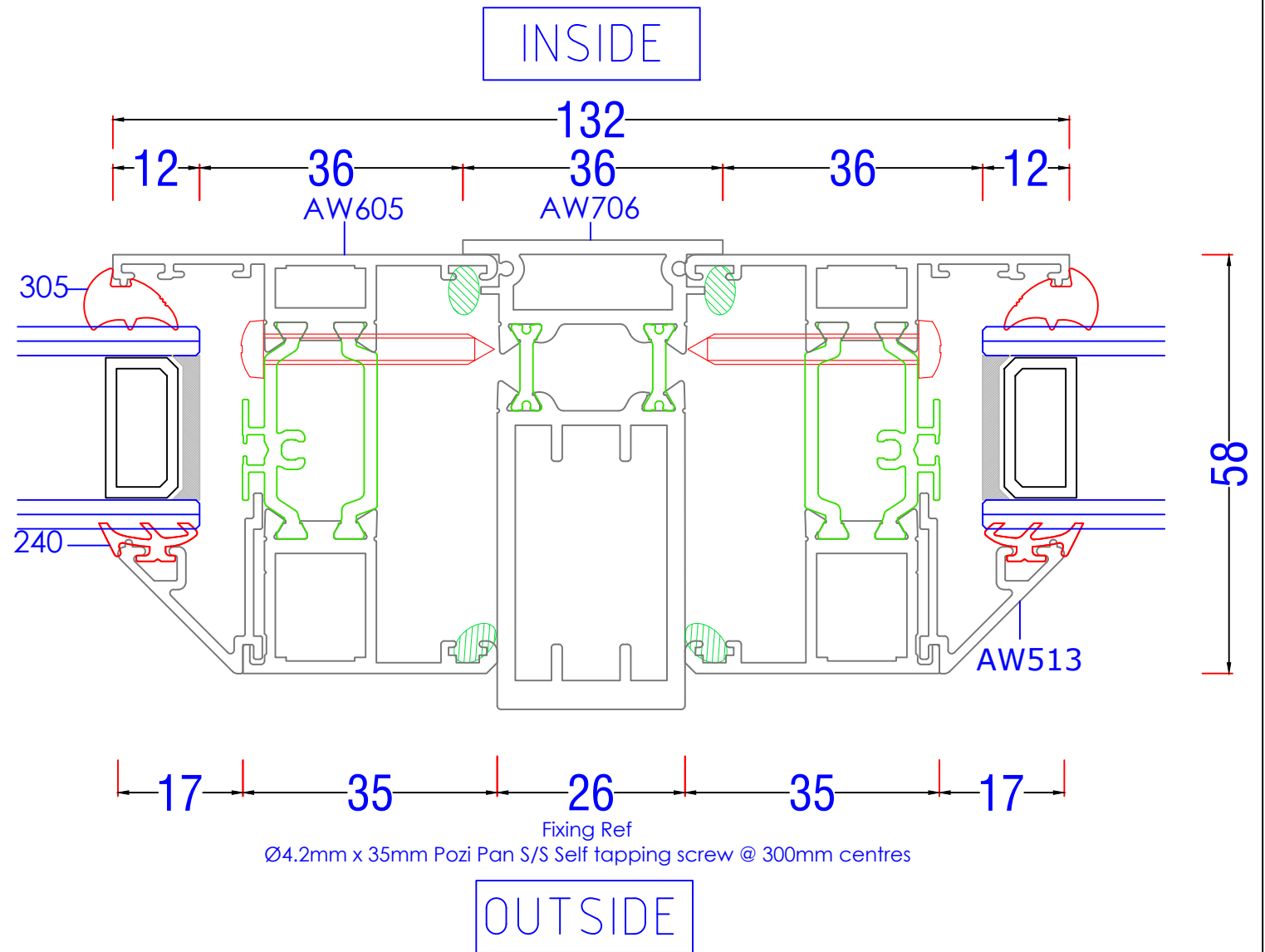
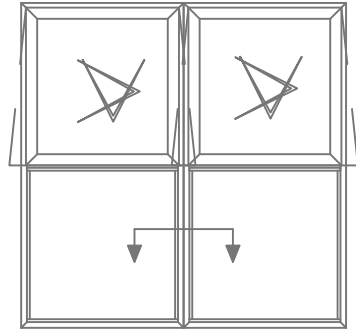



# AL UK 58BW TBT- Fixed to Opening Mullion

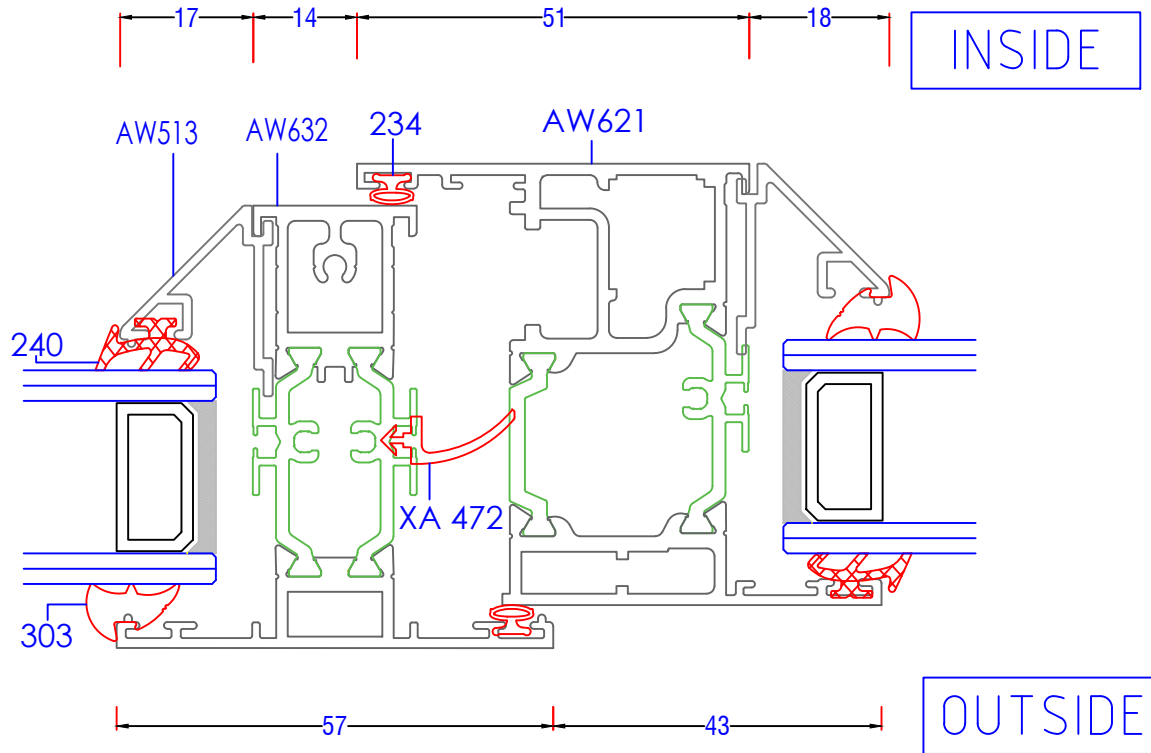
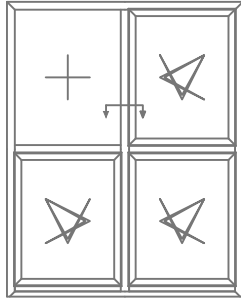

# AL UK 58BW TBT - Open to Open Mullion

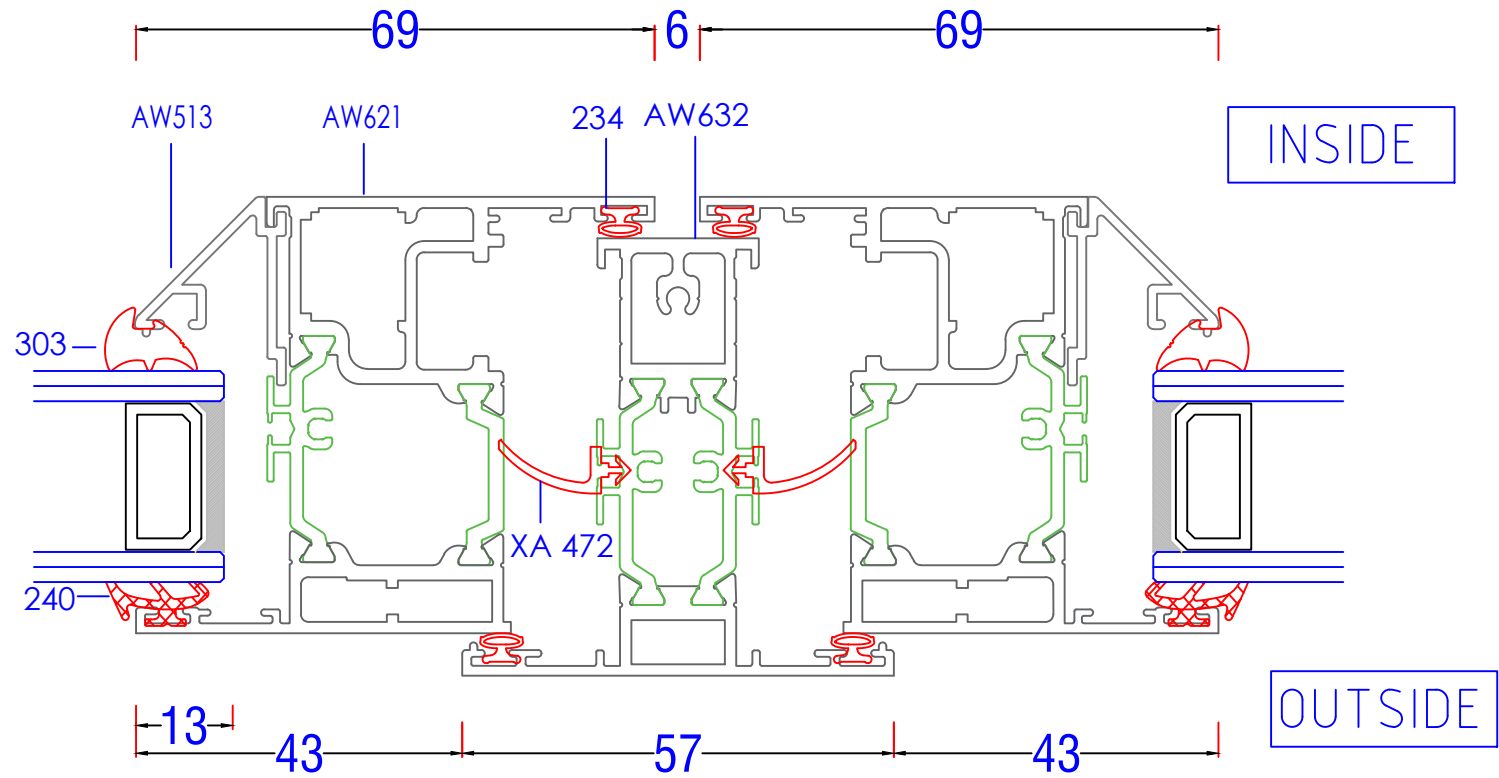
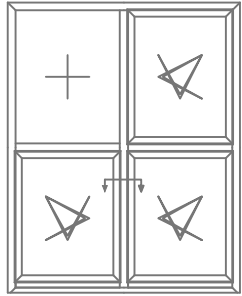

# AL UK 58BW TBT - Fixed to Fixed Transom

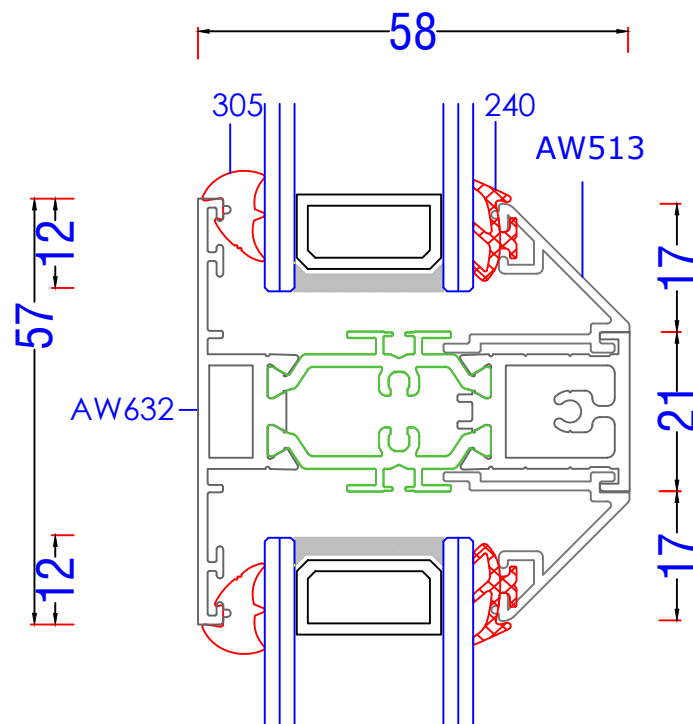
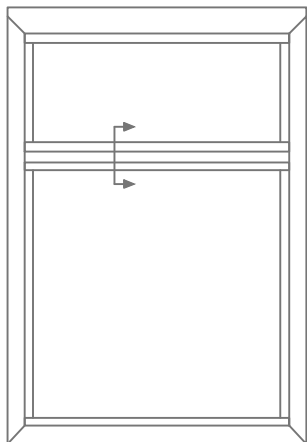

# AL UK 58BW TBT - Open to Fixed Transom

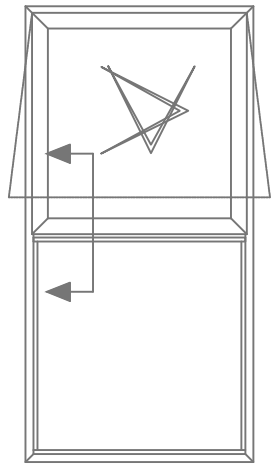

OUTSIDE

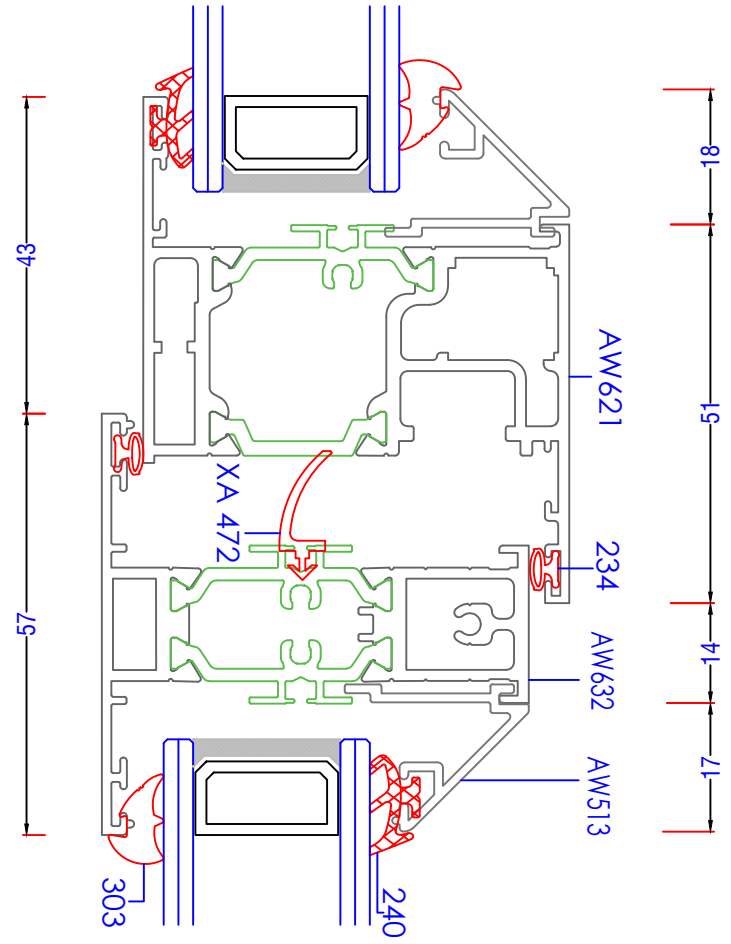

INSIDE

# AL UK 58BW TBT - Baypole

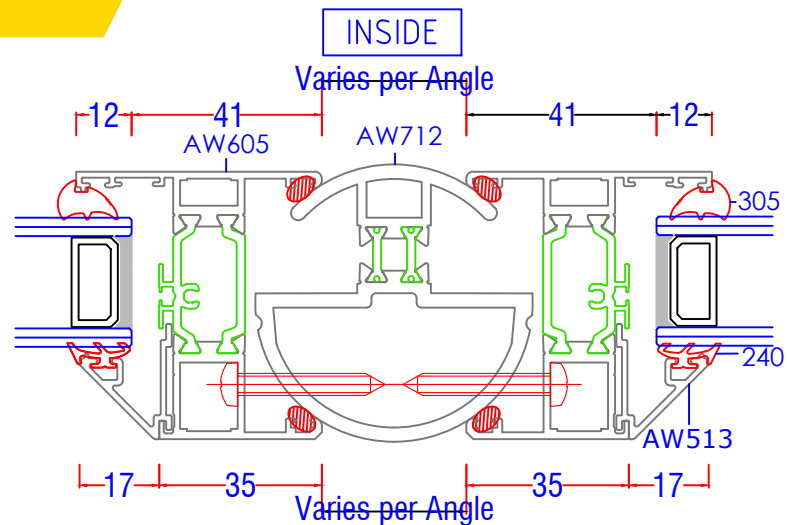
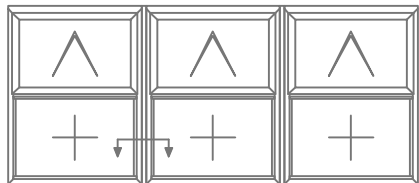

Fixing Ref Ø4.2mm x 35mm Pozi pan S/S Self tapping screw @ 300mm centres

OUTSIDE

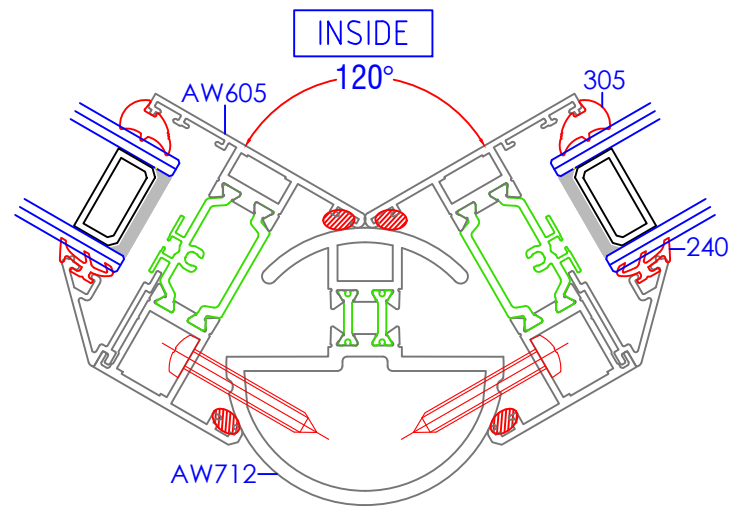

Fixing Ref Ø4.2mm x 35mm Pozi pan S/S Self tapping screw @ 300mm centres

OUTSIDE

# AL UK 58BW TBT - 90° Corner Post

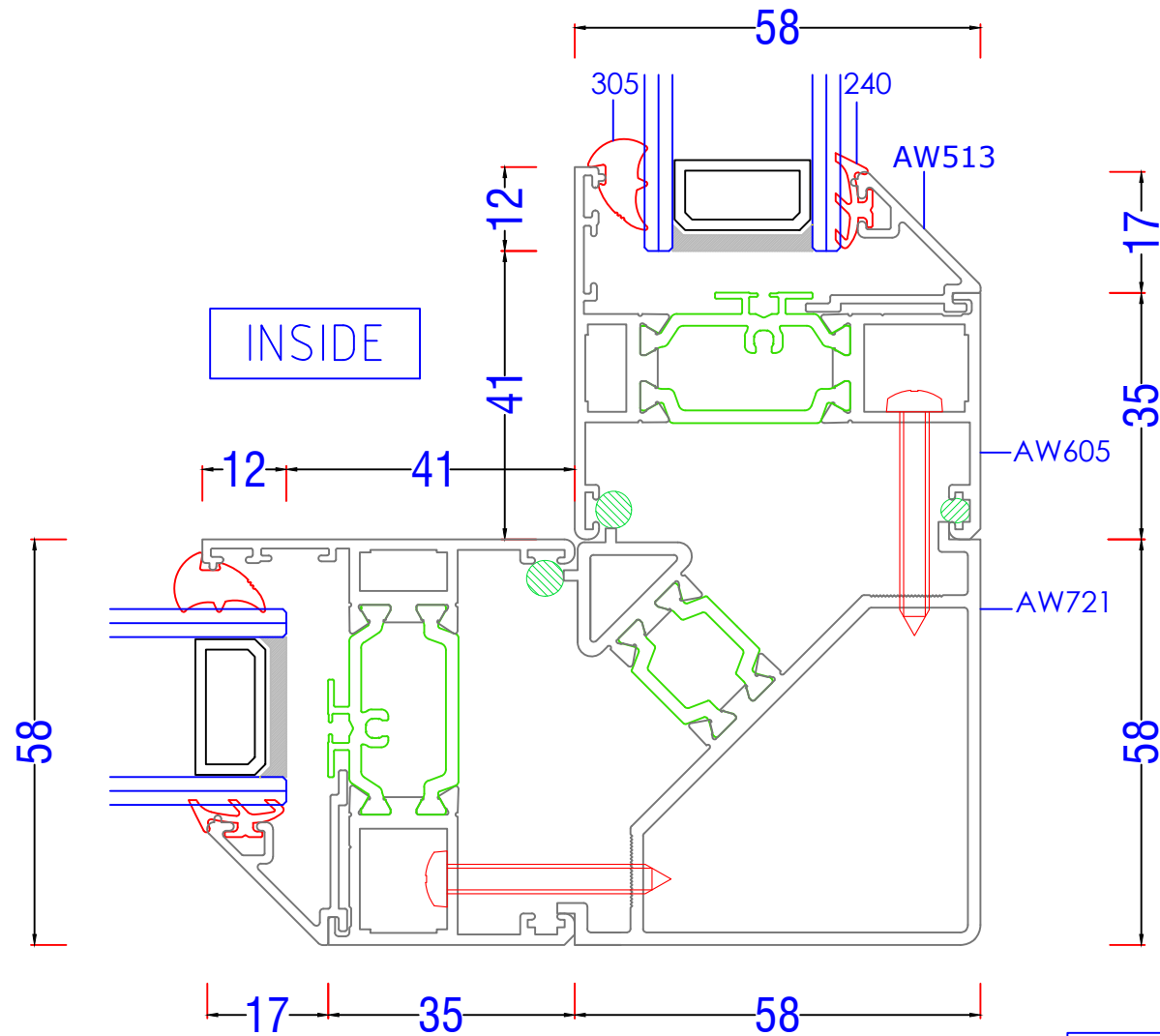
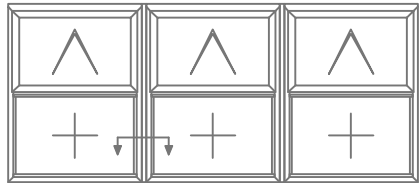

Fixing Ref  
 Ø4.2mm x 35mm Pozzi Pan S/S Self  
 tapping screw @ 300mm centres

# AL UK 58BW TBT- 20m Frame Extender

